



CAMRY
2 0 1 4 . 5

QUICK REFERENCE GUIDE

2014.5 Camry

This *Quick Reference Guide* is a summary of basic vehicle operations. It contains brief descriptions of fundamental operations so you can locate and use the vehicle's main equipment quickly and easily.

The *Quick Reference Guide* is not intended as a substitute for the *Owner's Manual* located in your vehicle's glove box. We strongly encourage you to review the *Owner's Manual* and supplementary manuals so you will have a better understanding of your vehicle's capabilities and limitations.

Your dealership and the entire staff of Toyota Motor Sales, U.S.A., Inc. wish you many years of satisfied driving in your new Camry.

A word about safe vehicle operations

This *Quick Reference Guide* is not a full description of Camry operations. Every Camry owner should review the *Owner's Manual* that accompanies this vehicle.

Pay special attention to the boxed information highlighted in color throughout the *Owner's Manual*. Each box contains safe operating instructions to help you avoid injury or equipment malfunction.

All information in this *Quick Reference Guide* is current at the time of printing. Toyota reserves the right to make changes at any time without notice.

INDEX

OVERVIEW

Engine maintenance	9
Fuel tank door release and cap	8
Hood release	9
Indicator symbols	4-5
Instrument cluster	4
Instrument panel	2-3
Keyless entry^{1,2}	6
Light control-Instrument panel	8
Smart Key system^{1,2}	7

FEATURES/OPERATIONS

Air Conditioning/Heating	18-19
Audio	21
Auto lock/unlock²	10
Automatic Transmission	10
Bottle holders	23
BSM (Blind Spot Monitor)	17
Clock	18
Cruise control	16
Cup holders	23
Garage door opener (HomeLink [®]) ³	16
iPod [®] /USB/AUX port	22
Lights¹ & turn signals	15
Moonroof	12
Pairing a Bluetooth [®] device	20
Parking brake	11
Power outlets-12V DC	14
Rear view monitor system	17
Seat adjustments-Front	13
Seat adjustments-Rear	13
Seat heaters	19
Seats-Head restraints	12
Steering lock release	11
Steering wheel switches and Telephone controls	20
Tilt and telescopic steering wheel	11
Traffic	22
Weather	22
Windows-Power	12
Windshield wipers & washers	14

SAFETY AND EMERGENCY FEATURES

Door locks	24
Doors-Child safety locks	24
Floor mat installation	28
Safety Connect	25
Seat belts	24
Seat belts-Shoulder belt anchor	25
Spare tire & tools	26
Star Safety System [™]	27-28
Trunk-Internal release	26

¹ Visit your Toyota dealer for information on customizing this feature.

² Programmable by customer. Refer to the Owner's Manual for instructions and more information.

³ HomeLink[®] is a registered trademark of Johnson Controls, Inc.

OVERVIEW

Instrument panel

Steering wheel controls

Type A

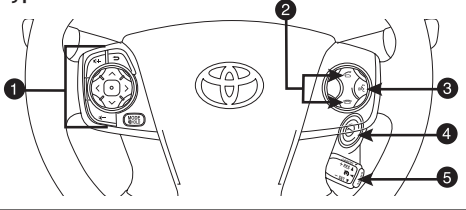

Type B

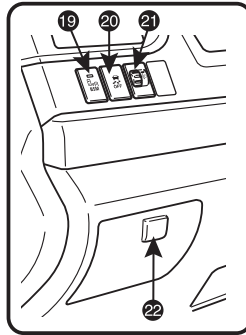
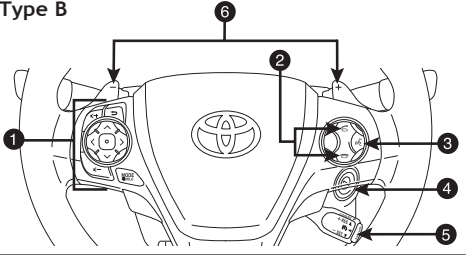

Automatic Air Conditioning

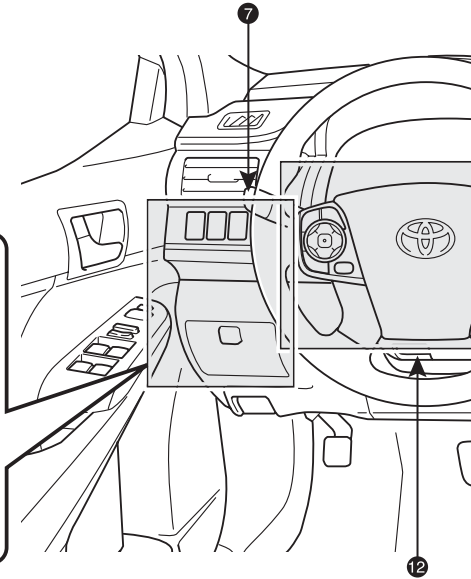
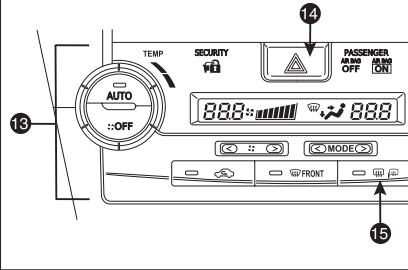

- ① Steering wheel audio controls^{1,2,3}
- ② Telephone controls^{1,2,3}
- ③ Voice command button^{1,2,3}
- ④ Ignition switch (standard key)¹
- ⑤ Cruise control
- ⑥ Paddle shift switches¹
- ⑦ Headlight and turn signal controls/Headlight, turn signal and front fog light¹ controls
- ⑧ Wiper and washer controls
- ⑨ Clock
- ⑩ Audio system¹/Navigation system^{1,2}/Display audio system^{1,3}
- ⑪ “ENGINE START STOP” button (Smart Key)¹
- ⑫ Tilt and telescopic steering lock release
- ⑬ Air Conditioning controls
- ⑭ Emergency flasher button
- ⑮ Outside rearview mirror¹/Rear window defogger button

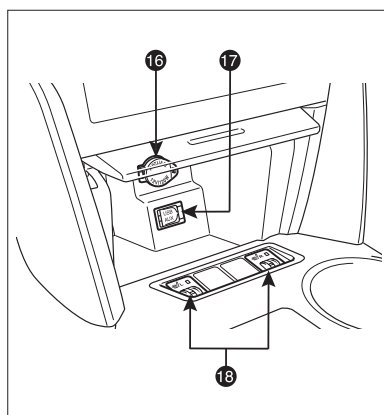
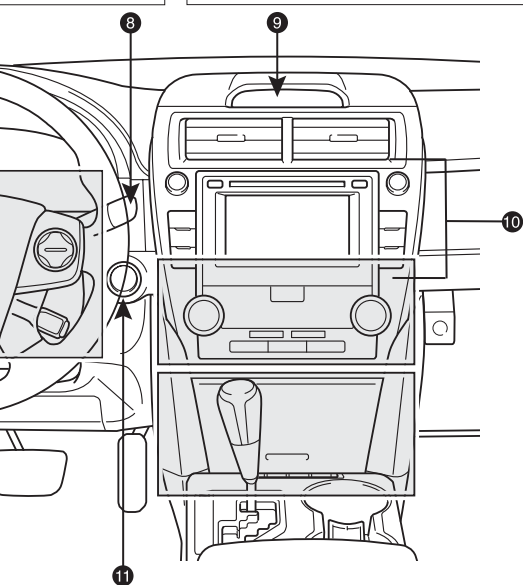
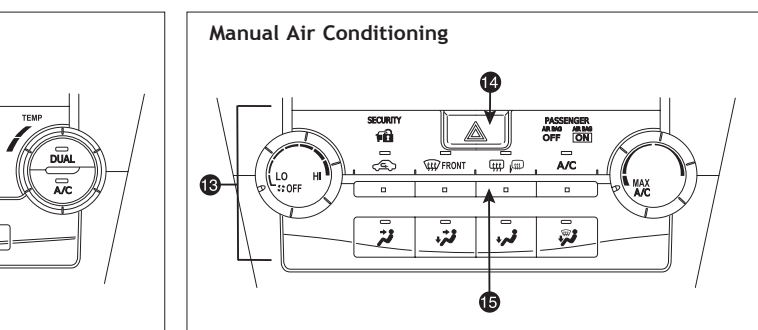

- 16 12V DC power outlet
- 17 USB/AUX port
- 18 Seat heater controls¹
- 19 BSM (Blind Spot Monitor) main switch¹
- 20 VSC OFF switch
- 21 Headlight leveling dial¹
- 22 Coin holder

¹ If equipped

² For details, refer to the “Navigation System Owner’s Manual.”

³ For details, refer to the “Display Audio System Owner’s Manual.”

NOTE: For vehicles equipped with Entune™, please consult the “Navigation System With Entune Quick Reference Guide” or www.toyota.com/entune.

Instrument cluster

Type A

Type B

- ① Service indicators and reminders
- ② Tachometer
- ③ Speedometer
- ④ Fuel gauge
- ⑤ Average fuel consumption meter
- ⑥ Current fuel consumption gauge (if equipped)
- ⑦ Display change button
- ⑧ Odometer/Trip meter/Average fuel consumption display
- ⑨ Engine coolant temperature display/Instrument panel light control display
- ⑩ Odometer/Trip meter/Outside temperature/Average fuel consumption/Current fuel consumption display
- ⑪ Outside temperature display
- ⑫ Shift position/Shift range display
- ⑬ Instrument panel light control button



























Indicator symbols

For details, refer to “Indicators and warning lights,” Section 2-2, 2014 Owner’s Manual.

BRAKE Brake system warning¹

 Driver/Front passenger seat belt reminder (alarm will sound if speed is over 12 mph)

¹ If indicator does not turn off within a few seconds of starting engine, there may be a malfunction. Have vehicle inspected by your Toyota dealer.





	Electric power steering system warning ¹
	Charging system warning ¹
	SRS AIRBAG ON/OFF indicator
	Low engine oil pressure warning ¹
	Malfunction/Check Engine indicator ¹
	Maintenance required reminder ¹
	Low fuel level warning
	Open door warning
	SRS airbag warning ¹
BSM 	Blind Spot Monitor warning/Blind Spot Monitor outside rearview mirror indicators
	Low Tire Pressure Warning ¹
	Low windshield washer fluid warning ¹
	Theft deterrent/Engine immobilizer system indicator
	 Headlight low/high beam indicator
	Turn signal indicator
	Front fog light indicator
	Slip indicator ¹
	Vehicle Stability Control OFF indicator ¹
TRAC OFF 	Traction Control OFF indicator ¹
	SET Cruise control indicator ² /Cruise control SET indicator ²
ABS 	Anti-lock Brake System warning ¹
	Smart Key system indicator ³
D S 	Shift position and shift range indicators
ECO 	Eco Driving indicator ¹
	 High engine coolant temperature warning

² If this light flashes, refer to "Cruise control," Section 2-4, 2014 Owner's Manual.



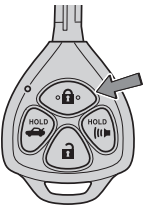

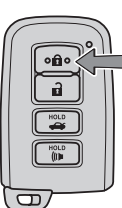
³ Light flashes in yellow to indicate a malfunction. Light flashes quickly in green to indicate that the steering lock has not been released.

Keyless entry (if equipped)

Locking operation

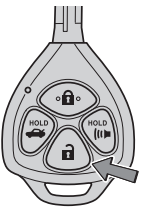

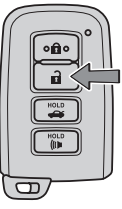
Type A	Type B	Type C	
			<p>Push</p> 

Unlocking operation

Type A	Type B	Type C	
			<p>Push ONCE: Driver door TWICE: All doors</p> 

NOTE: If a door is not opened within 60 seconds of unlocking, all doors will relock for safety.

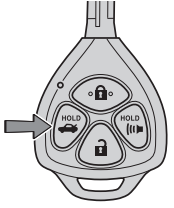
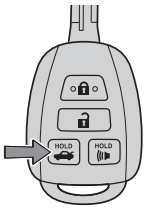
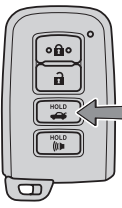
Trunk lid

Type A	Type B	Type C	
			<p>Push and hold</p> 

Panic button

	<p>Push and hold</p> 
---	---

Smart Key system (if equipped)

Start function

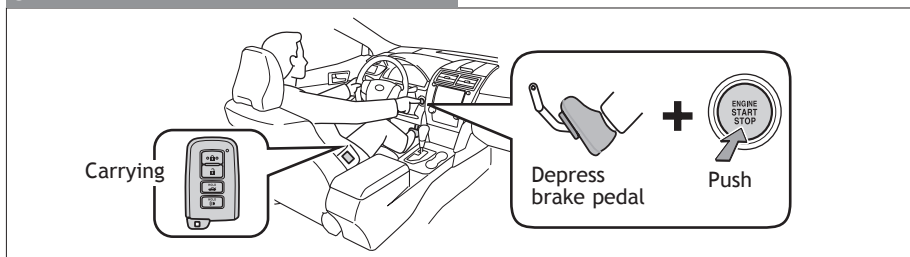

NOTE: Gear shift lever must be in Park and brake pedal depressed.

Power (without starting engine)

Without depressing the brake pedal, pressing the “ENGINE START STOP” switch will change the operation mode in succession from:

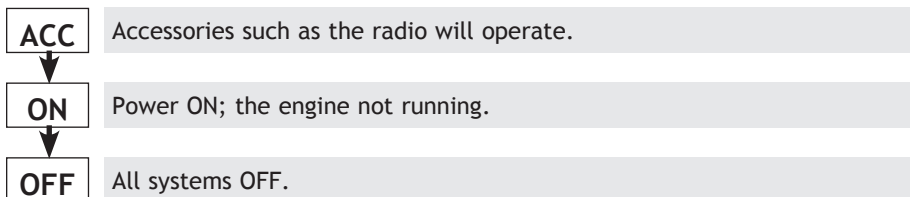

Locking operation

Front door lock

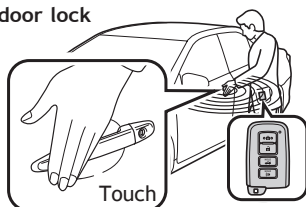

Unlocking operation

Front door unlock*

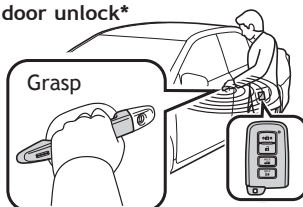

Trunk lock/unlock

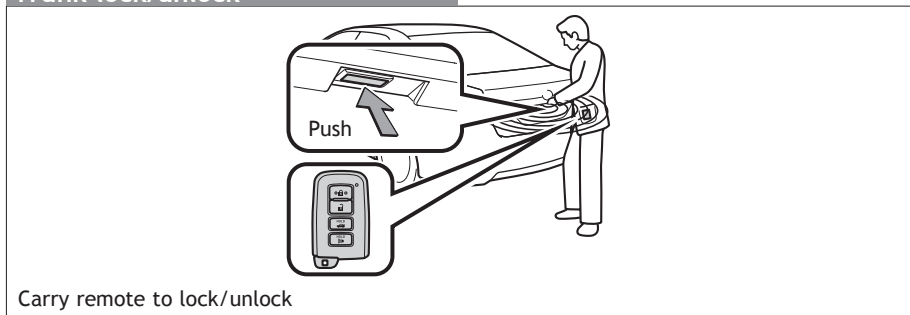

* Driver door unlocking function can be programmed to unlock driver door only, or all doors. Grasping front passenger door handle will unlock all doors.

NOTE: Doors may also be locked/unlocked using remote.

Fuel tank door release and cap

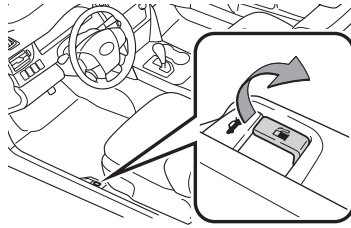

Pull up

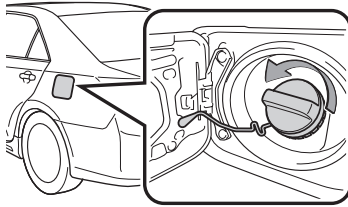

Turn to open

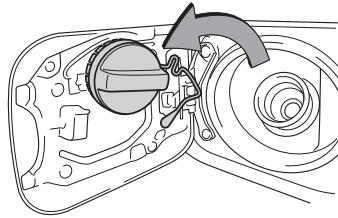

Store

NOTE: Tighten until one click is heard. If the cap is not tightened enough, Check Engine “” indicator may illuminate.

Light control-Instrument panel

Type A

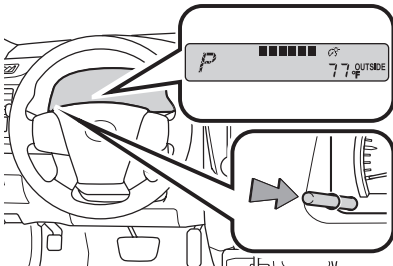

Brightness control

Type B

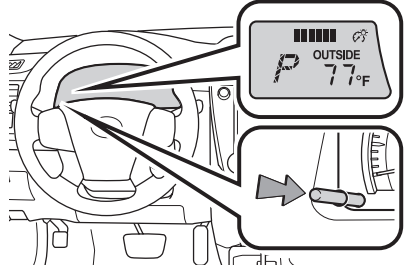

Brightness control

Hood release

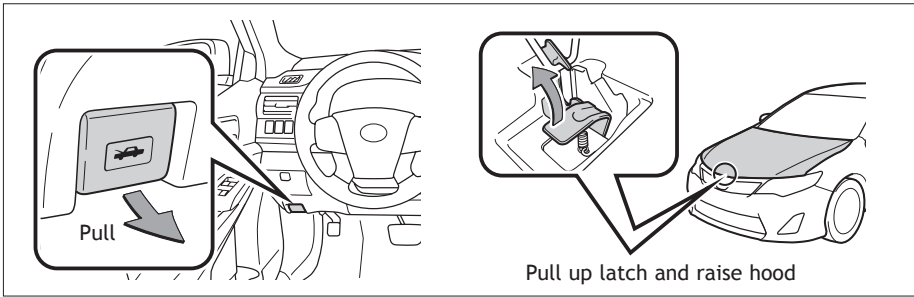

Engine maintenance

4 cylinder (2AR-FE) engine

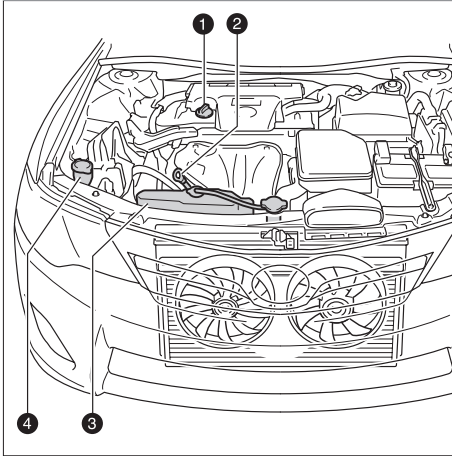

6 cylinder (2GR-FE) engine

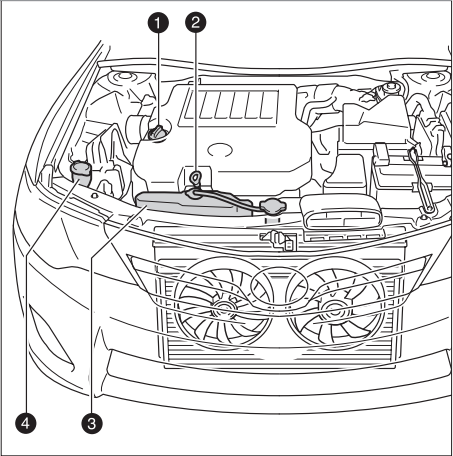

- ① Engine oil filler cap
- ② Engine oil level dipstick
- ③ Engine coolant reservoir
- ④ Windshield washer fluid tank

NOTE: Regularly scheduled maintenance, including oil changes, will help extend the life of your vehicle and maintain performance. Please refer to the "Warranty Maintenance Guide."

FEATURES/OPERATIONS

Auto lock/unlock

Automatic door locks can be programmed to operate in four different modes, or turned OFF.

- Doors lock when shifting from Park.
- Doors lock when the vehicle speed goes above approximately 12 mph.
- Doors unlock when shifting into Park.

Vehicles without Smart Key system

-Doors unlock when the ignition switch is set from “ON” to “ACC” or “LOCK” and driver’s door is opened.

Vehicles with Smart Key system

-Doors unlock when the “ENGINE START STOP” switch is set to OFF and driver’s door is opened.

Refer to the *Owner’s Manual* for more details.

Automatic Transmission

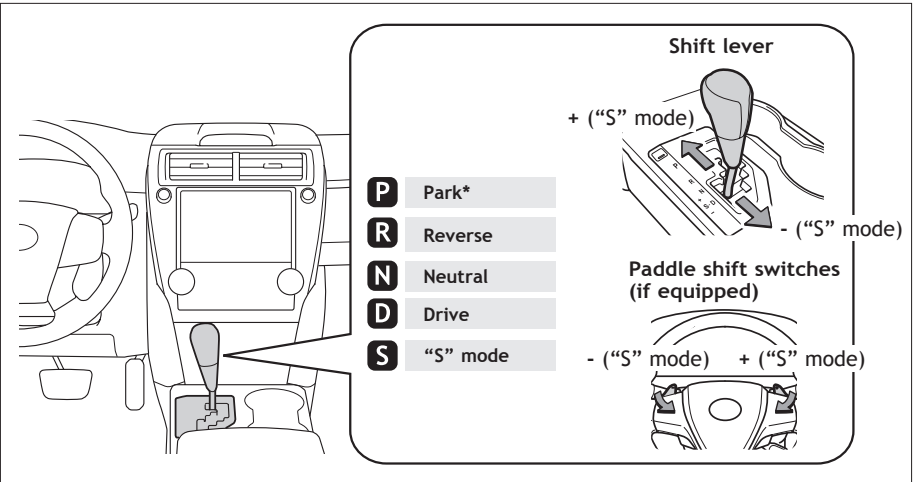

* The “ENGINE START STOP”/ignition switch must be “ON” and the brake pedal depressed to shift from Park.

“S” (Sequential) mode

Shift the shift lever to “S” position from “D” position.

- +: Upshifting
- : Downshifting

Downshifting increases power going uphill, or provides engine braking downhill. For best fuel economy during normal driving conditions, always drive with the shift lever in the “D” position.

Steering lock release

Smart Key system*

Without Smart Key system

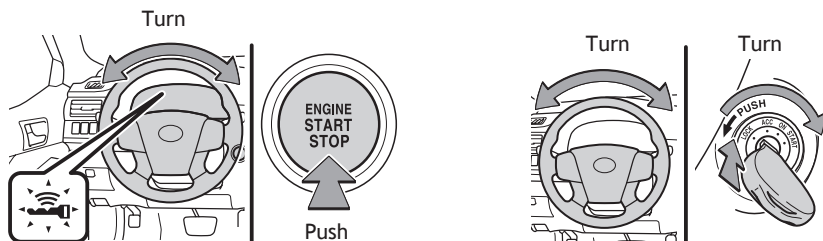

* Gently turn steering wheel while pressing the “ENGINE START STOP” switch. If the lock does not release, the Smart Key system indicator will flash quickly (green).

Tilt and telescopic steering wheel

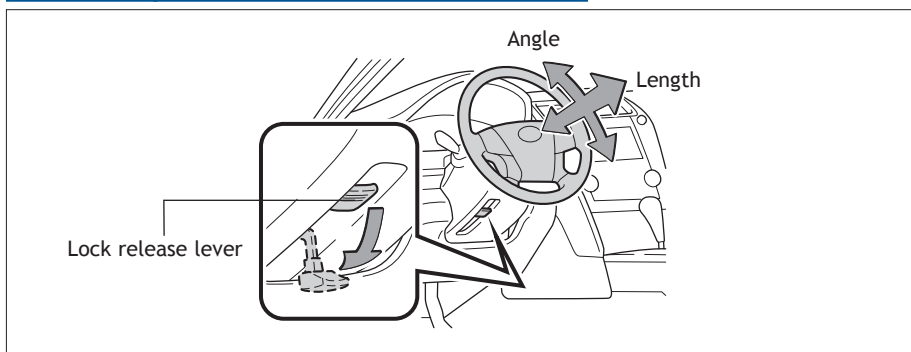

Hold wheel, push lever down, set angle and length, and return lever.

NOTE: Do not attempt to adjust while the vehicle is in motion.

Parking brake

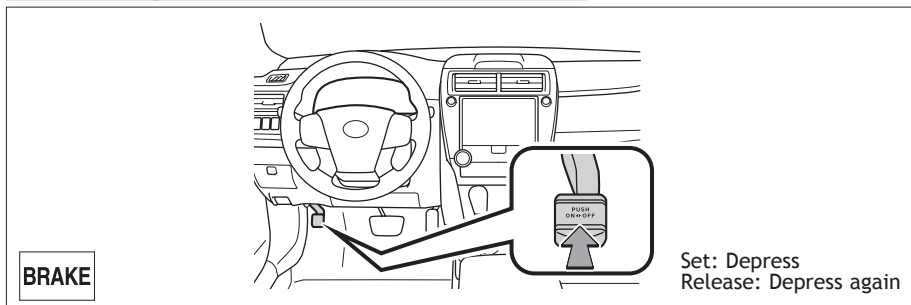

Set: Depress
Release: Depress again

Windows-Power

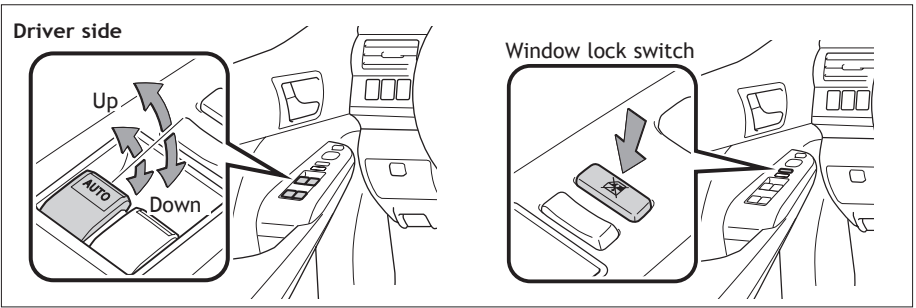

Automatic operation (driver's window only) Push the switch completely down or pull it completely up and release to fully open or close. To stop the window partway, operate the switch in the opposite direction.

Window lock switch Deactivates all passenger windows. Driver's window remains operable.

Moonroof (if equipped)

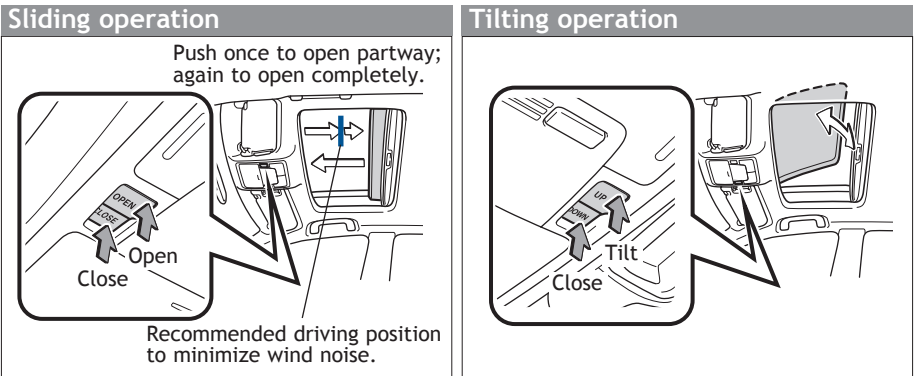

Push once to open; moonroof will automatically stop at the recommended position. Push again to open completely.

Seats-Head restraints

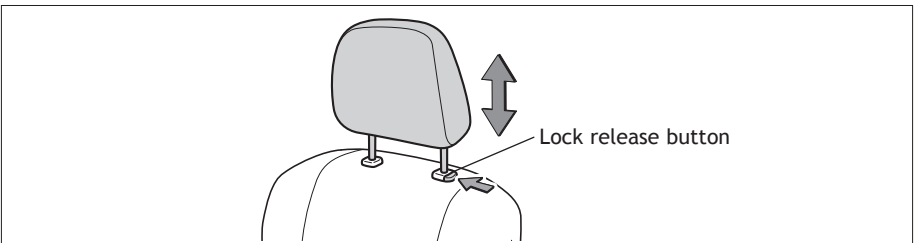

Seat adjustments-Front

Manual seat



Power seat

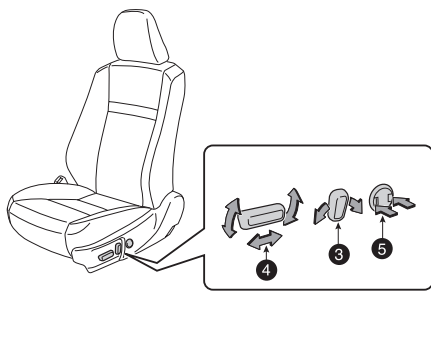

- ❶ Seat position (forward/backward)
- ❷ Height crank (driver side only)
- ❸ Seatback angle
- ❹ Seat position, cushion angle (driver side only) and height (driver side only)
- ❺ Lumbar support (driver side only)

Seat adjustments-Rear

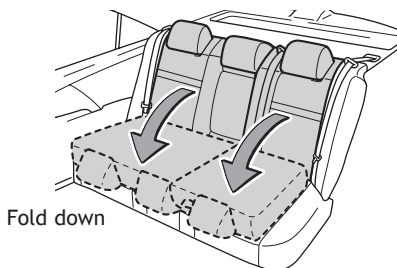
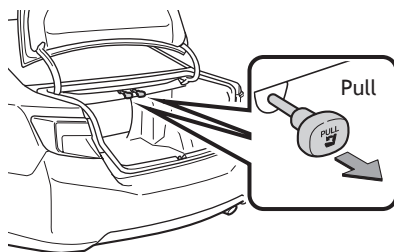

Refer to the *Owner's Manual* for more details.

Windshield wipers & washers

Type A

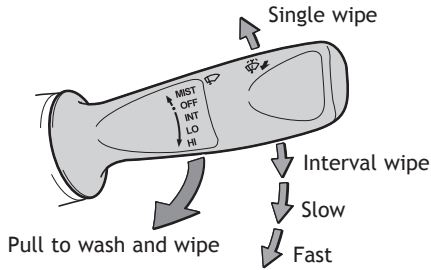

Type B

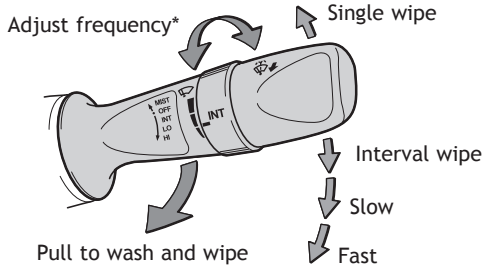

* Intermittent windshield wiper frequency adjustment
Rotate to increase/decrease wipe frequency.

Power outlets-12V DC

Front console

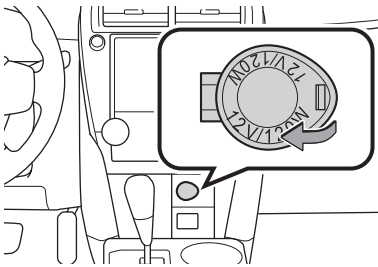

Center console (if equipped)

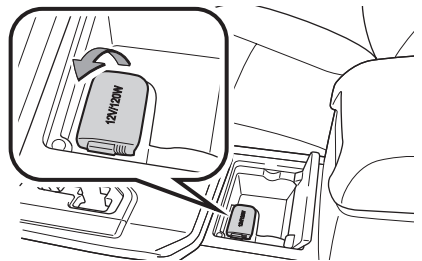

The “ENGINE START STOP” switch/ignition switch must be in the “ACC” or “ON” position for use.

Lights & turn signals

Headlights

Type A

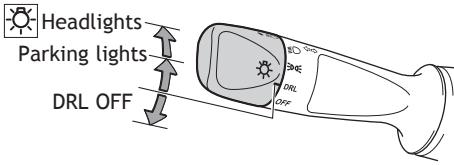

Type B

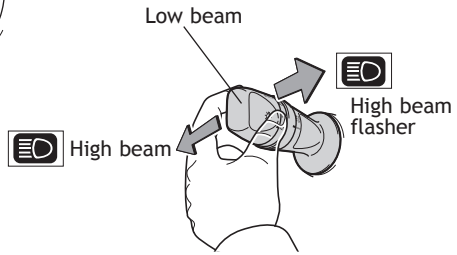
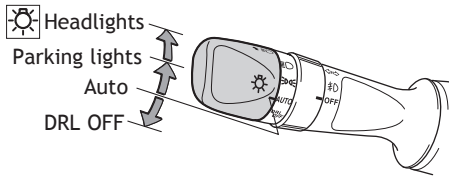

- Daytime Running Light system (DRL)** Automatically turns on the headlights at a reduced intensity.
- Automatic light cut off system** Automatically turns lights off after 30-second delay, or lock switch on remote may be pushed after locking.

Front fog lights (if equipped)

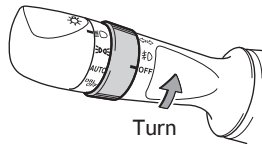

Front fog lights come on only when the headlights are on low beam.

Turn signals

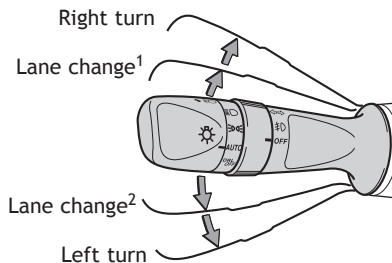

- ¹ The right hand signals will flash three times.
- ² The left hand signals will flash three times.

Garage door opener (HomeLink®)* (if equipped)

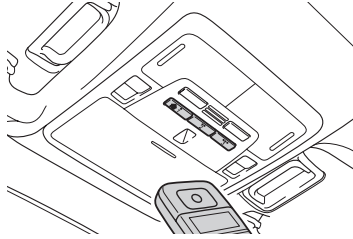

Garage door openers manufactured under license from HomeLink®* can be programmed to operate garage doors, estate gates, security lighting, etc.

Refer to “Garage door opener,” Section 3-5 in the *Owner’s Manual* for more details.

For programming assistance, contact HomeLink® at 1-800-355-3515, or visit <http://www.homelink.com>.

* HomeLink® is a registered trademark of Johnson Controls, Inc.

Cruise control

Turning system ON/OFF

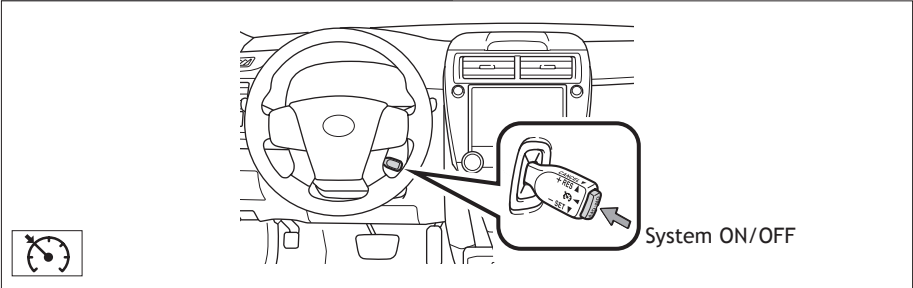

Functions

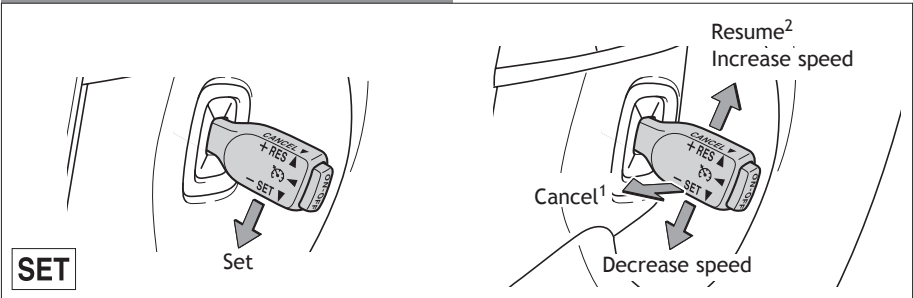

¹ The set speed may also be cancelled by depressing the brake pedal.
² The set speed may be resumed once vehicle speed exceeds 25 mph.

BSM (Blind Spot Monitor)(if equipped)

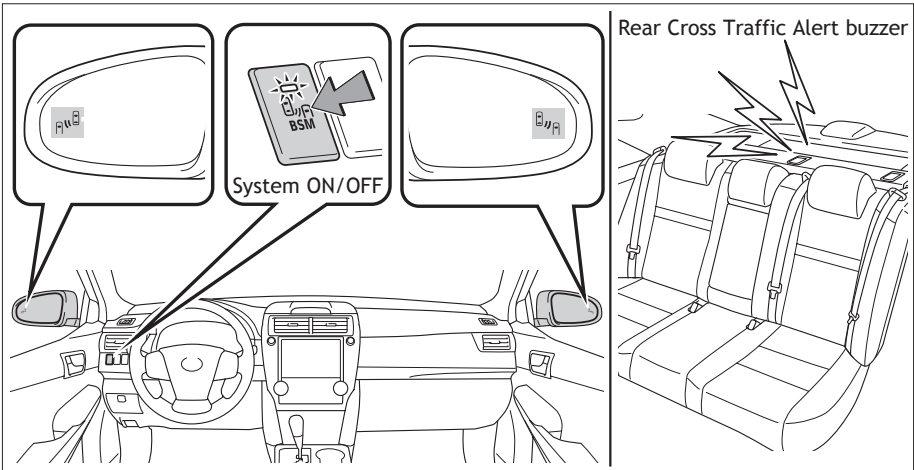

The Blind Spot Monitor is a system that has two functions:

- The Blind Spot Monitor function (assists the driver in decision-making when changing lanes)
- The Rear Cross Traffic Alert function (assists the driver when backing up)

The Blind Spot Monitor function uses radar sensors to detect vehicles that are traveling in an adjacent lane in the area that is not reflected in the outside rear view mirror (the blind spot), and advises the driver of the vehicles existence via the outside rear view mirror indicator.

Refer to the *Owner's Manual* for more details on this system before attempting to use it.

Rear view monitor system

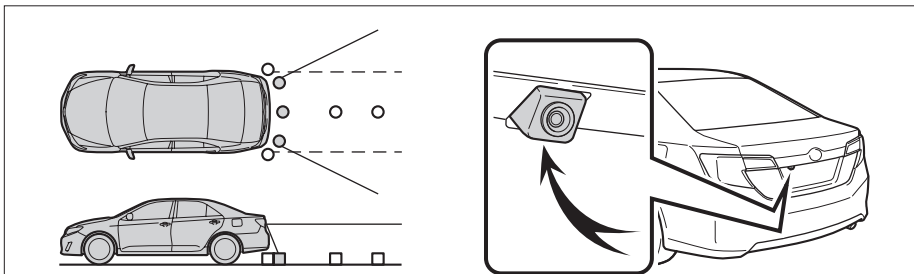

The rear view monitor system displays an image of the view from the bumper of the rear area of the vehicle. The camera for the rear view monitor system is located above the license plate.

To adjust the image on the rear view monitor screen, press the "SETUP" button and select "Display" on the "Setup" screen. Select "Camera" to adjust the screen contrast and brightness.

Refer to the *Owner's Manual* for more details on this system.

Clock

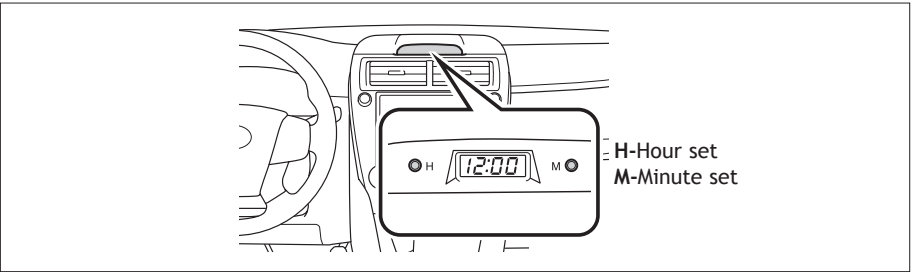

Air Conditioning/Heating

Automatic Air Conditioning

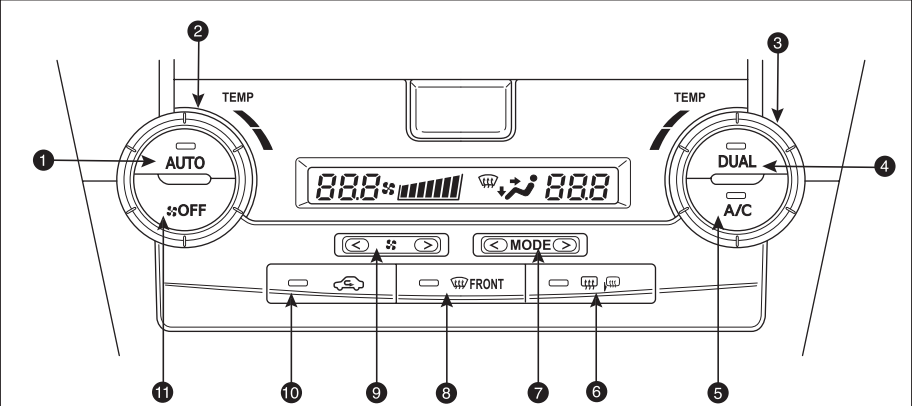

- ① Automatic climate control ON
Adjusting the temperature setting will cause the airflow vents, air intake and fan to adjust automatically.
- ② Temperature selector (driver side)
- ③ Temperature selector (passenger side)
- ④ “DUAL” button
Indicator ON: Separate temperature settings for driver and passengers.
Indicator OFF: Synchronized temperature settings for driver and passengers.
- ⑤ Air Conditioning ON/OFF
- ⑥ Outside rearview mirror/Rear defogger
- ⑦ Airflow vent
In “” or “” mode, use fresh air (“” indicator OFF) to reduce window fogging.
- ⑧ Windshield airflow/defogger
- ⑨ Fan speed
- ⑩ Recirculate cabin air (fresh air when OFF)
- ⑪ Climate control OFF

Manual Air Conditioning

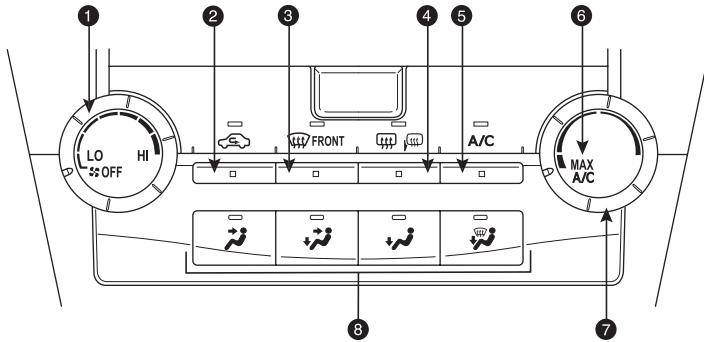

- ① Fan speed
- ② Recirculate cabin air (fresh air when OFF)
- ③ Windshield airflow/defogger
- ④ Outside rearview mirror defoggers*/Rear defogger
- ⑤ Air Conditioning ON/OFF
Use fresh air to quickly cool interior, then change to recirculate for cooler air.
- ⑥ Select for maximum cooling. Air intake will automatically be set to recirculate. It is not possible to change intake to fresh, or to turn A/C OFF in this mode.
- ⑦ Temperature selector
- ⑧ Airflow vent
In “” mode, use fresh air (“” indicator OFF) to reduce window fogging. “” mode uses fresh air only.

* If equipped

Seat heaters (if equipped)

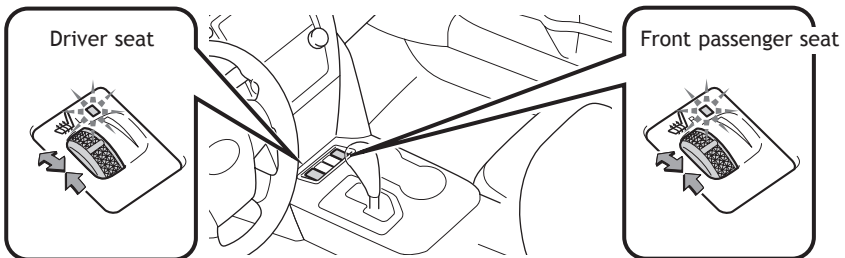

Steering wheel switches and Telephone controls (Bluetooth®)

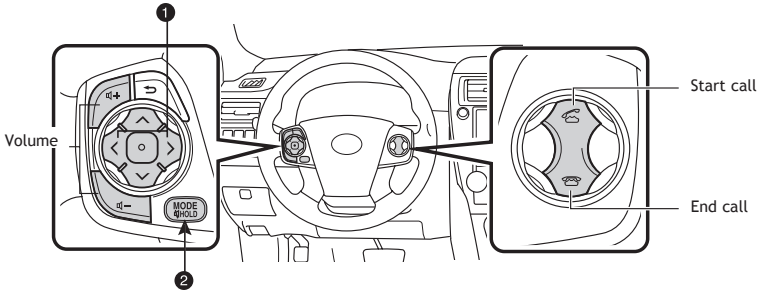

- 1 “**▲ ▼**” Use to search within the selected audio medium (radio, CD, iPod®, etc.).
- 2 “**MODE**” Push to turn audio ON and select an audio mode. Push and hold to turn the audio OFF.

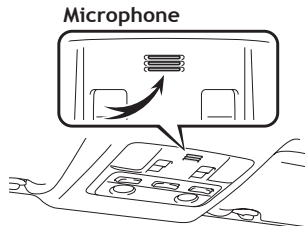

Bluetooth® technology allows dialing or receipt of calls without taking hands from the steering wheel or using a cable to connect the compatible telephone and the system.

Refer to “Bluetooth® audio/phone,” Section 5-2 in the *Owner’s Manual*, for more information about phone connections and compatibility.

Pairing a Bluetooth Device

1. Press the “SETUP” button
(For models equipped with Entune Audio Plus, Entune Premium Audio with Navigation and App Suite or Entune Premium JBL Audio with Navigation and App Suite, press the “APPS” button followed by the “Setup” button on the display screen.)
2. Touch “Bluetooth” on the display screen
3. Touch “Add” on the display screen
4. Go to your phone and access Bluetooth settings
5. On your phone, touch the device to be paired.
6. Confirm the PIN. Touch “OK” or “Pair”

Once you have connected the Bluetooth device, it is automatically connected whenever the engine switch is in the “ACC” or “ON” position.

** For detailed pairing instructions, see your audio system owner’s manual.

Audio

Type 1

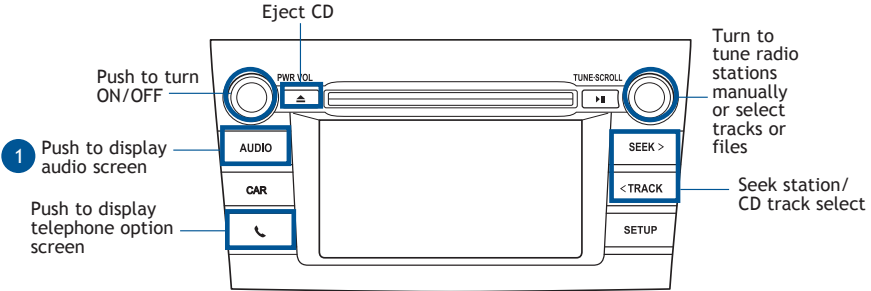

Type 2 - Entune Audio Plus (additional functions)

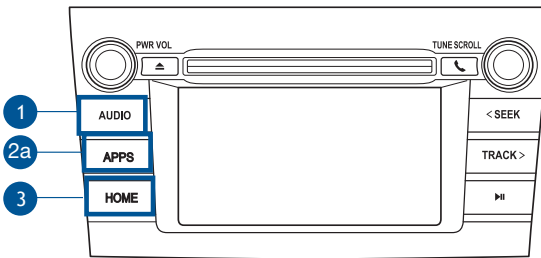

Type 3 - Entune Premium Audio with Navigation and App Suite (additional functions)

Limited models may be equipped with the JBL upgrade in this unit.

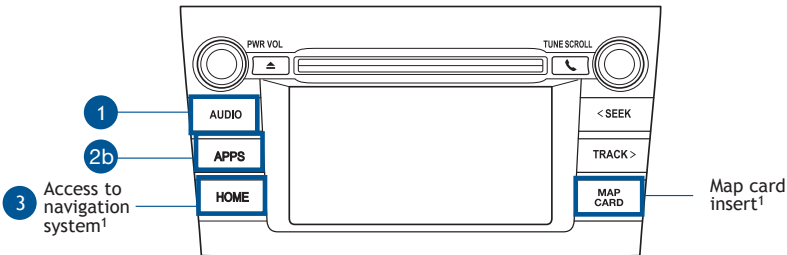

¹ Refer to the "NAVIGATION AND MULTIMEDIA SYSTEM OWNER'S MANUAL".

- 1 AUDIO Button
Access to audio functions.
- 2a APPS Button
Access to traffic and weather
- 2b APPS Button
Access to Entune® App Suite, sports, stocks, news, traffic and weather

- 3 HOME Button
Access to Home screen.

HOME SCREEN - the home screen offers a two panel and a three panel layout. Information and layout will vary depending on selected set up.

Quick Tip - The USB and AUX port location and design are different depending on the vehicle. For details, see Page 22.

iPod®/USB/AUX port

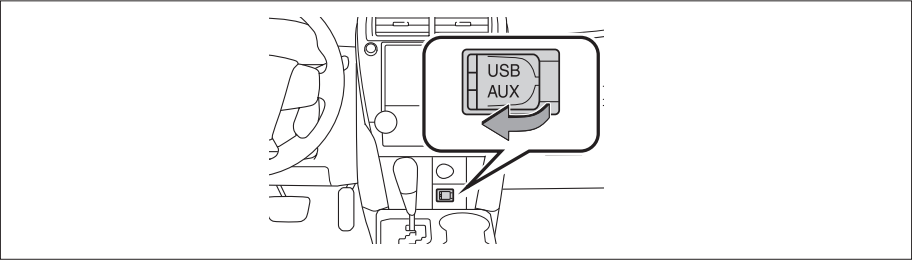



By connecting a USB-compatible portable audio device or USB memory to the USB port, you can listen to music from the portable audio device or USB memory through the vehicle's speaker system.

By inserting a mini plug into the AUX port, you can listen to music from a portable audio device through the vehicle's speaker system while in AUX mode.

Traffic (Entune Audio Plus only)



The Traffic App displays a scrollable map showing local traffic in 3 colors. Traffic conditions are displayed in red, yellow and green for heavy, moderate or light traffic conditions. Use  or  arrows to scroll the map up or down.

Weather (Entune Audio Plus only)

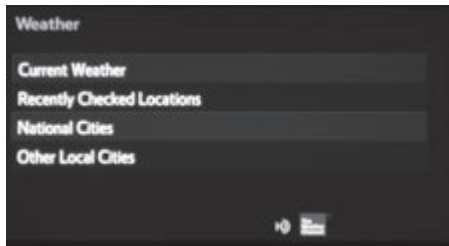

The Weather App options show current weather and recently checked locations weather. You can also search for a weather forecast by national or local cities.

Always drive safely, obey traffic laws & focus on the road while driving. Availability and accuracy of the information provided by HD services is dependent upon many factors. Services not available in every city or roadway. Use common sense when relying on information provided. HD Radio(tm) Technology manufactured under license from iBiquity Digital Corporation U.S. and Foreign Patents. HD Radio(tm) and the HD, HD Radio, and "Arc" logos are proprietary trademarks of iBiquity Digital Corp.

Cup holders

Front

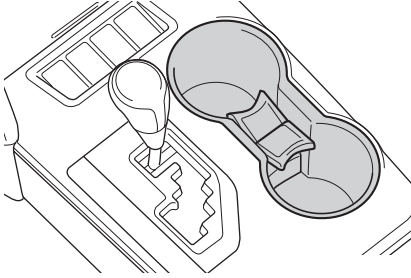

Rear



Bottle holders

Front door

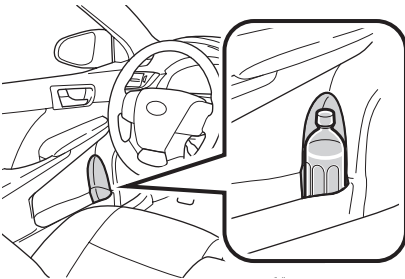

Rear door

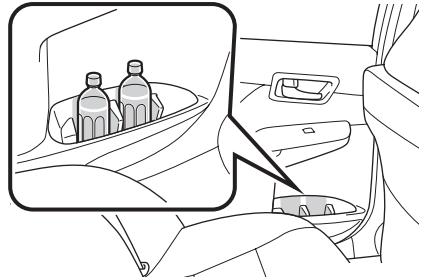

SAFETY AND EMERGENCY FEATURES

Door locks

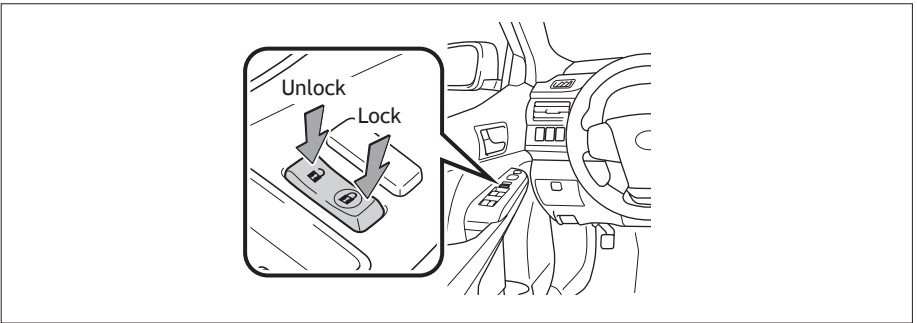

Doors-Child safety locks

Rear door

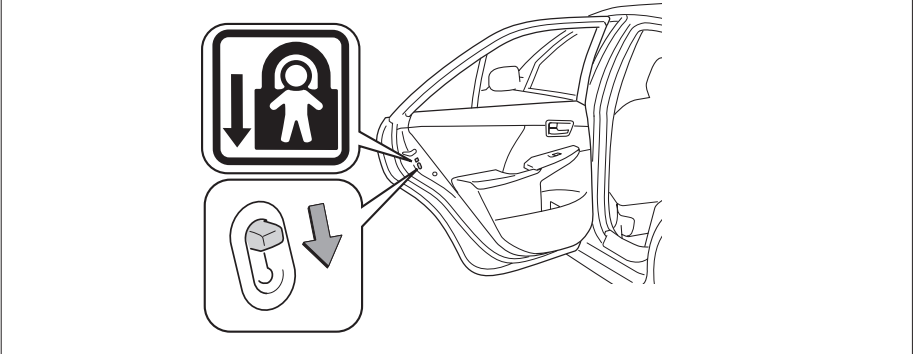

Moving the lever to downward will allow the door to be opened only from the outside.

Seat belts

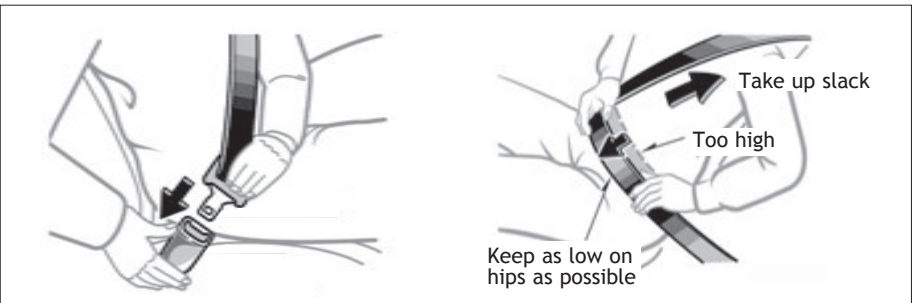

If belt is fully extended, then retracted even slightly, it cannot be re-extended beyond that point, unless fully retracted again. This feature is used to help hold child restraint systems securely.

To find more information about seat belts, and how to install a child restraint system, refer to the *Owner's Manual*.

Seat belts-Shoulder belt anchor

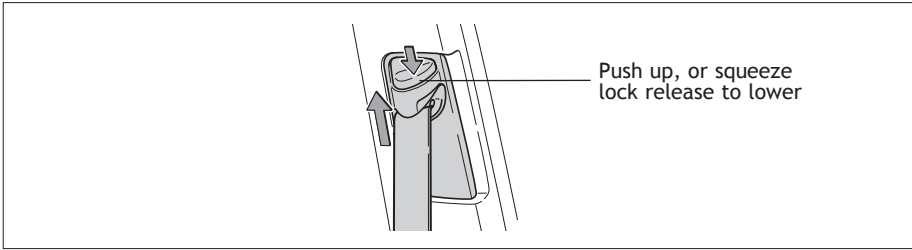

Safety Connect

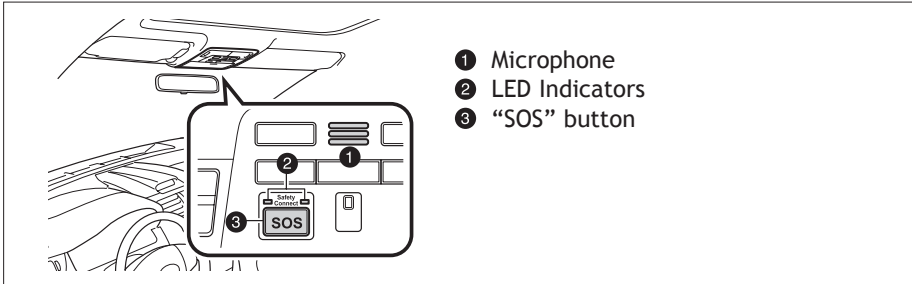

Safety Connect is a subscription-based telematics service that uses Global Positioning System (GPS) data and embedded cellular technology to provide safety and security features to subscribers. Safety Connect is supported by Toyota's designated response center, which operates 24 hours per day, 7 days per week. Services for subscribers include: Automatic collision notification, Stolen vehicle location, Emergency assistance button and Enhanced roadside assistance

Contact your dealer for more information about Safety Connect.

Spare tire & tools

Tool location

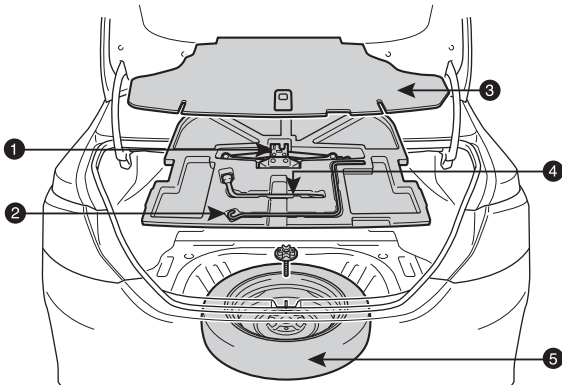

- ① Jack
- ② Jack handle
- ③ Luggage floor cover
- ④ Wheel nut wrench
- ⑤ Spare tire

Removing the spare tire

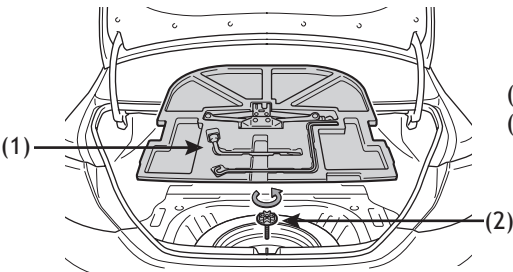

- (1) Remove the tool tray.
- (2) Loosen the center fastener that secures the spare tire.

Refer to the *Owner's Manual* for tire changing and jack positioning procedures.

Trunk-Internal release

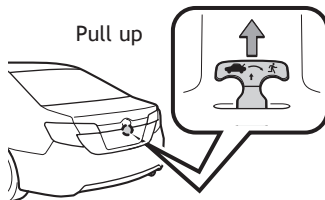

Star Safety System™

All new Toyota vehicles come standard with the Star Safety System™, which combines Vehicle Stability Control (VSC), Traction Control (TRAC), Anti-lock Braking System (ABS), Electronic Brake-force Distribution (EBD), Brake Assist (BA) and Smart Stop Technology (SST).

Vehicle Stability Control (VSC)

VSC helps prevent loss of traction during cornering by reducing engine power and applying brake force to selected wheels.

Toyota's VSC monitors steering angle and the direction your vehicle is traveling. When it senses that the front or rear wheels begin to lose traction, VSC reduces engine power and applies braking to selected wheels. This helps restore traction and vehicle control.

Traction Control (TRAC)

VSC helps prevent loss of traction during cornering by reducing engine power, and Traction Control helps maintain traction on loose gravel and wet, icy, or uneven surfaces by applying brake force to the spinning wheel(s).

Toyota's TRAC sensors are activated when one of the drive wheels starts to slip. TRAC limits engine output and applies the brakes to the spinning wheel. This transfers power to the wheels that still have traction to help keep you on track.

Anti-Lock Brake System (ABS)

ABS helps prevent brakes from locking up by "pulsing" brake pressure to each wheel. This limits brake lockup and helps provide directional control for the current road conditions.

Toyota's ABS sensors detect which wheels are locking up and limits wheel lockup by "pulsing" each wheel's brakes independently. Pulsing releases brake pressure repeatedly for fractions of a second. This helps the tires attain the traction that current road conditions will allow, helping you to stay in directional control.

Electronic Brake Force Distribution (EBD)

Toyota's ABS technology has Electronic Brake-force Distribution (EBD) to help maintain control and balance when braking. Abrupt stops can cause a vehicle to tilt forward, reducing the braking power of the rear wheels. EBD responds to sudden stops by redistributing brake force to enhance the braking effectiveness of all four wheels.

Brake Assist (BA)

Brake Assist is designed to detect sudden or "panic" braking, and then add braking pressure to help decrease the vehicle's stopping distance. When there's only a split second to react, Brake Assist can add additional brake pressure more quickly than just the driver alone can.

Smart Stop Technology (SST)

Smart Stop Technology automatically reduces driving torque when the accelerator and brake pedals are pressed simultaneously under certain conditions.

SST engages when the accelerator is depressed first and the brakes are applied firmly for longer than one-half second at speeds greater than five miles per hour.

SST doesn't engage if the brake pedal is depressed before the accelerator pedal, allowing vehicles to start on a steep hill and safely accelerate without rolling backward.

Floor mat installation

There are two types of Toyota floor mats: carpeted and all-weather. Each vehicle has model-specific floor mats. Installation is easy.

To keep your floor mat properly positioned, follow these steps:

- Only use floor mats designed for your specific model.
- Use only one floor mat at a time, using the retaining hooks to keep the mat in place.
- Install floor mats right side up.

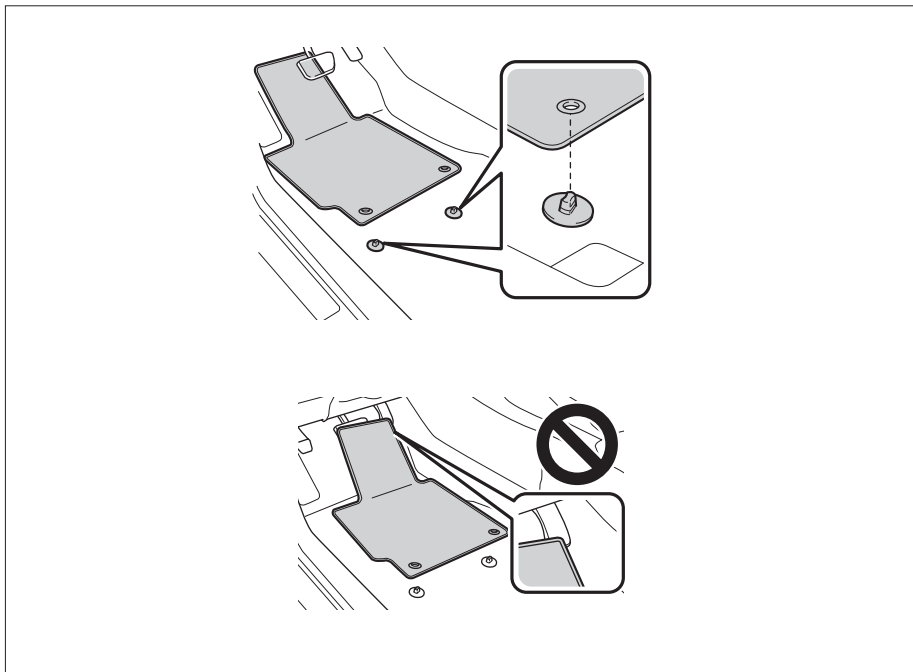



CUSTOMER EXPERIENCE CENTER

1-800-331-4331

