

	Pictorial index	Search by illustration
1	For safety and security	Make sure to read through them
2	Instrument cluster	How to read the gauges and meters, the variety of warning lights and indicators, etc.
3	Operation of each component	Opening and closing the doors and windows, adjustment before driving, etc.
4	Driving	Operations and advice which are necessary for driving
5	Audio system	Operating the audio system
6	Interior features	Usage of the interior features, etc.
7	Maintenance and care	Caring for your vehicle and maintenance procedures
8	When trouble arises	What to do in case of malfunction or emergency
9	Vehicle specifications	Vehicle specifications, etc.
	Index	Search by symptom
		Search alphabetically

For your information	8
Reading this manual.....	14
How to search	15
Pictorial index	16

1 For safety and security

1-1. For safe use	
Before driving.....	36
For safety drive	38
Seat belts	40
SRS airbags.....	45
Exhaust gas precautions	56
1-2. Child safety	
Front passenger occupant classification system	57
Airbag manual on-off system	62
Riding with children.....	64
Child restraint systems	65
1-3. Theft deterrent system	
Engine immobilizer system	107
Alarm	116

2 Instrument cluster

2. Instrument cluster	
Warning lights and indicators.....	120
Gauges and meters.....	128
Multi-information display (Type A)	133
Multi-information display (Type B)	136
Fuel consumption information	144

3 Operation of each component

3-1. Key information	
Keys	148
3-2. Opening, closing and locking the doors	
Side doors	160
Access panels (smart-cab models only).....	166
Tailgate	167
Smart entry & start system.....	170
3-3. Adjusting the seats	
Front seats	186
Rear seats	188
Head restraints	191
3-4. Adjusting the steering wheel and mirrors	
Steering wheel	194
Inside rear view mirror.....	196
Outside rear view mirrors	197

3-5. Opening and closing the windows	
Power windows	200
Quarter windows (smart-cab models).....	204
Back window (sliding type)	205

4 Driving

4-1. Before driving	
Driving the vehicle	208
Cargo and luggage	221
Trailer towing (except models for model code destination W).....	222
Trailer towing (models for model code destination W)	223
4-2. Driving procedures	
Engine (ignition) switch (vehicles without smart entry & start system).....	236
Engine (ignition) switch (vehicles with smart entry & start system).....	239
Automatic transmission.....	247
Manual transmission.....	254
Turn signal lever	260
Parking brake.....	261
4-3. Operating the lights and wipers	
Headlight switch.....	262
Fog light switch	269
Windshield wipers and washer	271

4-4. Refueling	
Opening the fuel tank cap	274
4-5. Using the driving support systems	
Toyota Safety Sense	279
PCS (Pre-Crash Safety system)	287
LDA (Lane Departure Alert)	300
RSA (Road Sign Assist)	309
Cruise control	314
Rear view monitor system.....	318
Four-wheel drive system.....	329
Rear differential lock system	339
Stop & Start system (Smart Stop).....	343
Driving assist systems.....	353
Downhill assist control system.....	361
DPF (Diesel Particulate Filter) system	364
4-6. Driving tips	
Winter driving tips.....	368

5 Audio system

5-1. Basic Operations	
Audio system types	374
Steering wheel audio switches	376
AUX port/USB port	379
5-2. Using the audio system	
Optimal use of the audio system.....	380

5-3. Using the radio	
Radio operation	382
5-4. Playing an audio CD and MP3/WMA discs	
CD player operation	387
5-5. Using an external device	
Listening to an iPod	397
Listening USB memory device	405
Using the AUX port	412
5-6. Using Bluetooth® devices	
Bluetooth® audio/phone.....	413
Using the steering wheel switches	418
Registering a Bluetooth® device	419
5-7. “SETUP” menu	
Using the “SETUP” menu (“Bluetooth*” menu).....	420
Using the “SETUP” menu (“TEL” or “PHONE” menu)	426
5-8. Bluetooth® Audio	
Operating a Bluetooth® enabled portable player	433
5-9. Bluetooth® Phone	
Making a phone call	435
Receiving a phone call.....	437
Speaking on the phone.....	438
5-10. Bluetooth®	
Bluetooth®	440

6 Interior features

6-1. Using the air conditioning system and defogger	
Manual air conditioning system.....	448
Automatic air conditioning system.....	456
Seat heaters.....	465
6-2. Using the interior lights	
Interior lights list	466
• Personal/interior light main switch	467
• Personal/interior lights	467
• Interior light	467
6-3. Using the storage features	
List of storage features.....	469
• Glove box.....	470
• Console box	470
• Cup holders	471
• Bottle holders	472
• Auxiliary boxes.....	473
Luggage compartment features	476
6-4. Using the other interior features	
Other interior features	477
• Sun visors	477
• Vanity mirror	477
• Clock	478
• Power outlets	479
• Grocery bag hooks	481
• Coat hooks.....	482
• Armrest	482
ERA-GLONASS	483

*: The Bluetooth® word mark and logos are registered trademarks owned by Bluetooth SIG, Inc.

7 Maintenance and care

7-1. Maintenance and care

- Cleaning and protecting the vehicle exterior486
- Cleaning and protecting the vehicle interior489

7-2. Maintenance

- Maintenance requirements492

7-3. Do-it-yourself maintenance

- Do-it-yourself service precautions495
- Hood497
- Engine compartment499
- Tires518
- Tire inflation pressure526
- Wheels528
- Air conditioning filter530
- Wireless remote control/electronic key battery532
- Checking and replacing fuses535
- Light bulbs540

8 When trouble arises

8-1. Essential information

- Emergency flashers556
- If your vehicle has to be stopped in an emergency557

8-2. Steps to take in an emergency

- If your vehicle needs to be towed 559
- If you think something is wrong 564
- Fuel pump shut off system (gasoline engine only) 565
- Fire extinguisher 566
- If a warning light turns on or a warning buzzer sounds 567
- If a warning message is displayed 577
- If you have a flat tire 584
- If the engine will not start 601
- If the electronic key does not operate properly (vehicles with smart entry & start system) 603
- If the vehicle battery is discharged 607
- If your vehicle overheats 613
- If you run out of fuel and the engine stalls (diesel engine only) 616
- If the vehicle becomes stuck 617

9 Vehicle specifications

9-1. Specifications

Maintenance data (fuel, oil level, etc.).....	620
Fuel information	645

9-2. Customization

Customizable features	648
-----------------------------	-----

9-3. Initialization

Items to initialize	655
---------------------------	-----

Index

What to do if... (Troubleshooting).....	658
Alphabetical index	662

تلفن شبانه روزی: ۰۲۱-۸۸۸۶۲۰۸۵

FarmaSOS.com

For vehicles with navigation system or multimedia system, refer to the “Navigation and multimedia system Owner’s manual” for information regarding the equipment listed below.

- Navigation system
- Audio system
- Hands-free system (for cellular phone)

Toyota Motor Europe NV/SA, Avenue du Bourget 60 - 1140
Brussels, Belgium www.toyota-europe.com

امداد خودرو فارما

تلفن شبانه روزی: ۰۲۱-۸۸۸۶۲۰۸۵

FarmaSOS.com

1

2

3

4

5

6

7

8

9

For your information

Main Owner's Manual

Please note that this manual applies to all models and all equipment, including options. Therefore, you may find some explanations for equipment not installed on your vehicle.

All specifications provided in this manual are current at the time of printing. However, because of the Toyota policy of continual product improvement, we reserve the right to make changes at any time without notice.

Depending on specifications, the vehicle shown in the illustrations may differ from your vehicle in terms of equipment.

Accessories, spare parts and modification of your Toyota

Both genuine Toyota and a wide variety of other spare parts and accessories for Toyota vehicles are currently available on the market. Should it be determined that any of the genuine Toyota parts or accessories supplied with the vehicle need to be replaced, Toyota recommends that genuine Toyota parts or accessories, be used to replace them. Other parts or accessories of matching quality can also be used. Toyota cannot accept any liability or guarantee spare parts and accessories which are not genuine Toyota products, nor for replacement or installation involving such parts. In addition, damage or performance problems resulting from the use of non-genuine Toyota spare parts or accessories may not be covered under warranty.

Installation of an RF-transmitter system

The installation of an RF-transmitter system in your vehicle could affect electronic systems such as:

- Multiport fuel injection system/sequential multiport fuel injection system
- Cruise control system
- Anti-lock brake system
- SRS airbag system
- Seat belt pretensioner system

Be sure to check with any authorized Toyota dealer or repairer, or another duly qualified and equipped professional for precautionary measures or special instructions regarding installation of an RF-transmitter system.

Further information regarding frequency bands, power levels, antenna positions and installation provisions for the installation of RF-transmitters, is available on request at any authorized Toyota dealer or repairer, or another duly qualified and equipped professional.

Scrapping of your Toyota

The SRS airbag and seat belt pretensioner devices in your Toyota contain explosive chemicals. If the vehicle is scrapped with the airbags and seat belt pretensioners left as they are, this may cause an accident such as fire. Be sure to have the systems of the SRS airbag and seat belt pretensioner removed and disposed of by a qualified service shop or by any authorized Toyota dealer or repairer, or another duly qualified and equipped professional before you scrap your vehicle.



Your vehicle contains batteries and/or accumulators. Do not discard them into the environment but cooperate with separate collection (Directive 2006/66/EC).

تلفن شبانه روزی: ۰۲۱-۸۸۸۶۲۰۸۵

FarmaSOS.com

 **WARNING****■ General precautions while driving**

Driving under the influence: Never drive your vehicle when under the influence of alcohol or drugs that have impaired your ability to operate your vehicle. Alcohol and certain drugs delay reaction time, impair judgment and reduce coordination, which could lead to an accident that could result in death or serious injury.

Defensive driving: Always drive defensively. Anticipate mistakes that other drivers or pedestrians might make and be ready to avoid accidents.

Driver distraction: Always give your full attention to driving. Anything that distracts the driver, such as adjusting controls, talking on a cellular phone or reading can result in a collision with resulting death or serious injury to you, your occupants or others.

■ General precaution regarding children's safety

Never leave children unattended in the vehicle, and never allow children to have or use the key.

Children may be able to start the vehicle or shift the vehicle into neutral. There is also a danger that children may injure themselves by playing with the windows or other features of the vehicle. In addition, heat build-up or extremely cold temperatures inside the vehicle can be fatal to children.

تلفن شبانه روزی: ۰۲۱-۸۸۸۶۲۰۸۵

FarmaSOS.com

Checking your vehicle's model

Check the model code to see what type of model your vehicle is.

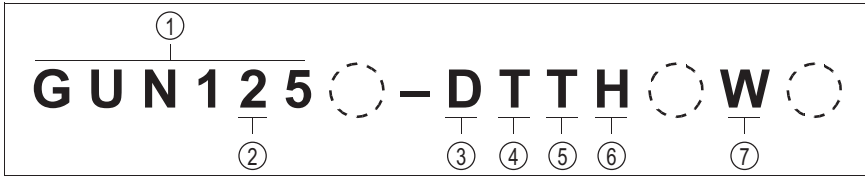

① Basic code

TGN1*6: Models with 2TR-FE engine

GUN1*6: Models with 1GD-FTV engine

GUN1*5: Models with 2GD-FTV engine

KUN1*5: Models with 2KD-FTV engine

② Driving system

2: 4WD models

3: Pre Runner (2WD models)

③ Cab type

B: Single-cab

C: Smart-cab

D: Double-cab

④ Made in

N: South Africa

T: Thailand

تلفن شبانه روزی: ۰۲۱-۸۸۸۶۲۰۸۵

FarmaSOS.com

⑤ Transmission type

T: Automatic transmission

M: 5-speed manual transmission

F: 6-speed manual transmission

⑥ Grade

H: HIGH

M: MID

S: STD

L: LOW

X: LOWEST

⑦ Destination

W: Models for European countries etc.

V: Models for Caucasus area etc.

Blank: Models for Kazakhstan etc.

The model code appears on the manufacturer's label or plate with the heading "MODEL".

امداد خودرو فارما

تلفن شبانه روزی: ۰۲۱-۸۸۸۶۲۰۸۵

FarmaSOS.com

The label or plate is placed as shown in the following illustrations.

► Type A

The manufacturer's label is located on the left pillar.

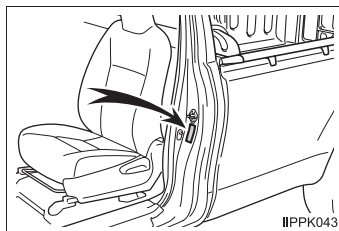

► Type B

The manufacturer's label is located on the left pillar.

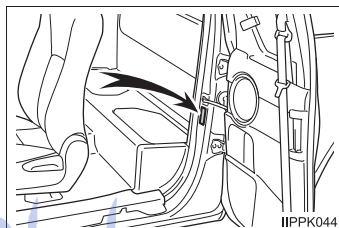

► Type C

The manufacturer's label is located on the left pillar.

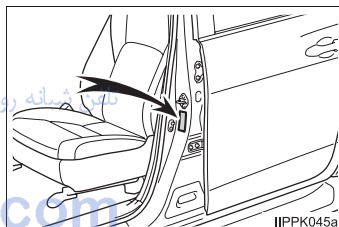

► Type D

The manufacturer's plate is located beside the engine compartment.

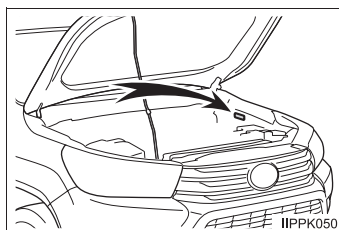

Reading this manual



WARNING:

Explains something that, if not obeyed, could cause death or serious injury to people.



NOTICE:

Explains something that, if not obeyed, could cause damage to or a malfunction in the vehicle or its equipment.



1 2 3... Indicates operating or working procedures. Follow the steps in numerical order.



Indicates the action (pushing, turning, etc.) used to operate switches and other devices.



Indicates the outcome of an operation (e.g. a lid opens).

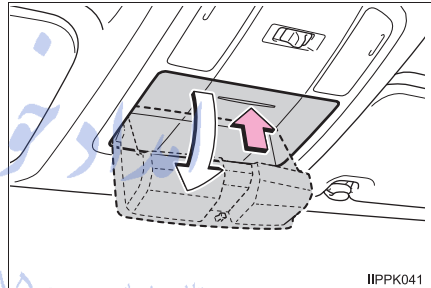

Indicates the component or position being explained.



Means “Do not”, “Do not do this”, or “Do not let this happen”.

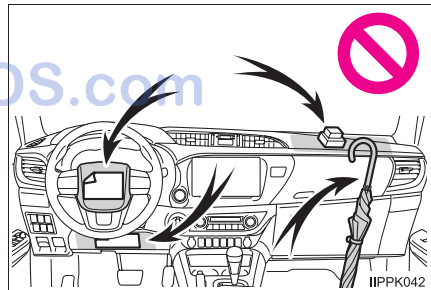

How to search

■ Searching by name

- Alphabetical index P. 662

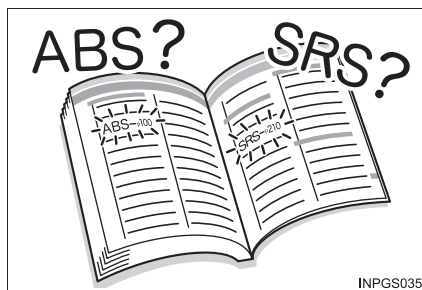

■ Searching by installation position

- Pictorial index P. 16



■ Searching by symptom or sound

- What to do if...
(Troubleshooting) P. 658

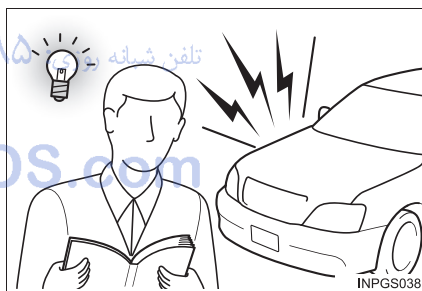

■ Searching by title

- Table of contents P. 2

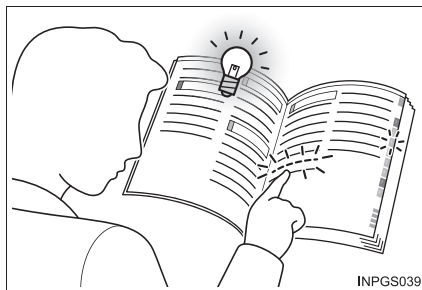

Pictorial index

Exterior

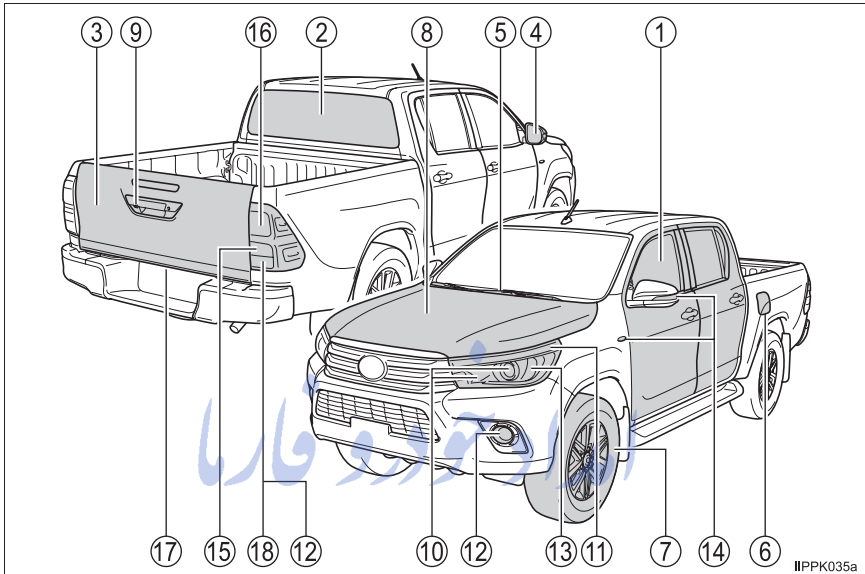

The shape of the headlights may differ depending on the grade, etc. (→P. 540)

- | | | |
|---|---|---------------|
| ① | Side doors | P. 160 |
| | Access panels (smart-cab models only) | P. 166 |
| | Locking/unlocking | P. 160 |
| | Opening/closing the door glasses | P. 200 |
| | Locking/unlocking by using the mechanical key*1 | P. 603 |
| | Warning lights*1/warning messages*1 | P. 162, 571 |
| ② | Back window (sliding type) | P. 205 |
| ③ | Tailgate *1 | P. 167 |
| ④ | Outside rear view mirrors | P. 197 |
| | Adjusting the mirror angle | P. 197 |
| | Folding the mirrors | P. 198 |
| | Defogging the mirrors*1 | P. 449, 458 |

⑤	Windshield wipers	P. 271
	Precautions against winter season	P. 368
⑥	Fuel filler door*¹	P. 274
	Refueling method	P. 274
	Fuel type/fuel tank capacity	P. 627
⑦	Tires	P. 518
	Tire size/inflation pressure	P. 642
	Winter tires/tire chain	P. 368
	Checking/rotation/tire pressure warning system* ¹	P. 519
	Coping with flat tires	P. 584
⑧	Hood	P. 497
	Opening	P. 497
	Engine oil	P. 628
	Coping with overheat	P. 613
⑨	Camera*¹	P. 318

Light bulbs of the exterior lights for driving

(Replacing method: P. 540, Watts: P. 644)

⑩	Headlights	P. 262
⑪	Front position lights/daytime running lights*¹	P. 262
⑫	Front fog lights*¹/rear fog light*^{1, 2}	P. 269
⑬	Front turn signal lights	P. 260
⑭	Side turn signal lights (fender-mounted type or mirror-mounted type)	P. 260
⑮	Rear turn signal lights	P. 260
⑯	Stop/tail lights	P. 262
	Downhill assist control system* ¹	P. 361
⑰	License plate light	P. 262
⑱	Back-up lights*²	
	Shifting the shift lever to R.	P. 247, 254

*¹: If equipped

*²: They may be located on the opposite side depending on the target region.

Instrument panel (Left-hand drive vehicles)

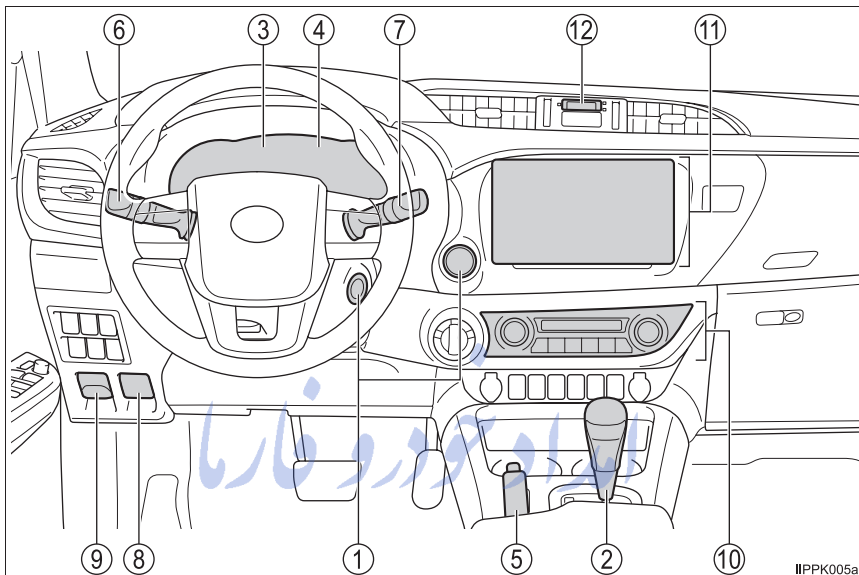

- ① **Engine switch** P. 236, 239
 Starting the engine/changing the positions or modes ... P. 236, 239
 Emergency stop of the engine P. 557
 When the engine will not start P. 601
 Warning messages*1 P. 577
- ② **Shift lever (Automatic transmission)** P. 247
 Changing the shift position P. 247
 Precautions against towing P. 559
 When the shift lever does not move P. 252
Shift lever (Manual transmission) P. 254
 Changing the shift position P. 254
 Precautions against towing P. 559

IIPPK005a

③	Meters	P. 128
	Reading the meters	P. 128
	Adjusting the instrument panel light* ¹	P. 128
	Warning lights/indicator lights	P. 120
	When the warning lights come on	P. 567
④	Multi-information display * ¹	P. 133, 136
	When the warning messages are displayed	P. 577
⑤	Parking brake lever	P. 261
	Applying/releasing	P. 261
	Precautions against winter season	P. 369
	Warning light/buzzer	P. 567
⑥	Turn signal lever	P. 260
	Headlight switch	P. 262
	Headlights/front position lights/tail lights/daytime running lights* ¹	P. 262
	Front fog lights* ¹ /rear fog light* ¹	P. 269
⑦	Windshield wiper and washer switch	P. 271
	Usage	P. 271
	Adding washer fluid	P. 511
	Warning messages* ¹	P. 577
⑧	Hood lock release lever	P. 497
⑨	Fuel filler door opener * ¹	P. 276
⑩	Manual air conditioning system * ¹	P. 448
	Automatic air conditioning system * ¹	P. 456
⑪	Audio system * ¹	P. 374
	AUX port/USB port	P. 379
	Navigation system/Multimedia system * ^{1, 2} Rear view monitor system * ¹	P. 318
⑫	Clock	P. 478

*¹: If equipped*²: Refer to "Navigation and multimedia system Owner's manual".

Switches (Left-hand drive vehicles)

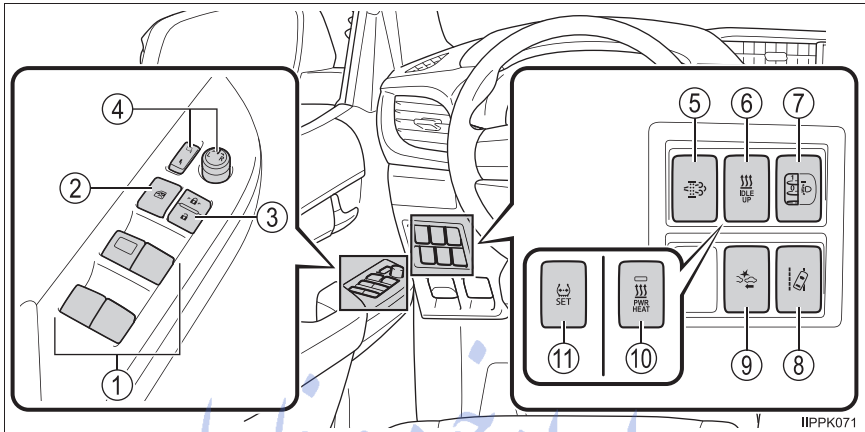

- | | | |
|--|-------|-------------|
| ① Power window switches*1 | | P. 200 |
| ② Window lock switch*1 | | P. 201 |
| ③ Door lock switch*1 | | P. 162 |
| ④ Outside rear view mirror switches*1 | | P. 197 |
| ⑤ DPF system switch*1 | | P. 364 |
| ⑥ Heater idle up switch*1 | | P. 450 |
| ⑦ Manual headlight leveling dial*1 | | P. 264 |
| ⑧ LDA (Lane Departure Alert) switch*1 | | P. 300 |
| ⑨ PCS (Pre-Crash Safety system) switch*1 | | P. 287 |
| ⑩ Power heater switch*1 | | P. 450, 459 |
| ⑪ Tire pressure warning reset switch*1 | | P. 520 |

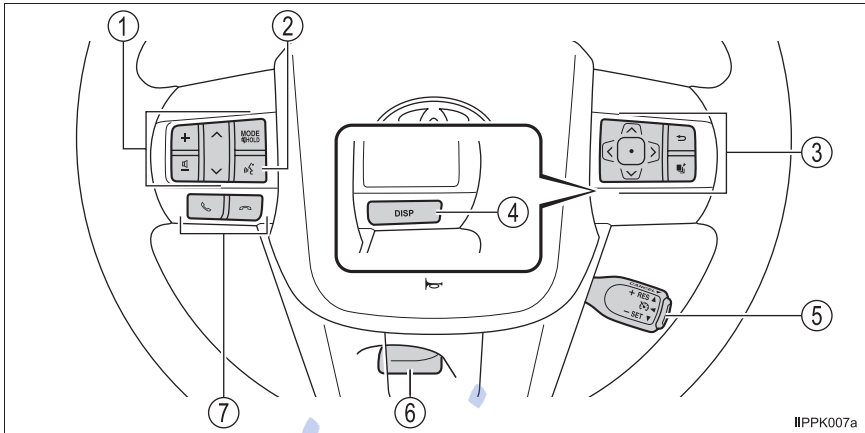

IIPPK007a

- ① Audio remote control switches*1, 2 P. 376
- ② Talk switch*1, 2, 3 P. 376
- ③ Meter control switches*1 P. 137
- ④ “DISP” button*1 P. 134
- ⑤ Cruise control switch*1 P. 314
- ⑥ Tilt steering lock release lever P. 194
- ⑦ Telephone switches*1, 2 P. 418

FarmaSOS.com

*1: If equipped

*2: Refer to “Navigation and multimedia system Owner’s manual”.

*3: The switch can not be used depending on the type of audio system or navigation system.

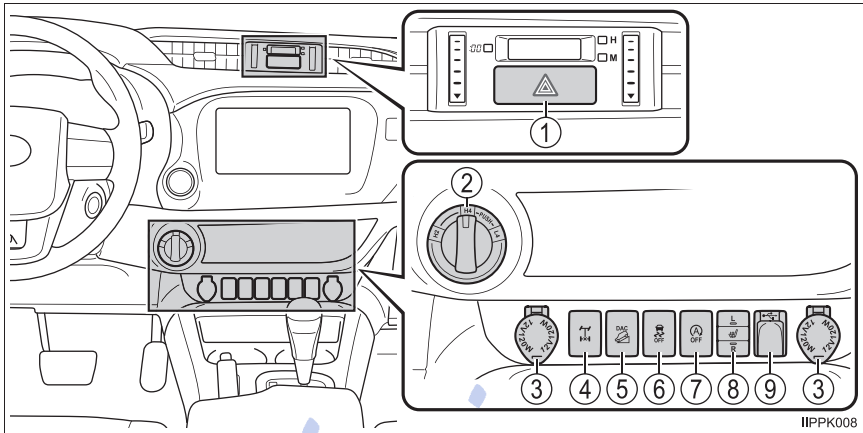

IIPK008

- ① **Emergency flasher switch** P. 556
- ② **Front-wheel drive control switch*1** P. 329
- ③ **Power outlets*1** P. 479
- ④ **Rear differential lock switch*1** P. 339
- ⑤ **“DAC” (Downhill Assist Control system) switch*1** P. 361
- ⑥ **VSC OFF switch*1** P. 355
- ⑦ **Stop & Start cancel switch*1** P. 344
- ⑧ **Seat heater switches*1** P. 465
- ⑨ **AUX port/USB port*1, 2**

Interior (Left-hand drive vehicles)

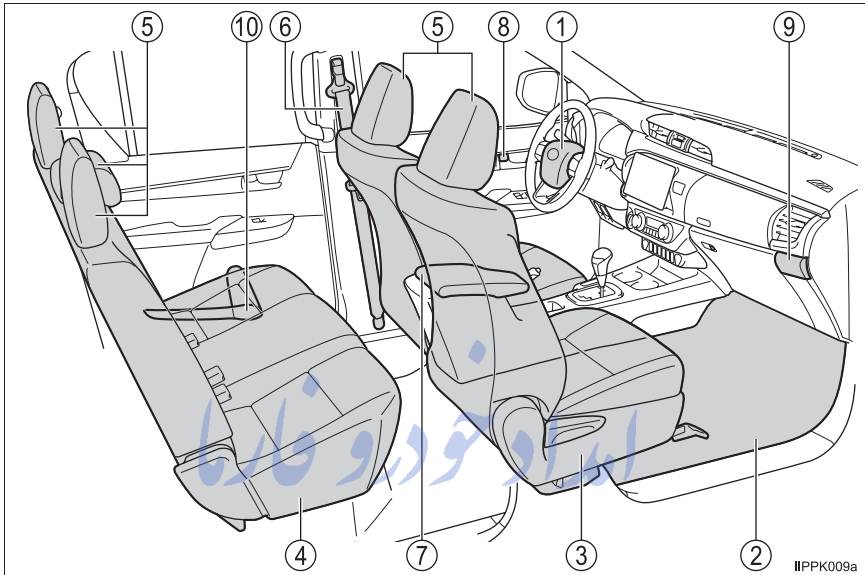

- | | | |
|-----------------------|-------|--------|
| ① SRS airbags*1 | | P. 45 |
| ② Floor mats | | P. 36 |
| ③ Front seats | | P. 186 |
| ④ Rear seats*1 | | P. 188 |
| ⑤ Head restraints | | P. 191 |
| ⑥ Seat belts | | P. 40 |
| ⑦ Console box*1 | | P. 470 |
| ⑧ Inside lock buttons | | P. 162 |
| ⑨ Cup holders | | P. 471 |
| Auxiliary boxes | | P. 473 |
| ⑩ Bottle holders*1 | | P. 472 |

*1: If equipped

*2: Refer to "Navigation and multimedia system Owner's manual".

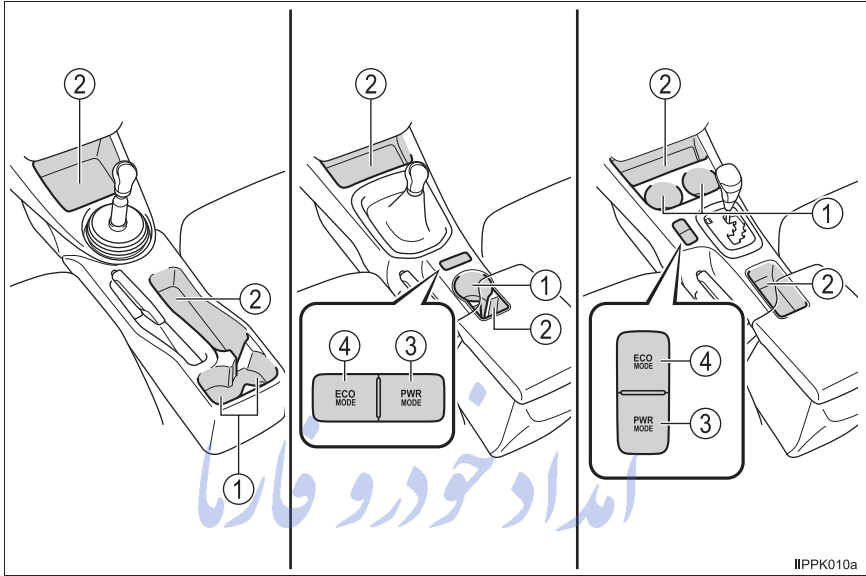

IIPPK010a

- ① Cup holders*1 P. 471
- ② Auxiliary boxes*1 P. 473
- ③ "PWR MODE" switch*1 P. 249, 255
- ④ "ECO MODE" switch*1 P. 249, 255

FarmaSOS.com

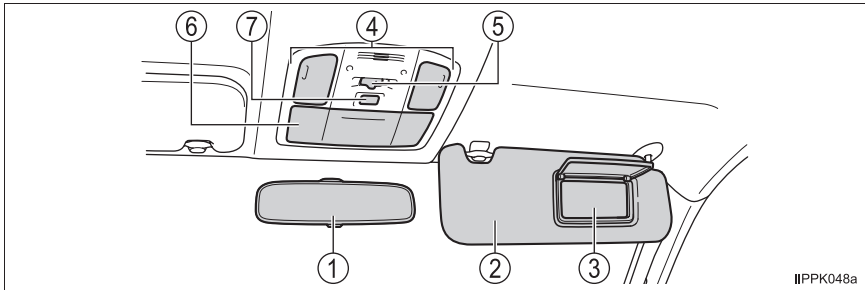

- ① Inside rear view mirror P. 196
- ② Sun visors*² P. 477
- ③ Vanity mirror*¹ P. 477
- ④ Personal lights P. 467
Interior lights*^{1, 3} P. 467
- ⑤ Personal/interior light main switch P. 467
- ⑥ Auxiliary boxes P. 473
- ⑦ "SOS" button*^{1, 4} P. 483

تلفن شبانه روزی: ۰۲۱-۸۸۸۶۲۰۸۵

FarmaSOS.com

*1: If equipped

*2: NEVER use a rearward facing child restraint on a seat protected by an ACTIVE AIRBAG in front of it, DEATH or SERIOUS INJURY to the CHILD can occur. (→P. 71)



*1

*3: The illustration shows the front, but they are also equipped in the rear.

*4: The button can not be used in vehicles without ERA-GLONASS.

Instrument panel (Right-hand drive vehicles)

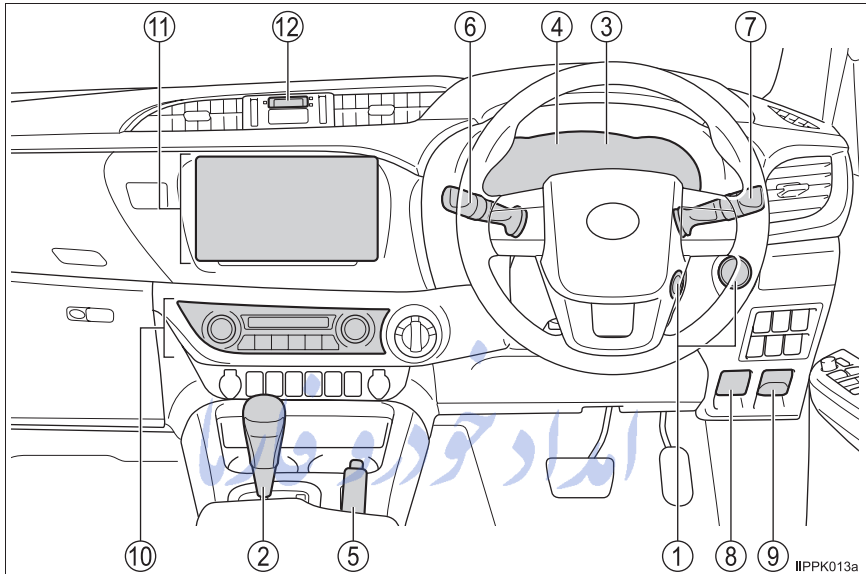

- ① **Engine switch** P. 236, 239
 Starting the engine/changing the positions or modes ... P. 236, 239
 Emergency stop of the engine P. 557
 When the engine will not start P. 601
 Warning messages P. 577
- ② **Shift lever (Automatic transmission)** P. 247
 Changing the shift position P. 247
 Precautions against towing P. 559
 When the shift lever does not move P. 252
Shift lever (Manual transmission) P. 254
 Changing the shift position P. 254
 Precautions against towing P. 559

③	Meters	P. 128
	Reading the meters	P. 128
	Adjusting the instrument panel light	P. 128
	Warning lights/indicator lights	P. 120
	When the warning lights come on	P. 567
④	Multi-information display	P. 133, 136
	When the warning messages are displayed	P. 577
⑤	Parking brake lever	P. 261
	Applying/releasing	P. 261
	Precautions against winter season	P. 369
	Warning light/buzzer	P. 567
⑥	Turn signal lever	P. 260
	Headlight switch	P. 262
	Headlights/front position lights/tail lights/daytime running lights*1	P. 262
	Front fog lights*1/rear fog light*1	P. 269
⑦	Windshield wiper and washer switch	P. 271
	Usage	P. 271
	Adding washer fluid	P. 511
	Warning messages*1	P. 577
⑧	Hood lock release lever	P. 497
⑨	Fuel filler door opener *1	P. 276
⑩	Manual air conditioning system *1	P. 448
	Automatic air conditioning system *1	P. 456
⑪	Audio system *1	P. 374
	AUX port/USB port	P. 379
	Navigation system/Multimedia system *1, 2	
	Rear view monitor system *1	P. 318
⑫	Clock	P. 478

*1: If equipped

*2: Refer to "Navigation and multimedia system Owner's manual".

Switches (Right-hand drive vehicles)

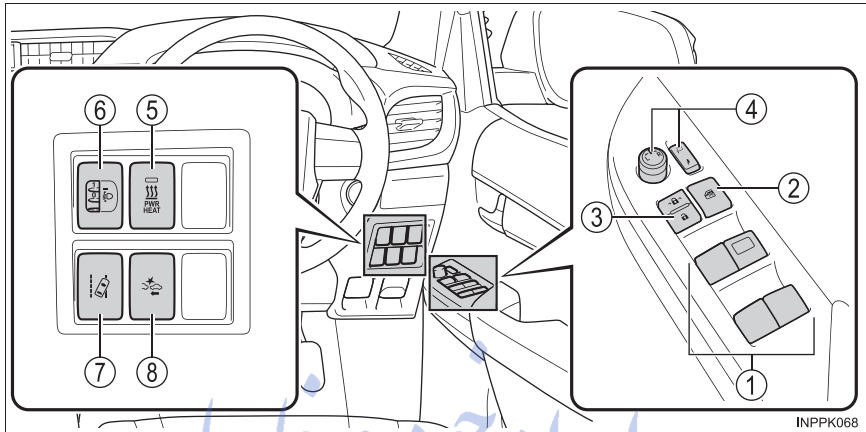

- | | | |
|---|--|-------------|
| ① | Power window switches | P. 200 |
| ② | Window lock switch | P. 201 |
| ③ | Door lock switch | P. 162 |
| ④ | Outside rear view mirror switches*1 | P. 197 |
| ⑤ | Power heater switch*1 | P. 450, 459 |
| ⑥ | Manual headlight leveling dial*1 | P. 264 |
| ⑦ | LDA (Lane Departure Alert) switch*1 | P. 300 |
| ⑧ | PCS (Pre-Crash Safety system) switch*1 | P. 287 |

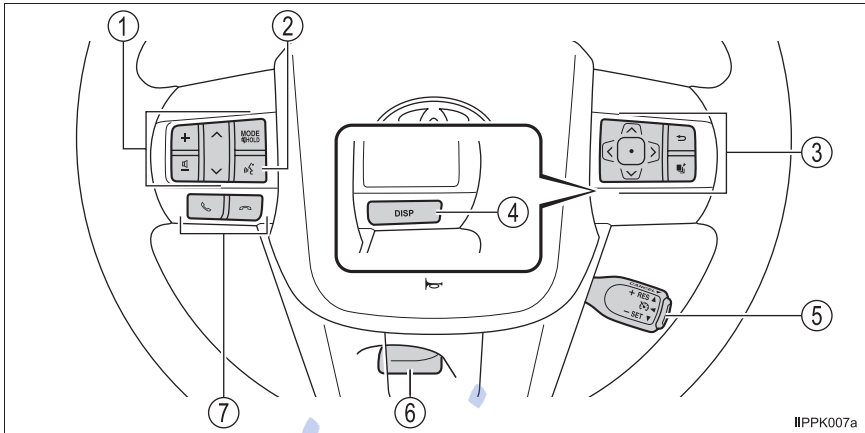

IIPPK007a

- ① Audio remote control switches*1, 2 P. 376
- ② Talk switch*1, 2, 3 P. 376
- ③ Meter control switches*1 P. 137
- ④ “DISP” button*1 P. 134
- ⑤ Cruise control switch*1 P. 314
- ⑥ Tilt steering lock release lever P. 194
- ⑦ Telephone switches*1, 2 P. 418

FarmaSOS.com

*1: If equipped

*2: Refer to “Navigation and multimedia system Owner’s manual”.

*3: The switch can not be used depending on the type of audio system or navigation system.

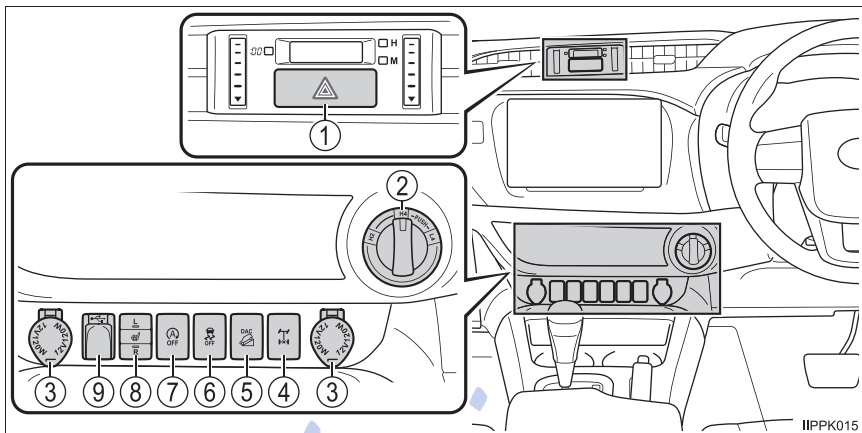

IIPPK015

- ① **Emergency flasher switch** P. 556
- ② **Front-wheel drive control switch*¹** P. 329
- ③ **Power outlets*¹** P. 479
- ④ **Rear differential lock switch*¹** P. 339
- ⑤ **“DAC” (Downhill Assist Control system) switch*¹** P. 361
- ⑥ **VSC OFF switch*¹** P. 355
- ⑦ **Stop & Start cancel switch*¹** P. 344
- ⑧ **Seat heater switches*¹** P. 465
- ⑨ **AUX port/USB port*^{1, 2}**

Interior (Right-hand drive vehicles)

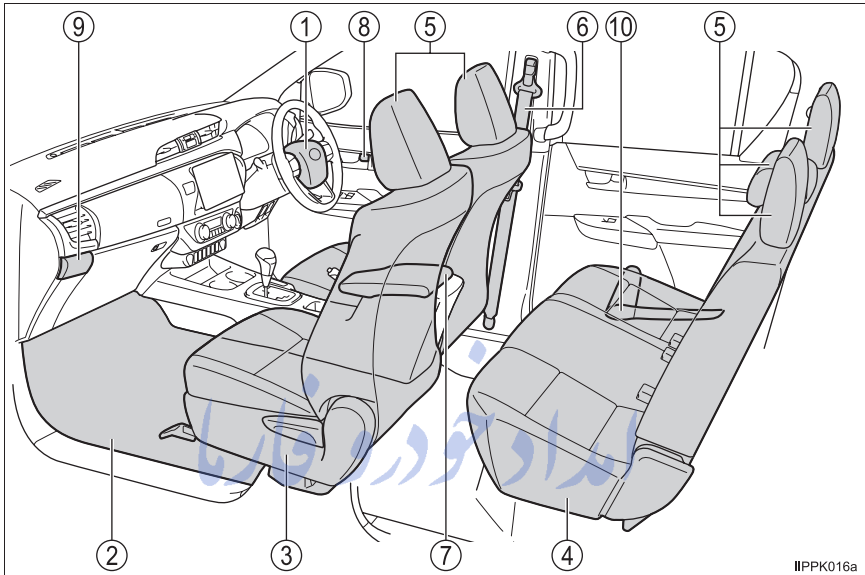

- | | | |
|---|---------------------|--------------|
| ① | SRS airbags | P. 45 |
| ② | Floor mats | P. 36 |
| ③ | Front seats | P. 186 |
| ④ | Rear seats*1 | P. 188 |
| ⑤ | Head restraints | P. 191 |
| ⑥ | Seat belts | P. 40 |
| ⑦ | Console box*1 | P. 470 |
| ⑧ | Inside lock buttons | P. 162 |
| ⑨ | Cup holders | P. 471 |
| | Auxiliary boxes | P. 473 |
| ⑩ | Bottle holders*1 | P. 472 |

*1: If equipped

*2: Refer to "Navigation and multimedia system Owner's manual".

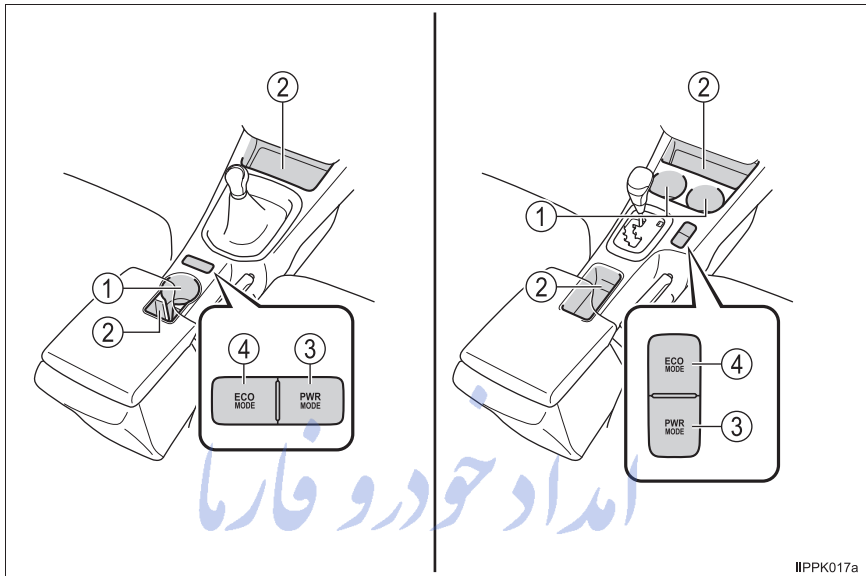

IIPPK017a

- ① Cup holders*1 P. 471
- ② Auxiliary boxes*1 P. 473
- ③ "PWR MODE" switch*1 P. 249, 255
- ④ "ECO MODE" switch*1 P. 249, 255

FarmaSOS.com

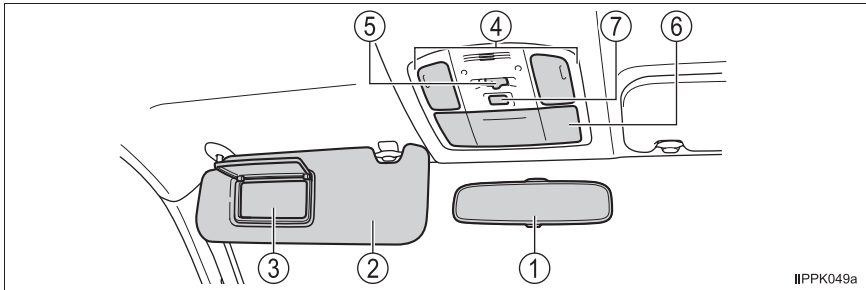

①	Inside rear view mirror	P. 196
②	Sun visors*2	P. 477
③	Vanity mirror*1	P. 477
④	Personal lights	P. 467
	Interior lights*1, 3	P. 467
⑤	Personal/interior light main switch	P. 467
⑥	Auxiliary boxes	P. 473
⑦	“SOS” button*1, 4	

تلفن شبانه روزی: ۰۲۱-۸۸۸۶۲۰۸۵

FarmaSOS.com

*1: If equipped

*2: NEVER use a rearward facing child restraint on a seat protected by an ACTIVE AIRBAG in front of it, DEATH or SERIOUS INJURY to the CHILD can occur. (→P. 71)



*3: The illustration shows the front, but they are also equipped in the rear.

*4: The button can not be used in this vehicle.

امداد خودرو فارما

تلفن شبانه روزی: ۰۲۱-۸۸۸۶۲۰۸۵

FarmaSOS.com

For safety and security

1

1-1. For safe use

Before driving.....	36
For safety drive	38
Seat belts	40
SRS airbags.....	45
Exhaust gas precautions	56

1-2. Child safety

Front passenger occupant classification system.....	57
Airbag manual on-off system	62
Riding with children.....	64
Child restraint systems	65

1-3. Theft deterrent system

Engine immobilizer system	107
Alarm	116

فارس خودرو فارما

تلفن: ۰۲۱-۸۸۸۶۲۰۸۵

FarmaSOS.com

Before driving

Floor mat

Use only floor mats designed specifically for vehicles of the same model and model year as your vehicle. Fix them securely in place onto the carpet.

- 1 Insert the retaining hooks (clips) into the floor mat eyelets.

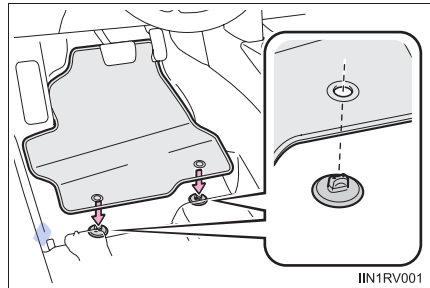

- 2 Turn the upper knob of each retaining hook (clip) to secure the floor mats in place.

*: Always align the \triangle marks.

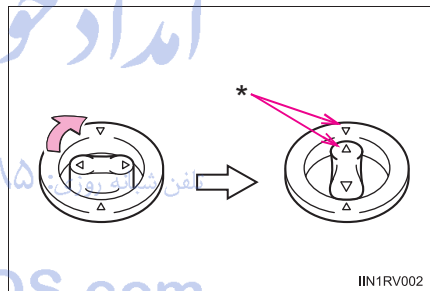

The shape of the retaining hooks (clips) may differ from that shown in the illustration.

⚠ WARNING

Observe the following precautions.

Failure to do so may cause the driver's floor mat to slip, possibly interfering with the pedals while driving. An unexpectedly high speed may result or it may become difficult to stop the vehicle. This could lead to an accident, resulting in death or serious injury.

■ When installing the driver's floor mat

- Do not use floor mats designed for other models or different model year vehicles, even if they are Toyota Genuine floor mats.
- Only use floor mats designed for the driver's seat.
- Always install the floor mat securely using the retaining hooks (clips) provided.
- Do not use two or more floor mats on top of each other.
- Do not place the floor mat bottom-side up or upside-down.

■ Before driving

- Check that the floor mat is securely fixed in the correct place with all the provided retaining hooks (clips). Be especially careful to perform this check after cleaning the floor.
- With the engine stopped and the shift lever in P (automatic transmission) or N (manual transmission), fully depress each pedal to the floor to make sure it does not interfere with the floor mat.

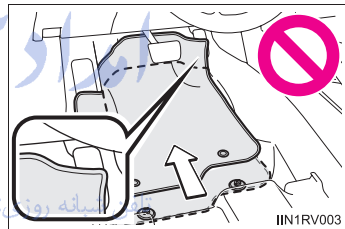

For safety drive

For safe driving, adjust the seat and mirror to an appropriate position before driving.

Correct driving posture

- ① Adjust the angle of the seat-back so that you are sitting straight up and so that you do not have to lean forward to steer. (→P. 186)
- ② Adjust the seat so that you can depress the pedals fully and so that your arms bend slightly at the elbow when gripping the steering wheel. (→P. 186)
- ③ Vehicles with adjustable type head restraint: Lock the head restraint in place with the center of the head restraint closest to the top of your ears. (→P. 191)
- ④ Wear the seat belt correctly. (→P. 40)

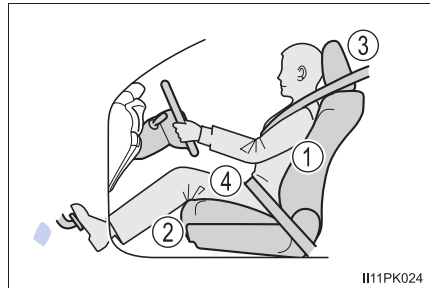

Correct use of the seat belts

Make sure that all occupants are wearing their seat belts before driving the vehicle. (→P. 40)

Use a child restraint system appropriate for the child until the child becomes large enough to properly wear the vehicle's seat belt.

(→P. 65)

Adjusting the mirrors

Make sure that you can see backward clearly by adjusting the inside and outside rear view mirrors properly. (→P. 196, 197)

WARNING

Observe the following precautions.

Failure to do so may result in death or serious injury.

- Do not adjust the position of the driver's seat while driving.
Doing so could cause the driver to lose control of the vehicle.
- Do not place a cushion between the driver or passenger and the seatback.
A cushion may prevent correct posture from being achieved, and reduce the effectiveness of the seat belt and head restraint.
- Do not place anything under the front seats.
Objects placed under the front seats may become jammed in the seat tracks and stop the seat from locking in place. This may lead to an accident and the adjustment mechanism may also be damaged.
- Always observe the legal speed limit when driving on public roads.
- When driving over long distances, take regular breaks before you start to feel tired.
Also, if you feel tired or sleepy while driving, do not force yourself to continue driving and take a break immediately.

Seat belts

Make sure that all occupants are wearing their seat belts before driving the vehicle.

Correct use of the seat belts

◆ 3-point type

- Extend the shoulder belt so that it comes fully over the shoulder, but does not come into contact with the neck or slide off the shoulder.
- Position the lap belt as low as possible over the hips.
- Adjust the position of the seatback. Sit up straight and well back in the seat.
- Do not twist the seat belt.

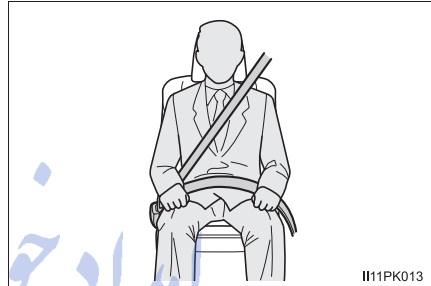

◆ 2-point type (if equipped)

- Position the lap belt as low as possible over the hips and remove excess length of the belt.
- Front seat only: Adjust the position of the seatback. Sit up straight and well back in the seat.
- Do not twist the seat belt.

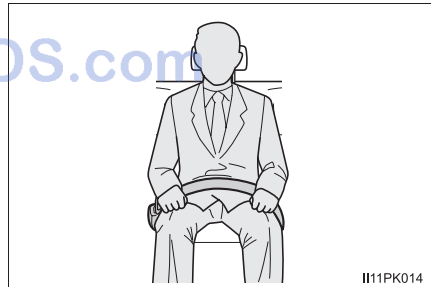

Fastening and releasing the seat belt

- ① To fasten the seat belt, push the plate into the buckle until a click sound is heard.
- ② To release the seat belt, press the release button.

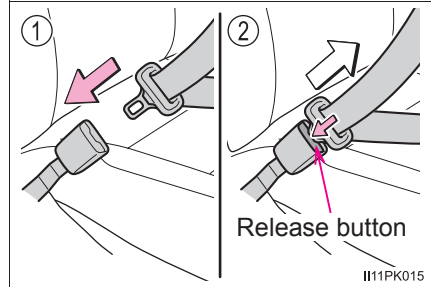

Adjusting the seat belt shoulder anchor height (if equipped for front seats)

- ① Push the seat belt shoulder anchor down while pulling the lock release knob.
 - ② Push the seat belt shoulder anchor up.
- Move the height adjuster up and down as needed until you hear a click.

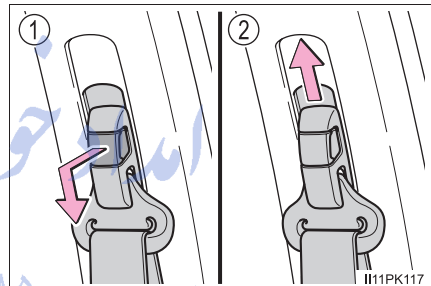

Adjusting the length of the belt (2-point type seat belt) (if equipped)

- ① Lengthen
- ② Shorten

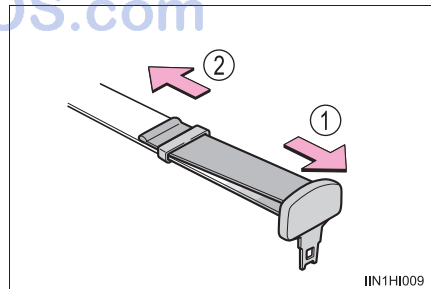

Seat belt pretensioners (if equipped)

- ▶ Vehicles without SRS side and curtain shield airbags

The pretensioners help the seat belts to quickly restrain the occupants by retracting the seat belts when the vehicle is subjected to certain types of severe frontal collision.

The pretensioners do not activate in the event of a minor frontal impact, a side impact, a rear impact or a vehicle rollover.

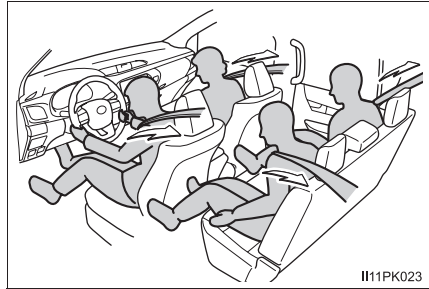

II11PK023

- ▶ Vehicles with SRS side and curtain shield airbags

The pretensioners help the seat belts to quickly restrain the occupants by retracting the seat belts when the vehicle is subjected to certain types of severe frontal or side collision.

The pretensioners do not activate in the event of a minor frontal impact, a minor side impact, a rear impact or a vehicle rollover.

■ Emergency locking retractor (ELR) (3-point type seat belt)

The retractor will lock the belt during a sudden stop or on impact. It may also lock if you lean forward too quickly. A slow, easy motion will allow the belt to extend so that you can move around fully.

■ Child seat belt usage

The seat belts of your vehicle were principally designed for persons of adult size.

- Use a child restraint system appropriate for the child, until the child becomes large enough to properly wear the vehicle's seat belt. (→ P. 65)
- When the child becomes large enough to properly wear the vehicle's seat belt, follow the instructions regarding seat belt usage. (→P. 40)

■ Replacing the belt after the pretensioner has been activated (if equipped)

If the vehicle is involved in multiple collisions, the pretensioner will activate for the first collision, but will not activate for the second or subsequent collisions.

■ Seat belt regulations

If seat belt regulations exist in the country where you reside, please contact any authorized Toyota dealer or repairer, or another duly qualified and equipped professional for seat belt replacement or installation.

⚠ WARNING

Observe the following precautions to reduce the risk of injury in the event of sudden braking, sudden swerving or an accident.

Failure to do so may cause death or serious injury.

■ **Wearing a seat belt**

- Ensure that all passengers wear a seat belt.
- Always wear a seat belt properly.
- Each seat belt should be used by one person only. Do not use a seat belt for more than one person at once, including children.
- Toyota recommends that children be seated in the rear seat and always use a seat belt and/or an appropriate child restraint system.
- To achieve a proper seating position, do not recline the seat more than necessary. The seat belt is most effective when the occupants are sitting up straight and well back in the seats.
- Do not wear the shoulder belt under your arm.
- Always wear your seat belt low and snug across your hips.

■ **Pregnant women**

Obtain medical advice and wear the seat belt in the proper way. (→P. 40)

Women who are pregnant should position the lap belt as low as possible over the hips in the same manner as other occupants, extending the shoulder belt completely over the shoulder and avoiding belt contact with the rounding of the abdominal area.

If the seat belt is not worn properly, not only the pregnant woman, but also the fetus could suffer death or serious injury as a result of sudden braking or a collision.

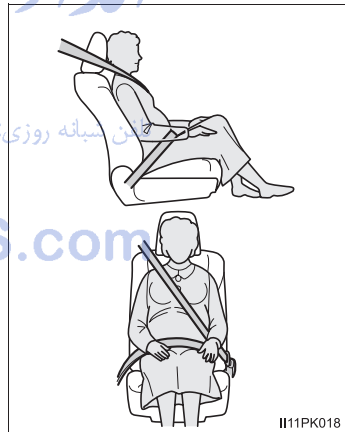

■ **People suffering illness**

Obtain medical advice and wear the seat belt in the proper way. (→P. 40)

 **WARNING****■ When children are in the vehicle**

→P. 81

■ Seat belt pretensioners (if equipped)

If the pretensioner has activated, the SRS warning light will come on. In that case, the seat belt cannot be used again and must be replaced at any authorized Toyota dealer or repairer, or another duly qualified and equipped professional.

■ Adjustable shoulder anchor (if equipped)

Always make sure the shoulder belt is positioned across the center of your shoulder. The belt should be kept away from your neck, but not falling off your shoulder. Failure to do so could reduce the amount of protection in an accident and cause death or serious injuries in the event of a sudden stop, sudden swerve or accident. (→P. 41)

■ Seat belt damage and wear

- Do not damage the seat belts by allowing the belt, plate, or buckle to be jammed in the door.
- Inspect the seat belt system periodically. Check for cuts, fraying, and loose parts. Do not use a damaged seat belt until it is replaced. Damaged seat belts cannot protect an occupant from death or serious injury.
- Ensure that the belt and plate are locked and the belt is not twisted.
If the seat belt does not function correctly, immediately contact any authorized Toyota dealer or repairer, or another duly qualified and equipped professional.
- Replace the seat assembly, including the belts, if your vehicle has been involved in a serious accident, even if there is no obvious damage.
- Do not attempt to install, remove, modify, disassemble or dispose of the seat belts. Have any necessary repairs carried out by any authorized Toyota dealer or repairer, or another duly qualified and equipped professional. Inappropriate handling may lead to incorrect operation.

SRS airbags*

The SRS airbags inflate when the vehicle is subjected to certain types of severe impacts that may cause significant injury to the occupants. They work together with the seat belts to help reduce the risk of death or serious injury.

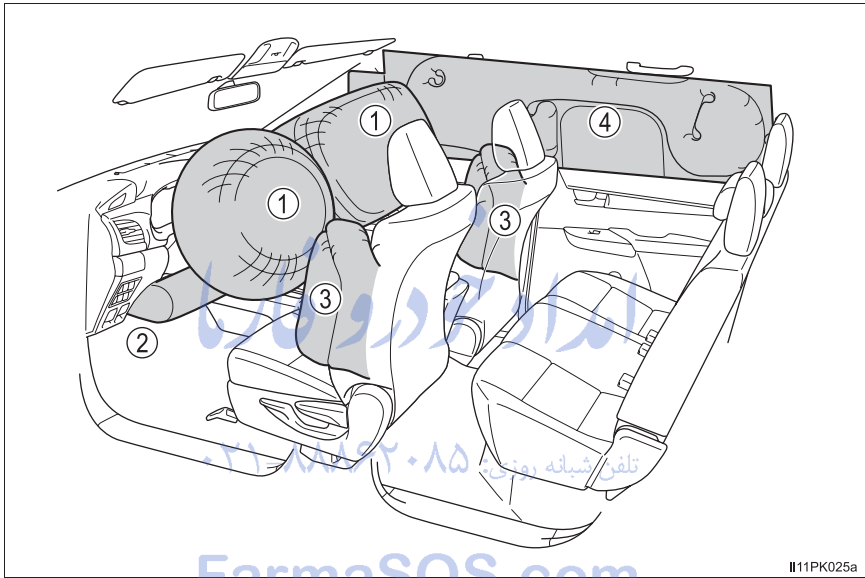

◆ SRS front airbags

- ① SRS driver airbag/front passenger airbag (if equipped)
Can help protect the head and chest of the driver and front passenger from impact with interior components
- ② SRS driver's knee airbag (if equipped)
Can help provide driver protection

◆ SRS side and curtain shield airbags

- ③ SRS side airbags (if equipped)
Can help protect the torso of the front seat occupants
- ④ SRS curtain shield airbags (if equipped)
Can help protect primarily the head of occupants in the outer seats

*: If equipped

SRS airbag system components



- | | |
|--|--|
| ① Front impact sensors | ⑧ Safing sensor (front) (if equipped) |
| ② Front passenger occupant classification system (ECU and sensors) (if equipped) | ⑨ Side airbags (if equipped) |
| ③ "PASSENGER AIR BAG" indicator (if equipped) | ⑩ Curtain shield airbags (if equipped) |
| ④ Airbag manual on-off switch (if equipped) | ⑪ Side impact sensors (rear) (if equipped) |
| ⑤ Front passenger airbag (if equipped) | ⑫ SRS warning light |
| ⑥ Side impact sensors (front door) (if equipped) | ⑬ Driver airbag |
| ⑦ Seat belt pretensioners and force limiters (if equipped) | ⑭ Driver's knee airbag (if equipped) |
| | ⑮ Airbag sensor assembly |

The main SRS airbag system components are shown above. The SRS airbag system is controlled by the airbag sensor assembly. As the airbags deploy, a chemical reaction in the inflators quickly fills the airbags with non-toxic gas to help restrain the motion of the occupants.

Bench type front seat: The SRS airbags are designed to protect the driver and front outside passenger, and they are not designed to protect an occupant in the front center seating position.

 **WARNING**

■ SRS airbag precautions

Observe the following precautions regarding the SRS airbags. Failure to do so may cause death or serious injury.

- The driver and all passengers in the vehicle must wear their seat belts properly.

The SRS airbags are supplemental devices to be used with the seat belts.

- The SRS driver airbag deploys with considerable force, and can cause death or serious injury especially if the driver is very close to the airbag.

Since the risk zone for the driver's airbag is the first 50 - 75 mm (2 - 3 in.) of inflation, placing yourself 250 mm (10 in.) from your driver airbag provides you with a clear margin of safety. This distance is measured from the center of the steering wheel to your breastbone. If you sit less than 250 mm (10 in.) away now, you can change your driving position in several ways:

- Move your seat to the rear as far as you can while still reaching the pedals comfortably.
- Slightly recline the back of the seat. Although vehicle designs vary, many drivers can achieve the 250 mm (10 in.) distance, even with the driver seat all the way forward, simply by reclining the back of the seat somewhat. If reclining the back of your seat makes it hard to see the road, raise yourself by using a firm, non-slippery cushion, or raise the seat if your vehicle has that feature.
- If your steering wheel is adjustable, tilt it downward. This points the airbag toward your chest instead of your head and neck.

The seat should be adjusted as recommended above, while still maintaining control of the foot pedals, steering wheel, and your view of the instrument panel controls.

 **WARNING**

■ **SRS airbag precautions**

- Vehicles with SRS front passenger airbag: The SRS front passenger airbag also deploys with considerable force, and can cause death or serious injury especially if the front passenger is very close to the airbag. The front passenger seat should be as far from the airbag as possible with the seat-back adjusted, so the front passenger sits upright.
- Vehicles with SRS front passenger airbag: Improperly seated and/or restrained infants and children can be killed or seriously injured by a deploying airbag. An infant or child who is too small to use a seat belt should be properly secured using a child restraint system. Toyota strongly recommends that all infants and children be placed in the rear seats (if equipped) of the vehicle and properly restrained. The rear seats (if equipped) are safer for infants and children than the front passenger seat. (→P. 65)

■ **SRS airbag precautions**

- Vehicles with SRS front passenger airbag: Do not sit on the edge of the seat or lean against the dashboard.

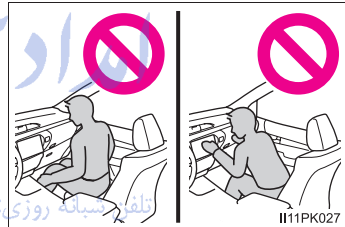

- Vehicles with SRS front passenger airbag: Do not allow a child to stand in front of the SRS front passenger airbag unit or sit on the knees of a front passenger.
- Vehicles with SRS front passenger airbag: Do not allow the front seat occupants to hold items on their knees.

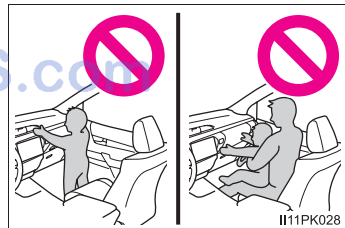

⚠ WARNING

■ SRS airbag precautions

- Vehicles with SRS side and curtain shield airbags: Do not lean against the door, the roof side rail or the front, side and rear pillars.

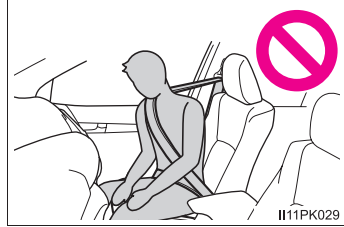

- Vehicles with SRS side and curtain shield airbags: Do not allow anyone to kneel on the passenger seat toward the door or put their head or hands outside the vehicle.

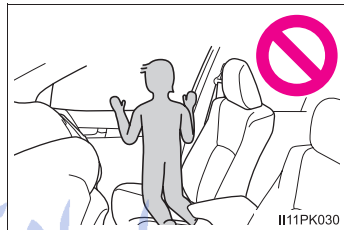

- Do not attach anything to or lean anything against areas such as the dashboard, steering wheel pad and lower portion of the instrument panel. These items can become projectiles when the SRS driver, front passenger and knee airbags (if equipped) deploy.

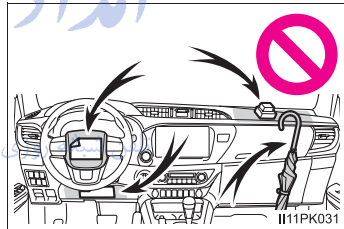

- Vehicles with SRS side and curtain shield airbags: Do not attach anything to areas such as a door, windshield glass, side door glass, front or rear pillar, roof side rail and assist grip.



⚠ WARNING

■ SRS airbag precautions

- Vehicles without smart entry & start system: Do not attach any heavy, sharp or hard objects such as keys or accessories to the key. The objects may restrict the SRS knee airbag (if equipped) inflation or be thrust into the driver's seat area by the force of the deploying airbag, thus causing a danger.

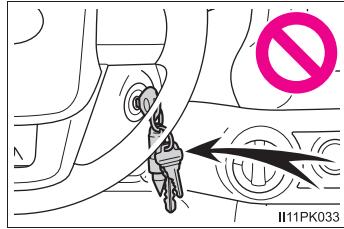

- Vehicles with SRS side and curtain shield airbags: Do not hang coat hangers or other hard objects on the coat hooks. All of these items could become projectiles and may cause death or serious injury, should the SRS curtain shield airbags deploy.
- Vehicles with SRS driver's knee airbag: If the vinyl cover is put on the area where the SRS knee airbag will deploy, be sure to remove it.
- Vehicles with SRS side and curtain shield airbags: Do not use seat accessories which cover the parts where the SRS side airbags inflate as they may interfere with inflation of the airbags. Such accessories may prevent the side airbags from activating correctly, disable the system or cause the side airbags to inflate accidentally, resulting in death or serious injury.
- Do not strike or apply significant levels of force to the area of the SRS airbag components. Doing so can cause the SRS airbags to malfunction.
- Do not touch any of the component parts immediately after the SRS airbags have deployed (inflated) as they may be hot.
- If breathing becomes difficult after the SRS airbags have deployed, open a door or window to allow fresh air in, or leave the vehicle if it is safe to do so. Wash off any residue as soon as possible to prevent skin irritation.
- Vehicles with SRS side and curtain shield airbags: If the areas where the SRS airbags are stored, such as the steering wheel pad and front and rear pillar garnishes, are damaged or cracked, have them replaced by any authorized Toyota dealer or repairer, or another duly qualified and equipped professional.
- Vehicles without SRS side and curtain shield airbags: If the areas where the SRS airbags are stored, such as the steering wheel pad, are damaged or cracked, have them replaced by any authorized Toyota dealer or repairer, or another duly qualified and equipped professional.
- Vehicles with front passenger occupant classification system: Do not place anything, such as a cushion, on the front passenger's seat. Doing so will disperse the passenger's weight, which prevents the sensor from detecting the passenger's weight properly. As a result, the SRS front airbags for the front passenger may not deploy in the event of a collision.

 **WARNING****■ Modification and disposal of SRS airbag system components**

Do not dispose of your vehicle or perform any of the following modifications without consulting any authorized Toyota dealer or repairer, or another duly qualified and equipped professional. The SRS airbags may malfunction or deploy (inflate) accidentally, causing death or serious injury.

- Installation, removal, disassembly and repair of the SRS airbags
- Repairs, modifications, removal or replacement of the steering wheel, instrument panel, dashboard, seats or seat upholstery, front, side and rear pillars or roof side rails
- Repairs or modifications of the front fender, front bumper, or side of the occupant compartment
- Installation of a grille guard (bull bars, kangaroo bar, etc.), snow plows or winches
- Modifications to the vehicle's suspension system
- Installation of electronic devices such as mobile two-way radios (RF-transmitter) and CD players

امداد خودرو فارما
تلفن شبانه روزی: ۰۲۱-۸۸۸۶۲۰۸۵

FarmaSOS.com

■ If the SRS airbags deploy (inflate)

- Slight abrasions, burns, bruising etc., may be sustained from SRS airbags, due to the extremely high speed deployment (inflation) by hot gases.
- A loud noise and white powder will be emitted.
- Vehicles without SRS curtain shield airbags: Parts of the airbag module (steering wheel hub, airbag cover and inflator) as well as the front seats may be hot for several minutes. The airbag itself may also be hot.
- Vehicles with SRS curtain shield airbags: Parts of the airbag module (steering wheel hub, airbag cover and inflator) as well as the front seats, parts of the front and rear pillars, and roof side rails, may be hot for several minutes. The airbag itself may also be hot.
- The windshield may crack.
- Vehicles with ERA-GLONASS: If the SRS airbags deploy, the system is designed to send an emergency call to the Public Safety Answering Point (PSAP), notifying them of the vehicle's location (without needing to push the "SOS" button) and an agent will attempt to speak with the occupants to ascertain the level of emergency and assistance required. If the occupants are unable to communicate, the agent automatically treats the call as an emergency and helps to dispatch the necessary emergency services. (→P. 483)

■ SRS airbag deployment conditions (SRS front airbags)

- The SRS front airbags will deploy in the event of an impact that exceeds the set threshold level (the level of force corresponding to an approximately 20 - 30 km/h [12 - 18 mph] frontal collision with a fixed wall that does not move or deform).

However, this threshold velocity will be considerably higher in the following situations:

- If the vehicle strikes an object, such as a parked vehicle or sign pole, which can move or deform on impact
- If the vehicle is involved in an underride collision, such as a collision in which the front of the vehicle "underrides", or goes under, the bed of a truck
- Depending on the type of collision, it is possible that only the seat belt pretensioners will activate.
- Vehicles with front passenger occupant classification system: The SRS front airbags for the front passenger will not activate if there is no passenger sitting in the front passenger seat. However, the SRS front airbags for the front passenger may deploy if luggage is put in the seat, even if the seat is unoccupied.

■ SRS airbag deployment conditions (SRS side and curtain shield airbags)

- The SRS side and curtain shield airbags will deploy in the event of an impact that exceeds the set threshold level (the level of force corresponding to the impact force produced by an approximately 1500 kg [3300 lb.] vehicle colliding with the vehicle cabin from a direction perpendicular to the vehicle orientation at an approximate speed of 20 - 30 km/h [12 - 18 mph]).
- The SRS side and curtain shield airbags may also deploy in the event of a severe frontal collision.

■ Conditions under which the SRS airbags may deploy (inflate), other than a collision

The SRS front airbags, SRS side and curtain shield airbags may also deploy if a serious impact occurs to the underside of your vehicle. Some examples are shown in the illustration.

- Hitting a curb, edge of pavement or hard surface
- Falling into or jumping over a deep hole
- Landing hard or falling

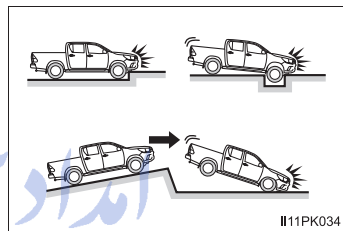

■ Types of collisions that may not deploy the SRS airbags (SRS front airbags)

The SRS front airbags do not generally inflate if the vehicle is involved in a side or rear collision, if it rolls over, or if it is involved in a low-speed frontal collision. But, whenever a collision of any type causes sufficient forward deceleration of the vehicle, deployment of the SRS front airbags may occur.

- Collision from the side
- Collision from the rear
- Vehicle rollover

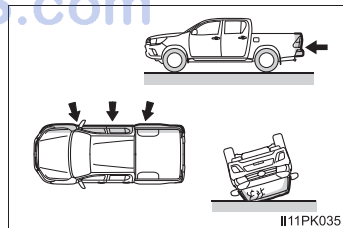

■ Types of collisions that may not deploy the SRS airbags (SRS side and curtain shield airbags)

The SRS side and curtain shield airbags may not activate if the vehicle is subjected to a collision from the side at certain angles, or a collision to the side of the vehicle body other than the passenger compartment.

- Collision from the side to the vehicle body other than the passenger compartment
- Collision from the side at an angle

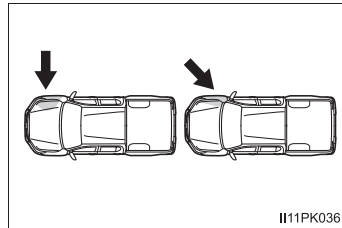

The SRS side and curtain shield airbags do not generally inflate if the vehicle is involved in a rear collision, if it rolls over, or if it is involved in a low-speed side or low-speed frontal collision.

- Collision from the rear
- Vehicle rollover

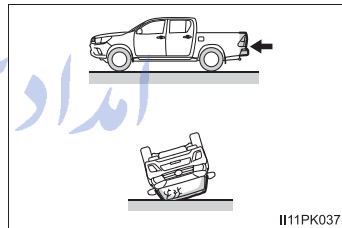

■ When to contact any authorized Toyota dealer or repairer, or another duly qualified and equipped professional

In the following cases, the vehicle will require inspection and/or repair. Contact any authorized Toyota dealer or repairer, or another duly qualified and equipped professional as soon as possible.

- Any of the SRS airbags have been inflated.
- The front of the vehicle is damaged or deformed, or was involved in an accident that was not severe enough to cause the SRS airbags to inflate.

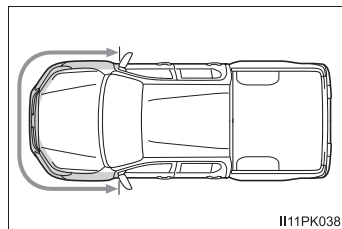

- Vehicles with SRS side and curtain shield airbags: A portion of a door or its surrounding area is damaged or deformed, or the vehicle was involved in an accident that was not severe enough to cause the SRS side and curtain shield airbags to inflate.

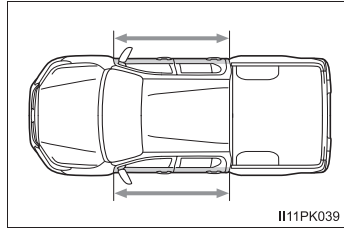

- Vehicles without SRS driver's knee airbag: The pad section of the steering wheel or dashboard near the front passenger airbag is scratched, cracked, or otherwise damaged.

Vehicles with SRS driver's knee airbag: The pad section of the steering wheel, dashboard near the front passenger airbag cover or lower portion of the instrument panel is scratched, cracked, or otherwise damaged.

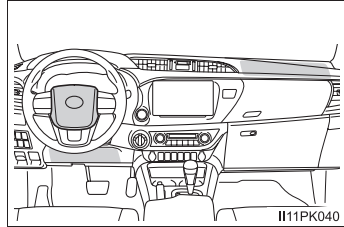

- Vehicles with SRS side airbags: The surface of the seats with the side airbag is scratched, cracked, or otherwise damaged.

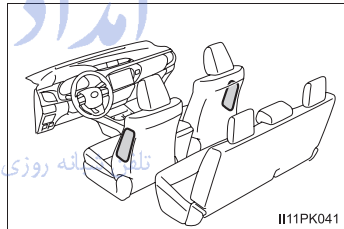

- Vehicles with SRS curtain shield airbags: The portion of the front pillars, rear pillars or roof side rail garnishes (padding) containing the curtain shield airbags inside is scratched, cracked, or otherwise damaged.

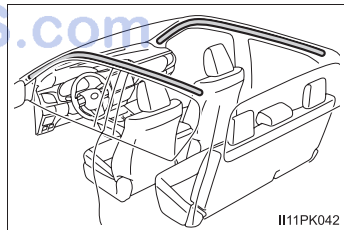

Exhaust gas precautions

Harmful substance to the human body is included in exhaust gases if inhaled.

WARNING

Exhaust gases include harmful carbon monoxide (CO), which is colorless and odorless. Observe the following precautions.

Failure to do so may cause exhaust gases enter the vehicle and may lead to an accident caused by light-headedness, or may lead to death or a serious health hazard.

■ Important points while driving

If you smell exhaust gases in the vehicle, open the windows and have the vehicle inspected at any authorized Toyota dealer or repairer, or another duly qualified and equipped professional as soon as possible.

■ When parking

- If the vehicle is in a poorly ventilated area or a closed area, such as a garage, stop the engine.
- Do not leave the vehicle with the engine running for a long time.
If such a situation cannot be avoided, park the vehicle in an open space and ensure that exhaust fumes do not enter the vehicle interior.
- Do not leave the engine running in an area with snow build-up, or where it is snowing. If snowbanks build up around the vehicle while the engine is running, exhaust gases may collect and enter the vehicle.

■ Exhaust pipe

The exhaust system needs to be checked periodically. If there is a hole or crack caused by corrosion, damage to a joint or abnormal exhaust noise, be sure to have the vehicle inspected and repaired by any authorized Toyota dealer or repairer, or another duly qualified and equipped professional.

Front passenger occupant classification system*

Your vehicle is equipped with a front passenger occupant classification system. This system detects the conditions of the front passenger seat and activates or deactivates the devices for the front passenger.

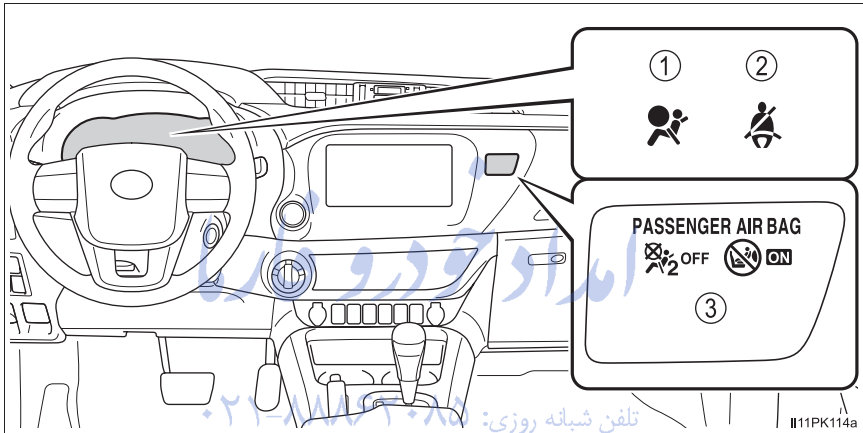

- ① SRS warning light
- ② Seat belt reminder light
- ③ “PASSENGER AIR BAG” indicator

Vehicles without smart entry & start system: The ON indicator light turns on when the airbag system is on (only when the engine switch is in the “ON” position).

Vehicles with smart entry & start system: The ON indicator light turns on when the airbag system is on (only when the engine switch is in IGNITION ON mode).

*: If equipped

Condition and operation in the front passenger occupant classification system

■ Adult*1

Indicator/ warning light	"PASSENGER AIR BAG" indicator	ON indicator
	SRS warning light	Off
	Seat belt reminder light	Off*2 or flashing*3
Devices	Front passenger airbag	Activated
	Side airbag on the front passenger seat	
	Curtain shield airbag in the front passenger side	
	Front passenger's seat belt pretensioner	

■ Child*4 or child restraint system*5

Indicator/ warning light	"PASSENGER AIR BAG" indicator	OFF indicator*6
	SRS warning light	Off
	Seat belt reminder light	Off*2 or flashing*3
Devices	Front passenger airbag	Deactivated
	Side airbag on the front passenger seat	Activated
	Curtain shield airbag in the front passenger side	
	Front passenger's seat belt pretensioner	

■ Unoccupied

Indicator/ warning light	“PASSENGER AIR BAG” indicator	Not illuminated
	SRS warning light	Off
	Seat belt reminder light	
Devices	Front passenger airbag	Deactivated
	Side airbag on the front passenger seat	Activated
	Curtain shield airbag in the front passenger side	
	Front passenger’s seat belt pretensioner	Activated* ⁷ or deactivated* ⁸

■ There is a malfunction in the system

Indicator/ warning light	“PASSENGER AIR BAG” indicator	OFF indicator
	SRS warning light	On
	Seat belt reminder light	flashing
Devices	Front passenger airbag	Deactivated
	Side airbag on the front passenger seat	Activated
	Curtain shield airbag in the front passenger side	
	Front passenger’s seat belt pretensioner	

- *1: The system judges a person of adult size as an adult. When a smaller adult sits in the front passenger seat, the system may recognize him/her as a child depending on his/her physique and posture.
- *2: In the event the front passenger is wearing a seat belt.
- *3: In the event the front passenger does not wear a seat belt.
- *4: When a larger child who has outgrown a child restraint system sits in the front passenger seat, the system may recognize him/her as an adult depending on his/her physique or posture.
- *5: For the child's safety, install the child restraint system to a rear seat. When it is unavoidable, a child restraint system can be installed on the front passenger seat. A rear-facing child restraint system should be installed when "OFF" of the "PASSENGER AIR BAG" indicator is illuminated. (→P. 65)
- *6: In case the indicator light is not illuminated, consult this manual on how to install the child restraint system properly. (→P. 65)
- *7: In the event of a side collision.
- *8: In the event of a frontal collision.

 **WARNING**

■ Front passenger occupant classification system precautions

Observe the following precautions regarding the front passenger occupant classification system.

Failure to do so may cause death or serious injury.

- Wear the seat belt properly.
- Make sure the front passenger's seat belt plate has not been left inserted into the buckle before someone sits in the front passenger seat.
- Do not apply a heavy load to the front passenger seat or equipment (e.g. seatback pocket or armrest).
- Do not put weight on the front passenger seat by putting your hands or feet on the front passenger seat seatback from the rear passenger seat.
- Do not let a rear passenger lift the front passenger seat with their feet or press on the seatback with their legs.
- Do not put objects under the front passenger seat.

 **WARNING****■ Front passenger occupant classification system precautions**

- Do not recline the front passenger seatback so far that it touches a rear seat. This may cause “OFF” of the “PASSENGER AIR BAG” indicator to be illuminated, which indicates that the SRS airbags for the front passenger will not activate in the event of a severe accident. If the seatback touches the rear seat, return the seatback to a position where it does not touch the rear seat. Keep the front passenger seatback as upright as possible when the vehicle is moving. Reclining the seatback excessively may lessen the effectiveness of the seat belt system.
- If an adult sits in the front passenger seat, “ON” of the “PASSENGER AIR BAG” indicator is illuminated. If “OFF” of the “PASSENGER AIR BAG” indicator is illuminated, ask the passenger to sit up straight, well back in the seat, feet on the floor, and with the seat belt worn correctly. If “OFF” of the “PASSENGER AIR BAG” indicator still remains illuminated, either ask the passenger to move to the rear seat, or if that is not possible, move the front passenger seat fully rearward.
- When it is unavoidable to install a child restraint system on the front passenger seat, install the child restraint system on the front passenger seat in the proper order. (→P. 65)
- Do not modify or remove the front seats.
- Do not kick the front passenger seat or subject it to severe impact. Otherwise, the SRS warning light may come on to indicate a malfunction of the front passenger occupant classification system. In this case, contact any authorized Toyota dealer or repairer, or another duly qualified and equipped professional immediately.
- Child restraint systems installed on the rear seat should not contact the front seatbacks.
- Do not use a seat accessory, such as a cushion and seat cover, that covers the seat cushion surface.
- Do not modify or replace the upholstery of the front seat.
- When it is unavoidable to install a rear-facing child restraint system on the front passenger seat, do not release the seat belt while the vehicle is moving. Doing so may cause the airbag system to be on.

Airbag manual on-off system*

**This system deactivates the front passenger airbag.
Only deactivate the airbag when using a child restraint system
on the front passenger seat.**

① “PASSENGER AIR BAG” indicator

Vehicles without smart entry & start system: The ON indicator light turns on when the airbag system is on (only when the engine switch is in the “ON” position).

Vehicles with smart entry & start system: The ON indicator light turns on when the airbag system is on (only when the engine switch is in IGNITION ON mode).

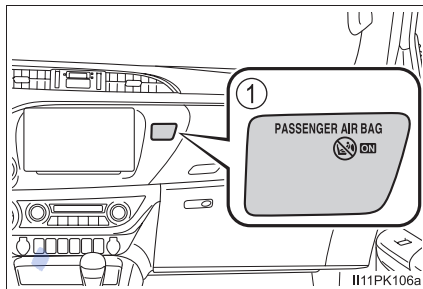

② Airbag manual on-off switch

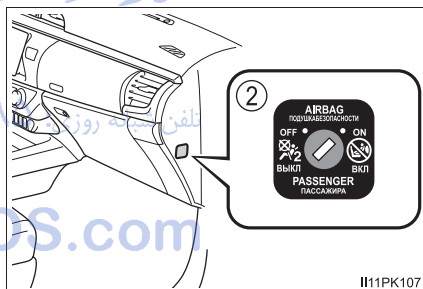

*: If equipped

Deactivating the front seat passenger airbag

Vehicles without smart entry & start system:

Insert the key into the cylinder and turn to the “OFF” position.

The OFF indicator light turns on (only when the engine switch is in the “ON” position).

Vehicles with smart entry & start system:

Insert the mechanical key into the cylinder and rotate to the “OFF” position.

The OFF indicator light turns on (only when the engine switch is in IGNITION ON mode).

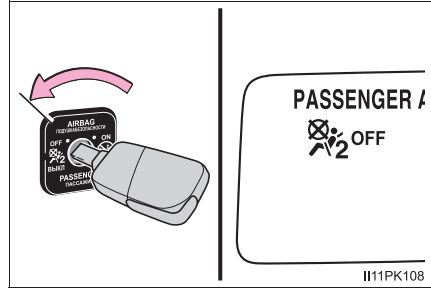

■ “PASSENGER AIR BAG” indicator lights information

If any of the following problems occur, it is possible that there is a malfunction in the system. Have the vehicle inspected by any authorized Toyota dealer or repairer, or another duly qualified and equipped professional.

- Neither “ON” nor “OFF” comes on.
- The indicator light does not change when the airbag manual on-off switch is switched to “ON” or “OFF”.

⚠ WARNING

■ When installing a child restraint system

For safety reasons, always install the child restraint system in a rear seat. In the event that the rear seat cannot be used, the front seat can be used as long as the airbag manual on-off system is set to “OFF”.

If the airbag manual on-off system is left on, the strong impact of the airbag deployment (inflation) may cause serious injury or even death.

■ When a child restraint system is not installed on the front passenger seat

Ensure that the airbag manual on-off system is set to “ON”.

If it is left off, the airbag may not deploy in the event of an accident, which may result in serious injury or even death.

Riding with children

Observe the following precautions when children are in the vehicle.

Use a child restraint system appropriate for the child, until the child becomes large enough to properly wear the vehicle's seat belt.

- It is recommended that children sit in the rear seats (if equipped) to avoid accidental contact with the shift lever, wiper switch etc.
- Use the rear door child-protector lock (double-cab models only) or the window lock switch (vehicles with power windows) to avoid children opening the door while driving or operating the power window accidentally.
- Do not let small children operate equipment which may catch or pinch body parts, such as the power window (if equipped), hood, tailgate (if equipped), seats etc.

WARNING

Never leave children unattended in the vehicle, and never allow children to have or use the key.

Children may be able to start the vehicle or shift the vehicle into neutral. There is also a danger that children may injure themselves by playing with the windows or other features of the vehicle. In addition, heat build-up or extremely cold temperatures inside the vehicle can be fatal to children.

Child restraint systems

Before installing a child restraint system in the vehicle, there are precautions that need to be observed, different types of child restraint systems, as well as installation methods, etc., written in this manual.

- Use a child restraint system when riding with a small child that can not properly use a seat belt. For the child's safety, install the child restraint system to a rear seat. Be sure to follow the installation method that is in the operation manual enclosed with the restraint system.
- Except for Kazakhstan: The use of a Toyota genuine child restraint system is recommended, as it is safer to use in this vehicle. Toyota genuine child restraint systems are made specifically for Toyota vehicles. They can be purchased at a Toyota dealer.

Table of contents

Points to remember.....	P. 65
Child restraint system.....	P. 67
When using a child restraint system	P. 70
Child restraint system installation method	
• Fixed with a seat belt (except for Kazakhstan)	P. 73
• Fixed with a seat belt (for Kazakhstan).....	P. 82
• Fixed with an ISOFIX rigid anchor (if equipped except for Kazakhstan).....	P. 89
• Fixed with an ISOFIX rigid anchor (for Kazakhstan)	P. 97
• Using an anchor bracket (for top strap) (if equipped).....	P. 104

Points to remember

- Prioritize and observe the warnings, as well as the laws and regulations for child restraint systems.
- Choose a child restraint system that suits your vehicle and is appropriate to the age and size of the child.
- Use a child restraint system appropriate for the child until the child becomes large enough to properly wear the vehicle's seat belt.

 **WARNING****■ When a child is riding**

Observe the following precautions.

Failure to do so may result in death or serious injury.

- For effective protection in automobile accidents and sudden stops, a child must be properly restrained, using a seat belt or child restraint system depending on the age and size of the child.
- Toyota strongly urges the use of a proper child restraint system that conforms to the size of the child, installed on the rear seat. According to accident statistics, the child is safer when properly restrained in the rear seat than in the front seat.
- Holding a child in your or someone else's arms is not a substitute for a child restraint system. In an accident, the child can be crushed against the windshield or between the holder and the interior of the vehicle.

■ Handling the child restraint system

If the child restraint system is not properly fixed in place, the child or other passengers may be seriously injured or even killed in the event of sudden braking, sudden swerving, or an accident.

- If the vehicle were to receive a strong impact from an accident, etc., it is possible that the child restraint system has damage that is not readily visible. In such cases, do not reuse the restraint system.
- Depending on the child restraint system, installation may be difficult or impossible. In those cases, check whether the child restraint system is suitable for installment in the vehicle. (→P. 73, 82, 89, 97) Be sure to install and observe the usage rules after carefully reading the child restraint system fixing method in this manual, as well as the operation manual enclosed with the child restraint system.
- Keep the child restraint system properly secured on the seat even if it is not in use. Do not store the child restraint system unsecured in the passenger compartment.
- If it is necessary to detach the child restraint system, remove it from the vehicle.

Child restraint system

Install the available child restraint system in vehicle upon confirming the following items.

■ Standards for child restraint systems

Use a child restraint system that conforms to ECE R44*¹ or ECE R129*^{1, 2}.

The following approval mark is displayed on child restraint systems which are conformed.

Check for an approval mark attached to the child restraint system.

Example of the displayed regulation number

- ① ECE R44 approval mark*³
The weight range of the child who is applicable for an ECE R44 approval mark is indicated.
- ② ECE R129 approval mark*³
The height range of the child who is applicable as well as available weights for an ECE R129 approval mark is indicated.

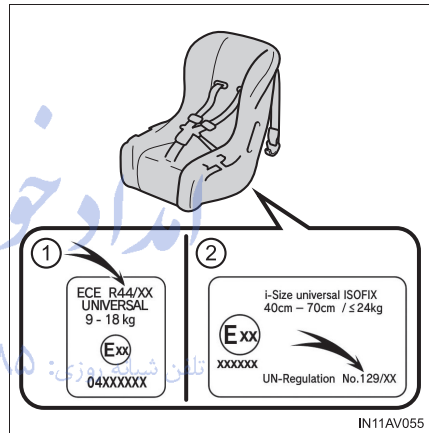

- *¹: ECE R44 and ECE R129 are U.N. regulations for child restraint systems.
- *²: The child restraint systems mentioned in the table may not be available outside of the EU area.
- *³: The displayed mark may differ depending on the product.

■ Mass group (ECE R44 only)

This Mass group table is required when confirming the child restraint system compatibility. Confirm in accordance with the child restraint system compatibility table. (→P. 73, 82, 91, 99).

The child restraint system which conforms to the standard of ECE R44 is categorized into 5 groups according to the weight of the child.

Mass group	Child weight	Reference age*
Group 0	until 10 kg (22 lb.)	about 9 months
Group 0+	until 13 kg (28 lb.)	about 1.5 years
Group I	9 - 18 kg (20 to 39 lb.)	from 9 months - about 4 years
Group II	15 - 25 kg (34 to 55 lb.)	from 3 years - about 7 years
Group III	22 - 36 kg (49 to 79 lb.)	from 6 years - about 12 years

*: The age range is a standard approximation. Choose according to the weight of the child.

تلفن شبانه روزی: ۰۲۱-۸۸۸۶۲۰۸۵

FarmaSOS.com

■ Types of child restraint system installation methods

Confirm with the operation manual enclosed with the child restraint system about the instruction of the child restraint system.

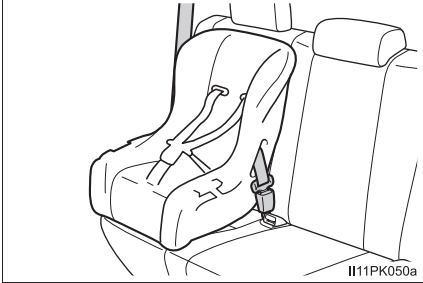
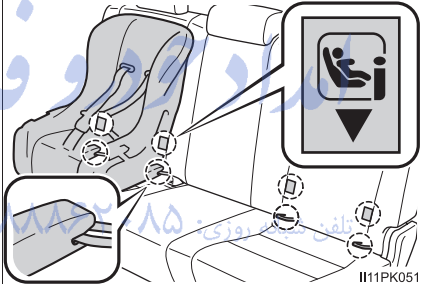
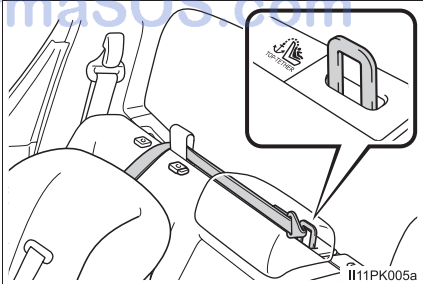
	Installation method	Page
<p>Seat belt attachment</p>		<p>P. 73, 82</p>
<p>ISOFIX rigid anchor attachment</p>		<p>P. 89, 97</p>
<p>Anchor brackets (for top strap) attachment</p>		<p>P. 104</p>

When using a child restraint system

⚠ WARNING

■ When using a child restraint system

Observe the following precautions.

Failure to do so may result in death or serious injury.

- Vehicles without front passenger occupant classification system or airbag manual on-off switch: Never use a rear-facing child restraint system on the front passenger seat.

The force of the rapid inflation of the front passenger airbag can cause death or serious injury to children in the event of an accident.

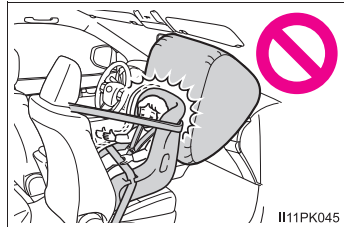

- Vehicles with front passenger occupant classification system: Never use a rear-facing child restraint system on the front passenger seat when "ON" of the "PASSENGER AIR BAG" indicator is illuminated. (→P. 57)
The force of the rapid inflation of the front passenger airbag can cause death or serious injury to children in the event of an accident.

- Vehicles with airbag manual on-off switch: Never use a rear-facing child restraint system on the front passenger seat when the airbag manual on-off switch is on. (→P. 62)

The force of the rapid inflation of the front passenger airbag can cause death or serious injury to children in the event of an accident.

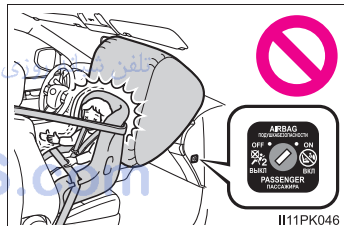

- On some models: There is a label(s) on the passenger side sun visor, indicating it is forbidden to attach a rear-facing child restraint system to the front passenger seat.

Details of the label(s) are shown in the illustration below. The label type B includes information written in the language of your country.

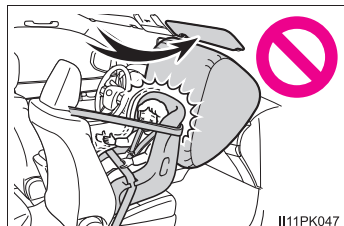

⚠ WARNING

► Type A



IT1171118a

► Type B

⚠ 警告 ⚠ WARNING ⚠ تحذير

为 避免 人 身 伤 亡 事 故:

- 对 于 儿 童, 后 排 座 位 是 最 安 全 的。
- 应 尽 可 能 坐 在 远 离 充 气 囊 的 后 方。
- 无 论 什 么 时 候 都 要 系 好 安 全 带, 使 用 儿 童 安 全 保 护 系 统。

ي مكن أن ت ُح َد ِث ُ ِإ ِص َابة َخط ِيرة َأو َوف ِاة

- الم ِقع ِد ِالخ ِلف ِي َهو َأ َكثر ِالأ ِم ِاكن ِأ ِمن ِا للأ ِط ِفال.
- ا ِج ِلس ِف ِي ِالم ِقع ِد ِم ِبت ِعد ِا ع ِند ِالم ِست ِط ِاع ِع ِن ِك ِيس ِاله ِوا.
- إ ِست ِخد ِم ِد ِائ ِم ِا أ ِح ِزمة ِالم ِقع ِد ِوأ ِن ِظ ِمة ِت ِث ِب ِيت ِال ِطف ِل.

DEATH or SERIOUS INJURY can occur

- ALWAYS use SEAT BELTS and CHILD RESTRAINTS
- The BACK SEAT is the SAFEST place for children
- Sit as far back as possible from the air bag

II11PK119

⚠ WARNING

■ When using a child restraint system

- Vehicles with SRS front passenger air-bag: Only put a forward-facing child restraint system on the front seat when unavoidable. When installing a forward-facing child restraint on the front passenger seat, move the seat as far back as possible. Failing to do so may result in death or serious injury if the airbags deploy (inflate).

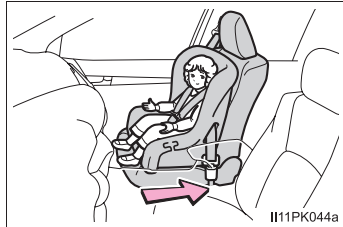

- Vehicles with SRS side and curtain shield airbags: Do not allow the child to lean his/her head or any part of his/her body against the door or the area of the seat, front or rear pillars, or roof side rails from which the SRS side airbags or SRS curtain shield airbags deploy even if the child is seated in the child restraint system. It is dangerous if the SRS side airbags and curtain shield airbags inflate, and the impact could cause death or serious injury to the child.
- When a junior seat is installed, always ensure that the shoulder belt is positioned across the center of the child's shoulder. The belt should be kept away from the child's neck, but not so that it could fall off the child's shoulder.
- Use child restraint system suitable to the age and size of the child and install it to the rear seat.

- Double-cab models: If the driver's seat interferes with the child restraint system and prevents it from being attached correctly, attach the child restraint system to the right-hand rear seat (left-hand drive vehicles) or the left-hand rear seat (right-hand drive vehicles). (→P. 79, 93)

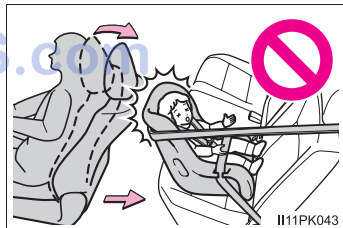

- Double-cab models: Adjust the front passenger seat so that it does not interfere with the child restraint system.

Child restraint system fixed with a seat belt (except for Kazakhstan)

◆ Confirming the possible installation seating positions and the Mass Group for the seat belt installation type child restraint systems.

- 1 Confirm the corresponding [Mass group] from the weight of the child (→P. 68)
(Ex. 1) When the weight is 12 kg, [Mass group 0+]
(Ex. 2) When the weight is 15 kg, [Mass group I]
- 2 Confirm and select the appropriate possible seating position for the child restraint system and the corresponding type of system from the [Child restraint systems fastened with SEAT BELT - Compatibility and Recommended child restraint systems table].
(→P. 73)

◆ Child restraint systems fastened with SEAT BELT - Compatibility and Recommended child restraint systems table

If your child restraint system is of “universal” category, you can install it on the positions mentioned by U or UF in the table below (UF is for forward-facing child restraint systems only). Child restraint systems category and mass group can be found in the child restraint system manual.

If your child restraint system is not of the “universal” category (or if you cannot find information in the table below), please refer to the child restraint system “vehicle list” for compatibility information or ask the retailer of your child seat.

► Single-cab models

Mass groups	Seating position		Recommended Child Restraint Systems
	Front passenger seat		
	Vehicles with front passenger occupant classification system		
	Passenger airbag indicator light		
	ON	OFF* ³	
0 Up to 10 kg (22 lb.)	X	U* ¹ L* ¹	“TOYOTA G 0+, BABYSAFE PLUS” “TOYOTA MINI”
0+ Up to 13 kg (28 lb.)	X	U* ¹ L* ¹	“TOYOTA G 0+, BABYSAFE PLUS with SEAT BELT FIXATION, BASE PLATFORM”
I 9 to 18 kg (20 to 39 lb.)	Rearward-facing — X	U* ^{1, 2}	“TOYOTA DUO+”
	Forward-facing — UF* ^{1, 2}		
II, III 15 to 36 kg (34 to 79 lb.)	UF* ^{1, 2}	U* ^{1, 2}	“TOYOTA KIDFIX XP SICT”

Key of letters inserted in the above table:

X: Not suitable seat position for children in this mass group.

U: Suitable for “universal” category child restraint systems approved for use in this mass group.

UF: Suitable for forward-facing “universal” category child restraint systems approved for use in this mass group.

L: Suitable for “specific vehicles”, “restricted”, or “semi-universal”, category child restraint systems approved for use in this mass group.

*1: Adjust the seatback angle to the most upright position. Move the front seat fully rearward. If the passenger seat height can be adjusted, move it to the upper most position.

- *2: If the head restraint interferes with your child restraint system, and the head restraint can be removed, remove the head restraint. Otherwise, put the head restraint in the upper most position.
- *3: When it is unavoidable to install a rear-facing child restraint system on the front passenger seat, a child restraint system can be installed if the PASSENGER AIRBAG OFF indicator lamp is lit.

► Smart-cab models

Mass groups	Seating position		Rear seat	Recommended Child Restraint Systems
	Front passenger seat			
	Vehicles with front passenger occupant classification system			
	Passenger airbag indicator light			
	ON	OFF* ³		
0 Up to 10 kg (22 lb.)	X	U* ¹ L* ¹	X	"TOYOTA G 0+, BABY SAFE PLUS" "TOYOTA MINI"
0+ Up to 13 kg (28 lb.)	X	U* ¹ L* ¹	X	"TOYOTA G 0+, BABY SAFE PLUS with SEAT BELT FIXATION, BASE PLATFORM"
I 9 to 18 kg (20 to 39 lb.)	Rearward-facing — X	U* ^{1, 2}	X	"TOYOTA DUO+"
	Forward-facing — UF* ^{1, 2}			
II, III 15 to 36 kg (34 to 79 lb.)	UF* ^{1, 2}	U* ^{1, 2}	X	"TOYOTA KIDFIX XP SICT"

Key of letters inserted in the above table:

X: Not suitable seat position for children in this mass group.

U: Suitable for "universal" category child restraint systems approved for use in this mass group.

- UF: Suitable for forward-facing “universal” category child restraint systems approved for use in this mass group.
- L: Suitable for “specific vehicles”, “restricted”, or “semi-universal”, category child restraint systems approved for use in this mass group.
- *1: Adjust the seatback angle to the most upright position. Move the front seat fully rearward. If the passenger seat height can be adjusted, move it to the upper most position.
- *2: If the head restraint interferes with your child restraint system, and the head restraint can be removed, remove the head restraint. Otherwise, put the head restraint in the upper most position.
- *3: When it is unavoidable to install a rear-facing child restraint system on the front passenger seat, a child restraint system can be installed if the PASSENGER AIRBAG OFF indicator lamp is lit.

امداد خودرو فارما

تلفن شبانه روزی: ۰۲۱-۸۸۸۶۲۰۸۵

FarmaSOS.com

► Double-cab models

Mass groups	Seating position						Recommended Child Restraint Systems
	Front passenger seat				Rear seat		
	Vehicles with airbag manual on-off switch		Vehicles with front passenger occupant classification system		Out-board	Center	
	Airbag manual on-off switch		Passenger airbag indicator light				
	ON	OFF	ON	OFF* ³			
0 Up to 10 kg (22 lb.)	X	U* ¹ L* ¹	X	U* ¹ L* ¹	U L	X	“TOYOTA G 0+, BABY SAFE PLUS”
0+ Up to 13 kg (28 lb.)	X	U* ¹ L* ¹	X	U* ¹ L* ¹	U L	X	“TOYOTA MINI” “TOYOTA G 0+, BABY SAFE PLUS with SEAT BELT FIXATION, BASE PLATFORM”
I 9 to 18 kg (20 to 39 lb.)	Rearward-facing — X	U* ^{1, 2}	Rearward-facing — X	U* ^{1, 2}	U* ²	X	“TOYOTA DUO+”
	Forward-facing — UF* ^{1, 2}		Forward-facing — UF* ^{1, 2}				
II, III 15 to 36 kg (34 to 79 lb.)	UF* ^{1, 2}	U* ^{1, 2}	UF* ^{1, 2}	U* ^{1, 2}	U* ²	X	“TOYOTA KIDFIX XP SICT” (Can be fitted to the vehicle’s ISOFIX mountings.)

Key of letters inserted in the above table:

X: Not suitable seat position for children in this mass group.

U: Suitable for “universal” category child restraint systems approved for use in this mass group.

UF: Suitable for forward-facing “universal” category child restraint systems approved for use in this mass group.

L: Suitable for “specific vehicles”, “restricted”, or “semi-universal”, category child restraint systems approved for use in this mass group.

*1: Adjust the seatback angle to the most upright position. Move the front seat fully rearward. If the passenger seat height can be adjusted, move it to the upper most position.

*2: If the head restraint interferes with your child restraint system, and the head restraint can be removed, remove the head restraint. Otherwise, put the head restraint in the upper most position.

*3: When it is unavoidable to install a rear-facing child restraint system on the front passenger seat, a child restraint system can be installed if the PASSENGER AIRBAG OFF indicator lamp is lit.

Double-cab models: When securing some types of child restraint systems in rear seat, it may not be possible to properly use the seat belts in positions next to the child restraint without interfering with it or affecting seat belt effectiveness. Be sure your seat belt fits snugly across your shoulder and low on your hips. If it does not, or if it interferes with the child restraint, move to a different position. Failure to do so may result in death or serious injury.

The child restraint systems mentioned in the table may not be available outside the EU area.

- Double-cab models: When installing a child restraint in the rear seats, adjust the front seat so that it does not interfere with the child or child restraint system.
- When installing a child seat with support base, if the child seat interferes with the seatback when latching it into the support base, adjust the seatback rearward until there is no interference.

- When installing a forward-facing child seat, if there is a gap between the child seat and the seatback, adjust the seatback angle until good contact is achieved.

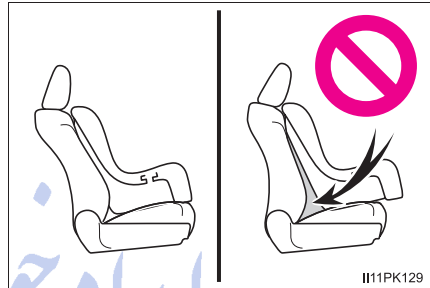

- If the seat belt shoulder anchor is ahead of the child seat belt guide, move the seat cushion forward.

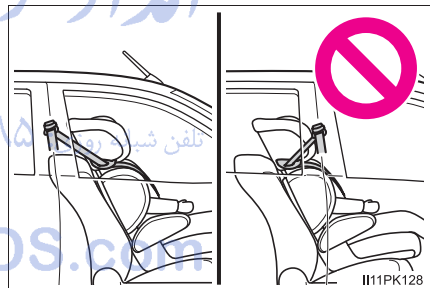

- When installing a junior seat, if the child in your child restraint system is in a very upright position, adjust the seatback angle to the most comfortable position. And if the seat belt shoulder anchor is ahead of the child seat belt guide, move the seat cushion forward.

◆ Installing child restraint system using a seat belt

Install the child restraint system in accordance to the operation manual enclosed with the child restraint system.

1

▶ Front seat

Adjust the seatback angle to the most upright position. Move the front seat fully rearward. (→P. 186)

When it is unavoidable to install a rear-facing child restraint system on the front passenger seat, a child restraint system can be installed if the PASSENGER AIRBAG OFF indicator lamp is lit.

If the head restraint interferes with your child restraint system, and the head restraint can be removed, remove the head restraint. Otherwise, put the head restraint in the upper most position. (→P. 191)

▶ Rear seat

If the head restraint interferes with your child restraint system, and the head restraint can be removed, remove the head restraint. Otherwise, put the head restraint in the upper most position. (→P. 191)

2 Run the seat belt through the child restraint system and insert the plate into the buckle. Make sure that the belt is not twisted. Securely fix the seat belt to the child restraint system in accordance to the directions enclosed with the child restraint system.

3 If your child restraint system is not equipped with a lock-off (a seat belt locking feature), secure the child restraint system using a locking clip.

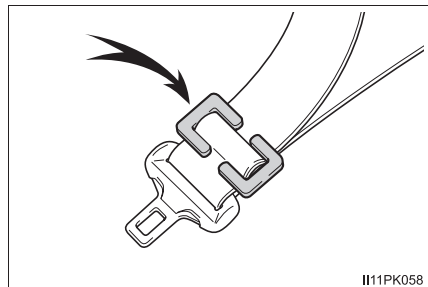

II11PK058

4 After installing the child restraint system, rock it back and forth to ensure that it is installed securely. (→P. 81)

◆ Removing a child restraint system installed with a seat belt

Press the buckle release button and fully retract the seat belt.

When releasing the buckle, the child restraint system may spring up due to the rebound of the seat cushion. Release the buckle while holding down the child restraint system.

Since the seat belt automatically reels itself, slowly return it to the stowing position.

■ When installing a child restraint system

You may need a locking clip to install the child restraint system. Follow the instructions provided by the manufacturer of the system. If your child restraint system does not provide a locking clip, you can purchase the following item from any authorized Toyota dealer or repairer, or another duly qualified and equipped professional: Locking clip for child restraint system (Part No. 73119-22010)

■ When removing the head restraint to install a child restraint system

After removing the child restraint system, make sure to reinstall the head restraint.



WARNING

■ When installing a child restraint system

Observe the following precautions.

Failure to do so may result in death or serious injury. تلفن

- Do not allow children to play with the seat belt. If the seat belt becomes twisted around a child's neck, it may lead to choking or other serious injuries that could result in death. If this occurs and the buckle cannot be unfastened, scissors should be used to cut the belt.
- Ensure that the belt and plate are securely locked and the seat belt is not twisted.
- Shake the child restraint system left and right, and forward and backward to ensure that it has been securely installed.
- After securing a child restraint system, never adjust the seat.
- When a junior seat is installed, always ensure that the shoulder belt is positioned across the center of the child's shoulder. The belt should be kept away from the child's neck, but not so that it could fall off the child's shoulder.
- Follow all installation instructions provided by the child restraint system manufacturer.

Child restraint system fixed with a seat belt (for Kazakhstan)

■ Child restraint system compatibility for various seating positions

The child restraint system suitability table (→P. 82), with symbols, displays the types of usable child restraint systems and possible seating position installation for the child restraint system owned by the customer. Confirm also in accordance with [Confirming the possible installation seating positions and the Mass Group for the seat belt installation type child restraint systems].

◆ Confirming the possible installation seating positions and the Mass Group for the seat belt installation type child restraint systems

- 1 Confirm the corresponding [Mass group] from the weight of the child (→P. 68)
(Ex. 1) When the weight is 12 kg, [Mass group 0+]
(Ex. 2) When the weight is 15 kg, [Mass group I]
- 2 Confirm and select the appropriate possible seating position for the child restraint system and the corresponding type of system from the [Child restraint systems fastened with SEAT BELT - Compatibility table]. (→P. 82)

◆ Child restraint systems fastened with SEAT BELT - Compatibility table

If your child restraint system is of “universal” category, you can install it on the positions mentioned by U or UF in the table below (UF is for forward-facing child restraint systems only). Child restraint systems category and mass group can be found in the child restraint system manual.

If your child restraint system is not of the “universal” category (or if you cannot find information in the table below), please refer to the child restraint system “vehicle list” for compatibility information or ask the retailer of your child seat.

► Single-cab models

Mass groups	Seating position
	Front passenger seat
0 Up to 10 kg (22 lb.)	X
0+ Up to 13 kg (28 lb.)	X
I 9 to 18 kg (20 to 39 lb.)	Rearward-facing — X
	Forward-facing — UF*1, 2
II, III 15 to 36 kg (34 to 79 lb.)	UF*1, 2

Key of letters inserted in the above table:

X: Not suitable seat position for children in this mass group.

U: Suitable for “universal” category child restraint systems approved for use in this mass group.

UF: Suitable for forward-facing “universal” category child restraint systems approved for use in this mass group.

*1: Adjust the seatback angle to the most upright position. Move the front seat fully rearward. If the passenger seat height can be adjusted, move it to the upper most position.

*2: If the head restraint interferes with your child restraint system, and the head restraint can be removed, remove the head restraint. Otherwise, put the head restraint in the upper most position.

► Smart-cab models

Mass groups	Seating position	
	Front passenger seat	Rear seat
0 Up to 10 kg (22 lb.)	X	X
0+ Up to 13 kg (28 lb.)	X	X
I 9 to 18 kg (20 to 39 lb.)	Rearward-facing — X	X
	Forward-facing — UF*1, 2	
II, III 15 to 36 kg (34 to 79 lb.)	UF*1, 2	X

Key of letters inserted in the above table:

X: Not suitable seat position for children in this mass group.

U: Suitable for “universal” category child restraint systems approved for use in this mass group.

UF: Suitable for forward-facing “universal” category child restraint systems approved for use in this mass group.

*1: Adjust the seatback angle to the most upright position. Move the front seat fully rearward. If the passenger seat height can be adjusted, move it to the upper most position.

*2: If the head restraint interferes with your child restraint system, and the head restraint can be removed, remove the head restraint. Otherwise, put the head restraint in the upper most position.

► Double-cab models

Mass groups	Seating position		
	Front passenger seat	Rear seat	
		Outboard	Center
0 Up to 10 kg (22 lb.)	X	U	X
0+ Up to 13 kg (28 lb.)	X	U	X
I 9 to 18 kg (20 to 39 lb.)	Rearward-facing — X	U*2	X
	Forward-facing — UF*1, 2		
II, III 15 to 36 kg (34 to 79 lb.)	UF*1, 2	U*2	X

Key of letters inserted in the above table: تلفن شبانه روز: 02125555555

X: Not suitable seat position for children in this mass group.

U: Suitable for “universal” category child restraint systems approved for use in this mass group.

UF: Suitable for forward-facing “universal” category child restraint systems approved for use in this mass group.

*1: Adjust the seatback angle to the most upright position. Move the front seat fully rearward. If the passenger seat height can be adjusted, move it to the upper most position.

*2: If the head restraint interferes with your child restraint system, and the head restraint can be removed, remove the head restraint. Otherwise, put the head restraint in the upper most position.

Double-cab models: When securing some types of child restraint systems in rear seat, it may not be possible to properly use the seat belts in positions next to the child restraint without interfering with it or affecting seat belt effectiveness. Be sure your seat belt fits snugly across your shoulder and low on your hips. If it does not, or if it interferes with the child restraint, move to a different position. Failure to do so may result in death or serious injury.

◆ Installing child restraint system using a seat belt

Install the child restraint system in accordance to the operation manual enclosed with the child restraint system.

1 Front seat:

Adjust the seatback angle to the most upright position. Move the front seat fully rearward. (→P. 186)

If the head restraint interferes with your child restraint system, and the head restraint can be removed, remove the head restraint. Otherwise, put the head restraint in the upper most position. (→P. 191)

Rear seat:

If the head restraint interferes with your child restraint system, and the head restraint can be removed, remove the head restraint. Otherwise, put the head restraint in the upper most position. (→P. 191)

- 2 Run the seat belt through the child restraint system and insert the plate into the buckle. Make sure that the belt is not twisted. Securely fix the seat belt to the child restraint system in accordance to the directions enclosed with the child restraint system.

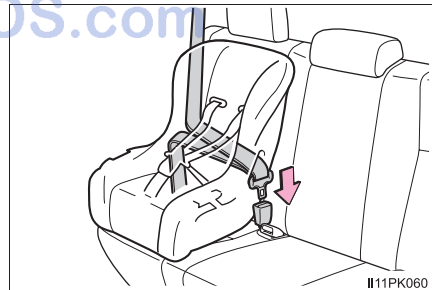

- 3 If your child restraint system is not equipped with a lock-off (a seat belt locking feature), secure the child restraint system using a locking clip.

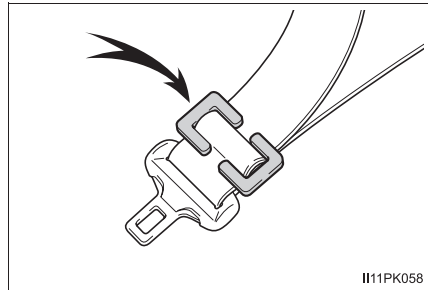

- 4 After installing the child restraint system, rock it back and forth to ensure that it is installed securely. (→P. 88)

◆ Removing a child restraint system installed with a seat belt

Press the buckle release button and fully retract the seat belt.

When releasing the buckle, the child restraint system may spring up due to the rebound of the seat cushion. Release the buckle while holding down the child restraint system.

Since the seat belt automatically reels itself, slowly return it to the stowing position.

■ When installing a child restraint system

You may need a locking clip to install the child restraint system. Follow the instructions provided by the manufacturer of the system. If your child restraint system does not provide a locking clip, you can purchase the following item from any authorized Toyota dealer or repairer, or another duly qualified and equipped professional: Locking clip for child restraint system (Part No. 73119-22010)

■ When removing the head restraint to install a child restraint system

After removing the child restraint system, make sure to reinstall the head restraint.

 **WARNING****■ When installing a child restraint system**

Observe the following precautions.

Failure to do so may result in death or serious injury.

- Do not allow children to play with the seat belt. If the seat belt becomes twisted around a child's neck, it may lead to choking or other serious injuries that could result in death. If this occurs and the buckle cannot be unfastened, scissors should be used to cut the belt.
- Ensure that the belt and plate are securely locked and the seat belt is not twisted.
- Shake the child restraint system left and right, and forward and backward to ensure that it has been securely installed.
- After securing a child restraint system, never adjust the seat.
- When a junior seat is installed, always ensure that the shoulder belt is positioned across the center of the child's shoulder. The belt should be kept away from the child's neck, but not so that it could fall off the child's shoulder.
- Follow all installation instructions provided by the child restraint system manufacturer.

تلفن شبانه روزی: ۰۲۱-۸۸۸۶۲۰۸۵

FarmaSOS.com

Child restraint system fixed with an ISOFIX rigid anchor (if equipped except for Kazakhstan)

■ ISOFIX rigid anchors (ISOFIX child restraint system)

Lower anchors are provided for the outboard rear seats. (Tags displaying the location of the anchors are attached to the seats.)



امداد خودرو فارما

تلفن شبانه روزی: ۰۲۱-۸۸۸۶۲۰۸۵

FarmaSOS.com

■ Confirming the Mass group and Size class for ECE R44 ISOFIX corresponding child restraint systems

1 Confirm the corresponding [Mass group] from the weight of the child (→P. 68)

(Ex. 1) When the weight is 12 kg, [Mass group 0+]

(Ex. 2) When the weight is 15 kg, [Mass group I]

2 Confirming Size class

Select the Size class corresponding to [Mass group] confirmed in step 1 from the [Child restraint systems fastened with ISOFIX (ECE R44) - Compatibility and Recommended child restraint systems table] (→P. 91)*.

(Ex. 1) When [Mass group 0+], the corresponding size class is [C], [D], [E].

(Ex. 2) When [Mass group I], the corresponding size class is [A], [B], [B1], [C], [D].

*: However, listings that are marked with [X] can not be selected, despite having the corresponding size class in the suitability table of the [Seating position]. Also, select the product designated by [Recommended Child Restraint Systems] (→P. 92), if the listing is marked with [IL].

تلفن شبانه روزی: ۰۲۱-۸۸۸۶۲۰۸۵

FarmaSOS.com

■ Child restraint systems fastened with ISOFIX (ECE R44) - Compatibility and Recommended child restraint systems table

ISOFIX child restraint systems are divided in different “size class”. According to this “size class”, you will be allowed to use it in the vehicle seating position mentioned in the table below. To know your child restraint system “size class” and “mass group”, please refer to the child restraint system manual.

If your child restraint system has no “size class” (or if you cannot find information in the table below), please refer to the child restraint system “vehicle list” for compatibility information or ask the retailer of your child seat.

Size class	Description
A	Full-height, forward-facing child restraint systems
B	Reduced-height forward-facing child restraint systems
B1	Reduced-height forward-facing child restraint systems
C	Full-size rearward-facing child restraint systems
D	Reduced-size rearward-facing child restraint systems
E	Rearward-facing infant seat
F	Left lateral-facing (carrycot) infant seat
G	Right lateral-facing (carrycot) infant seat

FarmaSOS.com

► Double-cab models

Mass groups	Size class	Seating position			Recommended Child Restraint Systems
		Front seat	Rear seat		
		Passenger seat	Outboard	Center	
Carrycot	F	X	X	X	-
	G	X	X	X	
0 Up to 10 kg (22 lb.)	E	X	IL	X	"TOYOTA MINI" "TOYOTA MIDI"
0+ Up to 13 kg (28 lb.)	E	X	IL	X	
	D	X	IL	X	
I 9 to 18 kg (20 to 39 lb.)	C	X	IL	X	-
	D	X	IL	X	
	B	X	IUF* IL*	X	"TOYOTA MIDI"
	B1	X	IUF* IL*	X	"TOYOTA DUO+" "TOYOTA MIDI"
	A	X	IUF* IL*	X	"TOYOTA MIDI"

Key of letters inserted in the above table:

X: Not suitable seat position for ISOFIX child restraint systems in this mass group and/or size class.

IUF: Suitable for ISOFIX forward-facing child restraint systems of “universal” category approved for use in this mass group.

IL: Suitable for ISOFIX child restraint systems of the categories for “specific vehicles”, “restricted”, or “semi-universal” approved for use in this mass group.

*: If the head restraint interferes with your child restraint system, and the head restraint can be removed, remove the head restraint. Otherwise, put the head restraint in the upper most position.

When securing some types of child restraint systems in rear seat, it may not be possible to properly use the seat belts in positions next to the child restraint without interfering with it or affecting seat belt effectiveness. Be sure your seat belt fits snugly across your shoulder and low on your hips. If it does not, or if it interferes with the child restraint, move to a different position. Failure to do so may result in death or serious injury.

The child restraint systems mentioned in the table may not be available outside the EU area.

- When installing a child restraint in the rear seats, adjust the front seat so that it does not interfere with the child or child restraint system.
- When using a “TOYOTA MINI” or “TOYOTA MIDI”, adjust the support leg and ISOFIX connectors as follows:

- ① Lock the ISOFIX connectors where number 3 can be seen.
- ② Lock the support leg where 6 holes can be seen.

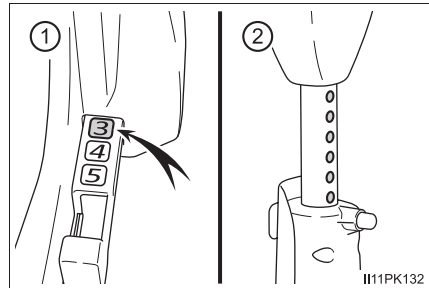

■ i-Size child restraint systems fastened with ISOFIX (ECE R129) - Compatibility table

If your child restraint system is of “i-Size” category, you can install it on the positions mentioned by i-U in the table below.

Child restraint system category can be found in the child restraint system manual.

► Double-cab models

	Seating position		
	Front seat	Rear seat	
	Passenger seat	Outboard	Center
i-Size child restraint systems	X	i-U*	X

Key of letters inserted in the above table:

X: Not suitable for use with i-Size child restraint systems.

i-U: Suitable for i-Size “universal” child restraint systems forward and rearward facing.

*: If the head restraint interferes with your child restraint system, and the head restraint can be removed, remove the head restraint. Otherwise, put the head restraint in the upper most position. تلفن شبانه ۰۲۱۸۸۸۰۸۸۸

When securing some types of child restraint systems in rear seat, it may not be possible to properly use the seat belts in positions next to the child restraint without interfering with it or affecting seat belt effectiveness. Be sure your seat belt fits snugly across your shoulder and low on your hips. If it does not, or if it interferes with the child restraint, move to a different position. Failure to do so may result in death or serious injury.

● When installing a child restraint in the rear seats, adjust the front seat so that it does not interfere with the child or child restraint system.

■ Installation with ISOFIX rigid anchor (ISOFIX child restraint system)

Install the child restraint system in accordance to the operation manual enclosed with the child restraint system.

- 1 If the head restraint interferes with your child restraint system, and the head restraint can be removed, remove the head restraint. Otherwise, put the head restraint in the upper most position. (→P. 191)
- 2 Check the positions of the exclusive fixing bars, and install the child restraint system to the seat.

The bars are installed in the clearance between the seat cushion and seatback.



- 3 After installing the child restraint system, rock it back and forth to ensure that it is installed securely. (→P. 81)

■ When removing the head restraint to install a child restraint system

After removing the child restraint system, make sure to reinstall the head restraint.

**WARNING****■ When installing a child restraint system**

Observe the following precautions.

Failure to do so may result in death or serious injury.

- After securing a child restraint system, never adjust the seat.
- When using the lower anchors, be sure that there are no foreign objects around the anchors and that the seat belt is not caught behind the child restraint system.
- Follow all installation instructions provided by the child restraint system manufacturer.

امداد خودرو فارما

تلفن شبانه روزی: ۰۲۱-۸۸۸۶۲۰۸۵

FarmaSOS.com

Child restraint system fixed with an ISOFIX rigid anchor (for Kazakhstan)

■ ISOFIX rigid anchors (ISOFIX child restraint system)

Lower anchors are provided for the outboard rear seats. (Tags displaying the location of the anchors are attached to the seats.)



■ Child restraint system compatibility for various seating positions

The child restraint system compatibility table (→P. 99), with symbols, displays the types of usable child restraint systems and possible seating position installation for the child restraint system owned by the customer. Confirm in accordance with the listed Size class, Anchor, as well as [Confirming the Mass group and Size class for ECE R44 ISOFIX corresponding child restraint systems].

■ Confirming the Mass group and Size class for ECE R44 ISOFIX corresponding child restraint systems

1 Confirm the corresponding [Mass group] from the weight of the child (→P. 68)

(Ex. 1) When the weight is 12 kg, [Mass group 0+]

(Ex. 2) When the weight is 15 kg, [Mass group I]

2 Confirming Size class

Select the Size class corresponding to [Mass group] confirmed in step 1 from the [Child restraint systems fastened with ISOFIX (ECE R44) - Compatibility table] (→P. 99)*.

(Ex. 1) When [Mass group 0+], the corresponding size class is [C], [D], [E].

(Ex. 2) When [Mass group I], the corresponding size class is [A], [B], [B1], [C], [D].

*: However, listings that are marked with [X] can not be selected, despite having the corresponding size class in the suitability table of the [Seating position].

تلفن شبانه روزی: ۰۲۱-۸۸۸۶۲۰۸۵

FarmaSOS.com

■ Child restraint systems fastened with ISOFIX (ECE R44) - Compatibility table

ISOFIX child restraint systems are divided in different “size class”. According to this “size class”, you will be allowed to use it in the vehicle seating position mentioned in the table below. To know your child restraint system “size class” and “mass group”, please refer to the child restraint system manual.

If your child restraint system has no “size class” (or if you cannot find information in the table below), please refer to the child restraint system “vehicle list” for compatibility information or ask the retailer of your child seat.

Size class	Description
A	Full-height, forward-facing child restraint systems
B	Reduced-height forward-facing child restraint systems
B1	Reduced-height forward-facing child restraint systems
C	Full-size rearward-facing child restraint systems
D	Reduced-size rearward-facing child restraint systems
E	Rearward-facing infant seat
F	Left lateral-facing (carrycot) infant seat
G	Right lateral-facing (carrycot) infant seat

FarmaSOS.com

► Double-cab models

Mass groups	Size class	Seating position		
		Front seat	Rear seat	
		Passenger seat	Outboard	Center
Carrycot	F	X	X	X
	G	X	X	X
0 Up to 10 kg (22 lb.)	E	X	IL	X
0+ Up to 13 kg (28 lb.)	E	X	IL	X
	D	X	IL	X
	C	X	IL	X
I 9 to 18 kg (20 to 39 lb.)	D	X	IL	X
	C	X	IL	X
	B	X	IUF*	X
	B1	X	IUF*	X
	A	X	IUF*	X

Key of letters inserted in the above table:

X: Not suitable seat position for ISOFIX child restraint systems in this mass group and/or size class.

IUF: Suitable for ISOFIX forward-facing child restraint systems of “universal” category approved for use in this mass group.

IL: Suitable for ISOFIX child restraint systems of the categories for “specific vehicles”, “restricted”, or “semi-universal” approved for use in this mass group.

*: If the head restraint interferes with your child restraint system, and the head restraint can be removed, remove the head restraint. Otherwise, put the head restraint in the upper most position.

When securing some types of child restraint systems in rear seat, it may not be possible to properly use the seat belts in positions next to the child restraint without interfering with it or affecting seat belt effectiveness. Be sure your seat belt fits snugly across your shoulder and low on your hips. If it does not, or if it interferes with the child restraint, move to a different position. Failure to do so may result in death or serious injury.

■ i-Size child restraint systems fastened with ISOFIX (ECE R129) - Compatibility table

If your child restraint system is of “i-Size” category, you can install it on the positions mentioned by i-U in the table below.

Child restraint system category can be found in the child restraint system manual.

▶ Double-cab models

	Seating position		
	Front seat	Rear seat	
	Passenger seat	Outboard	Center
i-Size child restraint systems	X	i-U*	X

Key of letters inserted in the above table:

X: Not suitable for use with i-Size child restraint systems.

i-U: Suitable for i-Size “universal” child restraint systems forward and rearward facing.

*: If the head restraint interferes with your child restraint system, and the head restraint can be removed, remove the head restraint. Otherwise, put the head restraint in the upper most position.

When securing some types of child restraint systems in rear seat, it may not be possible to properly use the seat belts in positions next to the child restraint without interfering with it or affecting seat belt effectiveness. Be sure your seat belt fits snugly across your shoulder and low on your hips. If it does not, or if it interferes with the child restraint, move to a different position. Failure to do so may result in death or serious injury.

- When installing a child restraint in the rear seats, adjust the front seat so that it does not interfere with the child or child restraint system.

■ Installation with ISOFIX rigid anchor (ISOFIX child restraint system)

Install the child restraint system in accordance to the operation manual enclosed with the child restraint system.

- 1 If the head restraint interferes with your child restraint system, and the head restraint can be removed, remove the head restraint. Otherwise, put the head restraint in the upper most position. (→P. 191)
- 2 Check the positions of the exclusive fixing bars, and install the child restraint system to the seat.

The bars are installed in the clearance between the seat cushion and seatback.



- 3 After installing the child restraint system, rock it back and forth to ensure that it is installed securely. (→P. 88)

■ When removing the head restraint to install a child restraint system

After removing the child restraint system, make sure to reinstall the head restraint.

⚠ WARNING**■ When installing a child restraint system**

Observe the following precautions.

Failure to do so may result in death or serious injury.

- After securing a child restraint system, never adjust the seat.
- When using the lower anchors, be sure that there are no foreign objects around the anchors and that the seat belt is not caught behind the child restraint system.
- Follow all installation instructions provided by the child restraint system manufacturer.

امداد خودرو فارما

تلفن شبانه روزی: ۰۲۱-۸۸۸۶۲۰۸۵

FarmaSOS.com

Using an anchor bracket (for top strap) (if equipped)

■ Anchor bracket (for top strap)

Anchor bracket are provided for the outboard rear seat.

Use anchor bracket when fixing the top strap.

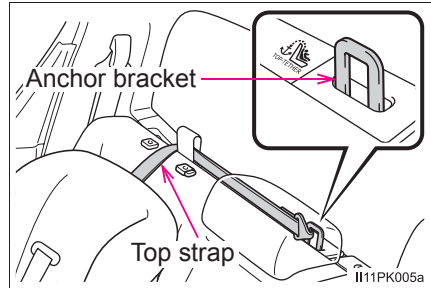

■ Fixing the top strap to the anchor bracket

Install the child restraint system in accordance to the operation manual enclosed with the child restraint system.

- 1 Remove the head restraint.

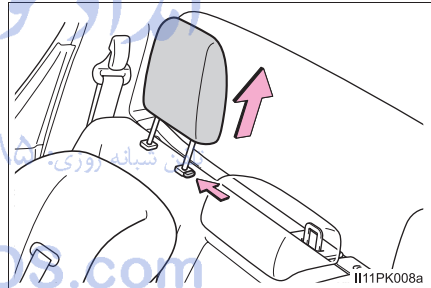

- 2 Pull up the anchor strap router.

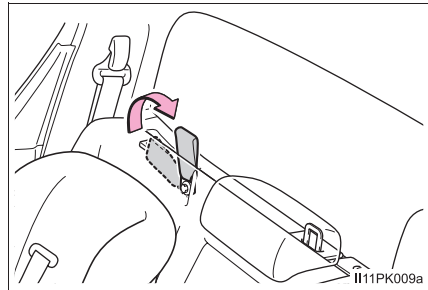

- 3 Route the top strap through the anchor strap router as shown in the illustration.

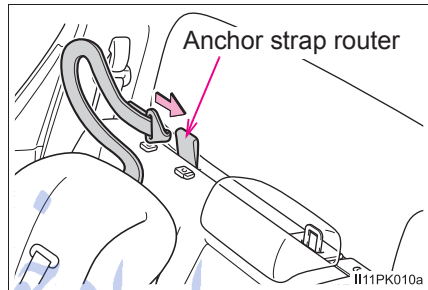

- 4 Latch the hook onto the anchor bracket and tighten the top strap.

Make sure the top strap is securely latched. (→P. 81)

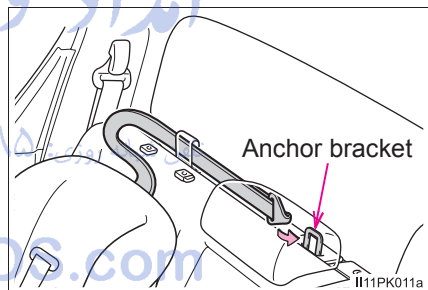

■ **When removing the head restraint to install a child restraint system**

After removing the child restraint system, make sure to reinstall the head restraint.

 WARNING**■ When installing a child restraint system**

Observe the following precautions.

Failure to do so may result in death or serious injury.

- Firmly attach the top strap.
- Do not attach the top strap to anything other than the anchor bracket.
- After securing a child restraint system, never adjust the seat.
- Follow all installation instructions provided by the child restraint system manufacturer.
- When installing the child restraint system, do not install the head restraint.

امداد خودرو فارما

تلفن شبانه روزی: ۰۲۱-۸۸۸۶۲۰۸۵

FarmaSOS.com

Engine immobilizer system*

The vehicle's keys have built-in transponder chips that prevent the engine from starting if a key has not been previously registered in the vehicle's on-board computer.

Never leave the keys inside the vehicle when you leave the vehicle.

This system is designed to help prevent vehicle theft but does not guarantee absolute security against all vehicle thefts.

Vehicles without smart entry & start system:

The indicator light flashes after the key has been removed from the engine switch to indicate that the system is operating.

The indicator light stops flashing after the registered key has been inserted into the engine switch to indicate that the system has been canceled.

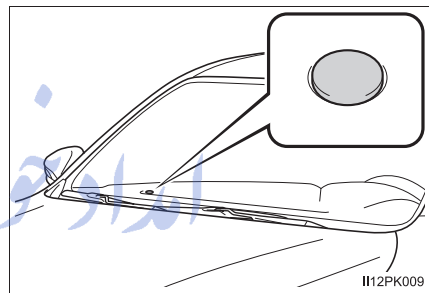

FarmaSOS.com

*: If equipped

Vehicles with smart entry & start system:

The indicator light flashes after the engine switch has been turned off to indicate that the system is operating.

The indicator light stops flashing after the engine switch has been turned to ACCESSORY or IGNITION ON mode to indicate that the system has been canceled.

■ **System maintenance**

The vehicle has a maintenance-free type engine immobilizer system.

■ **Conditions that may cause the system to malfunction**

- If the grip portion of the key is in contact with a metallic object
- If the key is in close proximity to or touching a key to the security system (key with a built-in transponder chip) of another vehicle

امداد خودرو فارما

تلفن شبانه روزی: ۰۲۱-۸۸۸۶۲۰۸۵

FarmaSOS.com

■ Certification for the engine immobilizer system

► Vehicles without smart entry & start system

<p>Hereby, Tokai Rika Co., Ltd., declares that this RI-42BTY is in compliance with the essential requirements and other relevant provisions of Directive 1999/5/EC.</p>
<p>Tokai Rika Co., Ltd. vakuuttaa täten että RI-42BTY tyyppinen laite on direktiivin 1999/5/EY oleellisten vaatimusten ja sitä koskevien direktiivin muiden ehtojen mukainen.</p>
<p>Hierbij verklaart Tokai Rika Co., Ltd. dat het toestel RI-42BTY in overeenstemming is met de essentiële eisen en de andere relevante bepalingen van richtlijn 1999/5/EG.</p>
<p>Par la présente Tokai Rika Co., Ltd. déclare que l'appareil RI-42BTY est conforme aux exigences essentielles et aux autres dispositions pertinentes de la directive 1999/5/CE.</p>
<p>Härmed intygar Tokai Rika Co., Ltd. att denna RI-42BTY står i överensstämmelse med de väsentliga egenskapskrav och övriga relevanta bestämmelser som framgår av direktiv 1999/5/EG.</p>
<p>Undertegnede Tokai Rika Co., Ltd. erklærer herved, at følgende udstyr RI-42BTY overholder de væsentlige krav og øvrige relevante krav i direktiv 1999/5/EF.</p>
<p>Hiermit erklärt Tokai Rika Co., Ltd., dass sich das Gerät RI-42BTY in Übereinstimmung mit den grundlegenden Anforderungen und den übrigen einschlägigen Bestimmungen der Richtlinie 1999/5/EG befindet.</p>
<p>ΜΕ ΤΗΝ ΠΑΡΟΥΣΑ Tokai Rika Co., Ltd. ΔΗΛΩΝΕΙ ΟΤΙ RI-42BTY ΣΥΜΜΟΡΦΩΝΕΤΑΙ ΠΡΟΣ ΤΙΣ ΟΥΣΙΩΔΕΙΣ ΑΠΑΙΤΗΣΕΙΣ ΚΑΙ ΤΙΣ ΛΟΙΠΕΣ ΣΧΕΤΙΚΕΣ ΔΙΑΤΑΞΕΙΣ ΤΗΣ ΟΔΗΓΙΑΣ 1999/5/ΕΚ.</p>
<p>Con la presente Tokai Rika Co., Ltd. dichiara che questo RI-42BTY è conforme ai requisiti essenziali ed alle altre disposizioni pertinenti stabilite dalla direttiva 1999/5/CE.</p>
<p>Por medio de la presente Tokai Rika Co., Ltd. declara que el RI-42BTY cumple con los requisitos esenciales y cualesquiera otras disposiciones aplicables o exigibles de la Directiva 1999/5/CE.</p>
<p>Tokai Rika Co., Ltd. declara que este RI-42BTY está conforme com os requisitos essenciais e outras disposições da Directiva 1999/5/CE.</p>

Hawnhekk, Tokai Rika Co., Ltd., jiddikjara li dan RI-42BTY jikkonforma mal-ħtiġijiet essenzjali u ma provvedimenti oħrajn relevanti li hemm fid-Dirrettiva 1999/5/EC.

Käesolevaga kinnitab Tokai Rika Co., Ltd. seadme RI-42BTY vastavust direktiivi 1999/5/EÜ pöhinöuetele ja nimetatud direktiivist tulenevatele teistele asjakohastele sätetele.

Alulírott, Tokai Rika Co., Ltd. nyilatkozom, hogy a RI-42BTY megfelel a vonatkozó alapvető követelményeknek és az 1999/5/EC irányelv egyéb előírásainak.

Tokai Rika Co., Ltd. týmto vyhlasuje, že RI-42BTY spĺňa základné požiadavky a všetky príslušné ustanovenia Smernice 1999/5/ES.

Tokai Rika Co., Ltd. tímto prohlašuje, že tento RI-42BTY je ve shodě se základními požadavky a dalšími příslušnými ustanoveními směrnice 1999/5/ES.

Tokai Rika Co., Ltd. izjavlja, da je ta RI-42BTY v skladu z bistvenimi zahtevami in ostalimi relevantnimi določili direktive 1999/5/ES.

Šiuo Tokai Rika Co., Ltd. deklaruoja, kad šis RI-42BTY atitinka esminius reikalavimus ir kitas 1999/5/EB Direktyvos nuostatas.

Ar šo Tokai Rika Co., Ltd. deklarē, ka RI-42BTY atbilst Direktīvas 1999/5/EK būtiskajām prasībām un citiem ar to saistītajiem noteikumiem.

Niniejszym Tokai Rika Co., Ltd. oświadcza, że RI-42BTY jest zgodny z zasadniczymi wymogami oraz pozostałymi stosownymi postanowieniami Dyrektywy 1999/5/EC.

Hér með lýsir Tokai Rika Co., Ltd. yfir því að RI-42BTY er í samræmi við grunnkröfur og aðrar kröfur, sem gerðar eru í tilskipun 1999/5/EC.

Tokai Rika Co., Ltd. erklærer herved at utstyret RI-42BTY er i samsvar med de grunnleggende krav og øvrige relevante krav i direktiv 1999/5/EF.

С настоящето, Tokai Rika Co., Ltd., декларира, че RI-42BTY е в съответствие със съществените изисквания и другите приложими разпоредби на Директива 1999/5/EC.

Prin prezenta, Tokai Rika Co., Ltd., declară că aparatul RI-42BTY este în conformitate cu cerințele esențiale și cu alte prevederi pertinente ale Directivei 1999/5/CE.

Ovim, Tokai Rika Co., Ltd., izjavljuje da ovaj RI-42BTY je usklađen sa bitnim zahtjevima i drugim relevantnim odredbama Direktive 1999/5/EC.

Nepermjet kesaj, Tokai Rika Co., Ltd., deklaroi qe ky RI-42BTY eshte ne pajtim me kerkesat thelbesore dhe dispozitat e tjera perkatese te Direktives 1999/5/EC.

Ovim Tokai Rika Co., Ltd., izjavljuje da je RI-42BTY u skladu s bitnim zahtjevima i drugim relevantnim odredbama Direktive 1999/5/EC i Pravilnika o RiTT opremi (NN 25/2012).

Ovim, Tokai Rika Co., Ltd., deklarirše da je RI-42BTY u skladu sa osnovnim zahtevima i ostalim relevantnim odredbama Direktive 1999/5/EC.

The DECLARATION of CONFORMITY (DoC) is available at the following address:

<http://www.tokai-rika.co.jp/pc>



تلفن شبانه روزی: ۰۲۱-۸۸۸۶۲۰۸۵

FarmaSOS.com

► Vehicles with smart entry & start system

TOYOTA**TOYOTA MOTOR CORPORATION**

1, TOYOTA-CHO, TOYOTA, AICHI, 471-8571, JAPAN TEL: +81-565-28-2121

R&TTE Declaration of Conformity

We,

Manufacturer's Name: TOYOTA MOTOR CORPORATION

Manufacturer's Address: 1, Toyota -cho, Toyota, Aichi, 471-8572, Japan

hereby declare under our sole responsibility that the product:

Product Name: Immobilizer

Product Model: TMIMB-3

to which this declaration relates is in conformity with the essential requirements and other relevant requirements of the R&TTE Directive (1999/5/EC). The product is compliant with the following standards and/or other normative documents:

- تلفن شبانه روزی: ۰۲۱-۸۸۶۲۰۸۸
- Health & safety requirements: EN 60950-1
 - EMC requirements: EN 301 489-01 & EN 301 489-03
 - Effective uses of radio spectrum: EN 300 330-2

Supplementary information:

* CE mark	
* Member states intended for use	EU and EFTA

Date: February 25, 2013

Signature:



Tetsuya Matsuo

Hereby, Toyota Motor Corporation, declares that this TMIMB-3 is in compliance with the essential requirements and other relevant provisions of Directive 1999/5/EC.
Toyota Motor Corporation vakuuttaa täten että TMIMB-3 tyyppinen laite on direktiivin 1999/5/EY oleellisten vaatimusten ja sitä koskevien direktiivin muiden ehtojen mukainen.
Hierbij verklaart Toyota Motor Corporation dat het toestel TMIMB-3 in overeenstemming is met de essentiële eisen en de andere relevante bepalingen van richtlijn 1999/5/EG.
Par la présente Toyota Motor Corporation déclare que l'appareil TMIMB-3 est conforme aux exigences essentielles et aux autres dispositions pertinentes de la directive 1999/5/CE.
Härmed intygar Toyota Motor Corporation att denna TMIMB-3 står i överensstämmelse med de väsentliga egenskapskrav och övriga relevanta bestämmelser som framgår av direktiv 1999/5/EG.
Undertegnede Toyota Motor Corporation erklærer herved, at følgende udstyr TMIMB-3 overholder de væsentlige krav og øvrige relevante krav i direktiv 1999/5/EF.
Hiermit erklärt Toyota Motor Corporation, dass sich das Gerät TMIMB-3 in Übereinstimmung mit den grundlegenden Anforderungen und den übrigen einschlägigen Bestimmungen der Richtlinie 1999/5/EG befindet.
ΜΕ ΤΗΝ ΠΑΡΟΥΣΑ Toyota Motor Corporation ΔΗΛΩΝΕΙ ΟΤΙ ΤΜΙΜΒ-3 ΣΥΜΜΟΡΦΟΝΕΤΑΙ ΠΡΟΣ ΤΙΣ ΟΥΣΙΩΔΕΙΣ ΑΠΑΙΤΗΣΕΙΣ ΚΑΙ ΤΙΣ ΛΟΙΠΕΣ ΣΧΕΤΙΚΕΣ ΔΙΑΤΑΞΕΙΣ ΤΗΣ ΟΔΗΓΙΑΣ 1999/5/ΕΚ.
Con la presente Toyota Motor Corporation dichiara che questo TMIMB-3 è conforme ai requisiti essenziali ed alle altre disposizioni pertinenti stabilite dalla direttiva 1999/5/CE.
Por medio de la presente Toyota Motor Corporation declara que el TMIMB-3 cumple con los requisitos esenciales y cualesquiera otras disposiciones aplicables o exigibles de la Directiva 1999/5/CE.
Toyota Motor Corporation declara que este TMIMB-3 está conforme com os requisitos essenciais e outras disposições da Directiva 1999/5/CE.

Hawnhekk, Toyota Motor Corporation, jiddikjara li dan TMIMB-3 jikkonforma mal-ħtiġijiet essenzjali u ma provvedimenti oħrajn relevanti li hemm fid-Dirrettiva 1999/5/EC.
Käesolevaga kinnitab Toyota Motor Corporation seadme TMIMB-3 vastavust direktiivi 1999/5/EÜ pöhinöuetele ja nimetatud direktiivist tulenevatele teistele asjakohastele sätetele.
Alulírott, Toyota Motor Corporation nyilatkozom, hogy a TMIMB-3 megfelel a vonatkozó alapvető követelményeknek és az 1999/5/EC irányelv egyéb előírásainak.
Toyota Motor Corporation týmto vyhlasuje, že TMIMB-3 spĺňa základné požiadavky a všetky príslušné ustanovenia Smernice 1999/5/ES.
Toyota Motor Corporation tímto prohlašuje, že tento TMIMB-3 je ve shodě se základními požadavky a dalšími příslušnými ustanoveními směrnice 1999/5/ES.
Toyota Motor Corporation izjavlja, da je ta TMIMB-3 v skladu z bistvenimi zahtevami in ostalimi relevantnimi določili direktive 1999/5/ES.
Šiuo Toyota Motor Corporation deklaruoja, kad šis TMIMB-3 atitinka esminius reikalavimus ir kitas 1999/5/EB Direktyvos nuostatas.
Ar šo Toyota Motor Corporation deklarē, ka TMIMB-3 atbilst Direktīvas 1999/5/EK būtiskajām prasībām un citiem ar to saistītajiem noteikumiem.
Niniejszym Toyota Motor Corporation oświadcza, że TMIMB-3 jest zgodny z zasadniczymi wymogami oraz pozostałymi stosownymi postanowieniami Dyrektywy 1999/5/EC.
Hér með lýsir Toyota Motor Corporation yfir því að TMIMB-3 er í samræmi við grunnkröfur og aðrar kröfur, sem gerðar eru í tilskipun 1999/5/EC.
Toyota Motor Corporation erklærer herved at utstyret TMIMB-3 er i samsvar med de grunnleggende krav og øvrige relevante krav i direktiv 1999/5/EF.
С настоящето, Toyota Motor Corporation, декларира, че TMIMB-3 е в съответствие със съществените изисквания и другите приложими разпоредби на Директива 1999/5/EC.

Prin prezenta, Toyota Motor Corporation, declară că aparatul TMIMB-3 este în conformitate cu cerințele esențiale și cu alte prevederi pertinente ale Directivei 1999/5/CE.
Ovim, Toyota Motor Corporation, izjavljuje da ovaj TMIMB-3 je usklađen sa bitnim zahtjevima i drugim relevantnim odredbama Direktive 1999/5/EC.
Nepermjet kesaj, Toyota Motor Corporation, deklaroi qe ky TMIMB-3 eshte ne pajtim me kerkesat thelbesore dhe dispozitat e tjera perkatese te Direktives 1999/5/EC.
Ovim Toyota Motor Corporation, izjavljuje da je TMIMB-3 u skladu s bitnim zahtjevima i drugim relevantnim odredbama Direktive 1999/5/EC i Pravilnika o RiTT opremi (NN 25/2012).
Ovim, Toyota Motor Corporation, deklariše da je TMIMB-3 u skladu sa osnovnim zahtevima i ostalim relevantnim odredbama Direktive 1999/5/EC.

 NOTICE

■ **To ensure the system operates correctly**

Do not modify or remove the system. If modified or removed, the proper operation of the system cannot be guaranteed.

تلفن شبانه روزی: ۰۸۵-۸۸۸۶۰۳۱

FarmaSOS.com

Alarm*

The alarm

The alarm uses light and sound to give an alert when an intrusion is detected.

The alarm is triggered in the following situations when the alarm is set:

- ▶ Except for Kazakhstan and Morocco
- A locked door is opened in any way other than using the entry function (vehicles with smart entry & start system), wireless remote control or mechanical key.
- The hood is opened.
- ▶ For Kazakhstan and Morocco
- A locked door is opened in any way other than using the entry function (vehicles with smart entry & start system) or wireless remote control.
- The hood is opened.

Setting the alarm system

Close the doors and hood, and lock all the doors using the entry function (vehicles with smart entry & start system) or wireless remote control. The system will be set automatically after 30 seconds.

Except for Kazakhstan and Morocco: The alarm can also be set using the mechanical key.

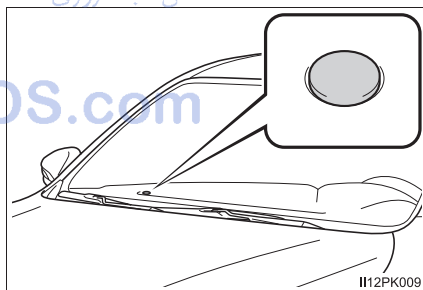

The indicator light changes from being on to flashing when the system is set.

*: If equipped

Deactivating or stopping the alarm

Do one of the following to deactivate or stop the alarms:

- ▶ Except for Kazakhstan and Morocco
 - Unlock the doors.
 - Start the engine. (The alarm will be deactivated or stopped after a few seconds.)
- ▶ For Kazakhstan and Morocco
 - Unlock the doors using the entry function (vehicles with smart entry & start system) or the wireless remote control.
 - Start the engine. (The alarm will be deactivated or stopped after a few seconds.)

■ System maintenance

The vehicle has a maintenance-free type alarm system.

■ Items to check before locking the vehicle

To prevent unexpected triggering of the alarm and vehicle theft, make sure of the following:

- Nobody is in the vehicle.
- The windows are closed before the alarm is set.
- No valuables or other personal items are left in the vehicle.

FarmaSOS.com

■ Triggering of the alarm

The alarm may be triggered in the following situations:
(Stopping the alarm deactivates the alarm system.)

- For Kazakhstan and Morocco: The doors are unlocked using the key and are opened.

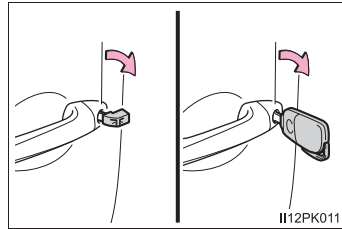

- A person inside the vehicle opens a door or hood.

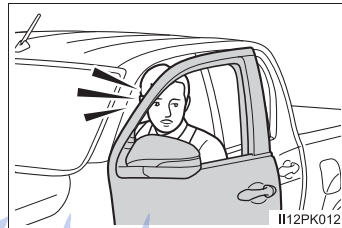

⚠ NOTICE

■ To ensure the system operates correctly

Do not modify or remove the system. If modified or removed, the proper operation of the system cannot be guaranteed.

Instrument cluster

2

2. Instrument cluster

Warning lights and indicators	120
Gauges and meters	128
Multi-information display (Type A).....	133
Multi-information display (Type B).....	136
Fuel consumption information.....	144

تلفن شبانه روزی: ۰۲۱-۸۸۸۶۲۰۸۵

FarmaSOS.com

Warning lights and indicators

The warning lights and indicators on the instrument cluster and center panel inform the driver of the status of the vehicle's various systems.

For the purpose of explanation, the following illustrations display all warning lights and indicators illuminated.

- Vehicles without multi-information display

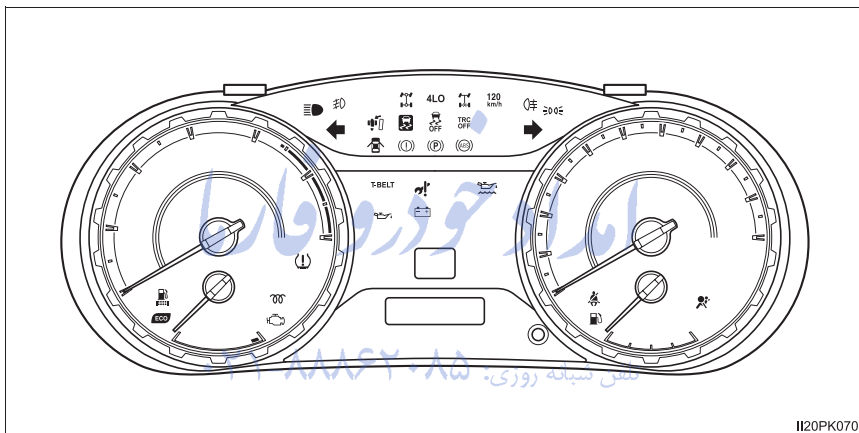

- Vehicles with multi-information display type A

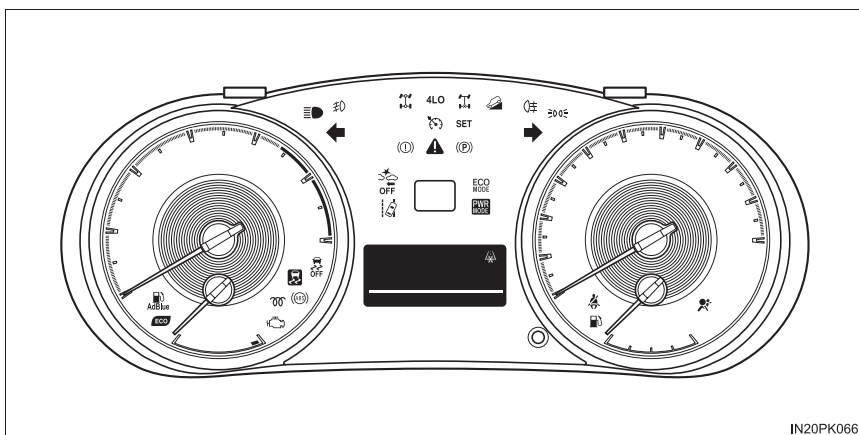

► Vehicles with multi-information display type B

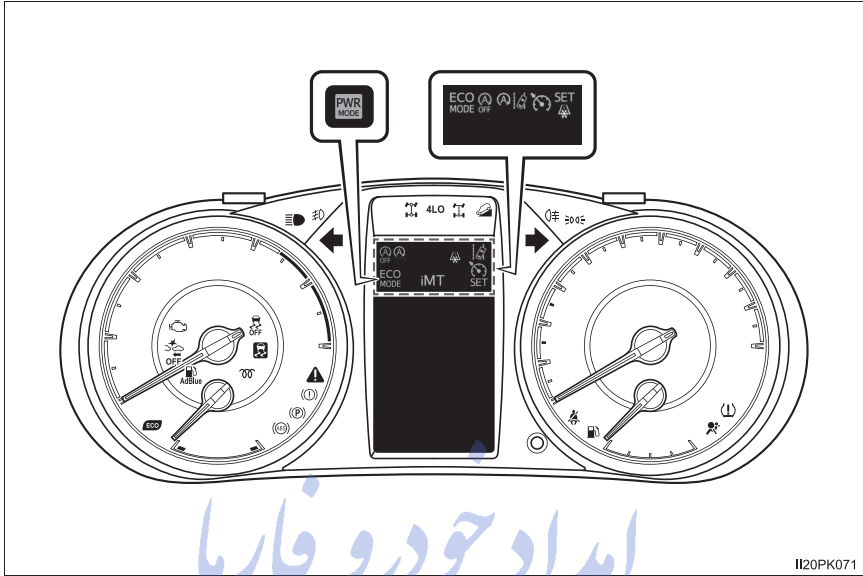

The positions of some warning lights and indicators differ depending on vehicles.

Warning lights

Warning lights inform the driver of malfunctions in the indicated vehicle's systems.



*1

Brake system warning light (→P. 567)



*1, 2

Malfunction indicator lamp (→P. 568)



*1

Charging system warning light (→P. 567)

(if equipped)



*1

SRS warning light (→P. 568)



*1



















Low engine oil pressure warning light (→P. 567)

(if equipped)



*1

ABS warning light (→P. 568)

<p>^{*1}</p>  <p>(if equipped)</p>	<p>Slip indicator light (→P. 568)</p>	 <p>(if equipped)</p>	<p>Open door warning light (→P. 571)</p>
<p>^{*3}</p>  <p>(if equipped)</p>	<p>Four-wheel drive indicator light (→P. 569)</p>		<p>Driver's and front passenger's seat belt reminder light (→P. 571)</p>
<p>^{*3}</p>  <p>(if equipped)</p>	<p>Low speed four-wheel drive indicator light (→P. 569)</p>	<p>^{*7}</p>  <p>(if equipped)</p>	<p>Rear passengers' seat belt reminder lights (→P. 571)</p>
<p>^{*3}</p>  <p>(if equipped)</p>	<p>Rear differential lock indicator light (→P. 569)</p>		<p>Low fuel level warning light (→P. 571)</p>
<p>^{*1}</p>  <p>(if equipped)</p>	<p>Timing belt replacement warning light (→P. 569)</p>	<p>^{*1}</p>  <p>(if equipped)</p>	<p>Low engine oil level warning light (→P. 571)</p>
<p>^{*1}</p>  <p>(if equipped)</p>	<p>Fuel system warning light (→P. 569)</p>	<p>^{*1}</p>  <p>(if equipped)</p>	<p>Master warning light (→P. 571)</p>
<p>^{*1, 4}</p>  <p>(if equipped)</p>	<p>Brake Override System warning light (→P. 570)</p>	<p>^{*1}</p>  <p>(if equipped)</p>	<p>Go to service warning light (→P. 574)</p>
<p>^{*1, 4}</p>  <p>(if equipped)</p>	<p>PCS warning light (→P. 570)</p>	<p>^{*1, 4}</p>  <p>(if equipped)</p>	<p>Stop & Start cancel indicator (→P. 572)</p>
<p>^{*5, 6}</p>  <p>(if equipped)</p>	<p>LDA indicator (→P. 571)</p>		<p>Parking brake indicator light (→P. 572)</p>



Speed warning light
(→P. 572)



Tire pressure warning
light (→P. 572)



Low AdBlue™ level
warning light (→P. 572)

- *1: These lights turn on when the engine switch is turned to the “ON” position (vehicles without smart entry & start system) or IGNITION ON mode (vehicles with smart entry & start system) to indicate that a system check is being performed. They will turn off after the engine is started, or after a few seconds. There may be a malfunction in a system if a light does not come on, or if the lights do not turn off. Have the vehicle inspected by any authorized Toyota dealer or repairer, or another duly qualified and equipped professional.
- *2: The light turns on or flashes to indicate a malfunction.
- *3: The light flashes rapidly to indicate a malfunction.
- *4: The light flashes to indicate a malfunction.
- *5: Vehicles with multi-information display type B.
- *6: The light illuminates in yellow to indicate a malfunction.
- *7: The lights illuminate on the center panel. تلفن شبانه روزی: ۰۲۱-۸۸۵۲۸۸۸۸

Indicators

The indicators inform the driver of the operating state of the vehicle's various systems.



Turn signal indicator
(→P. 260)



"SET" indicator
(→P. 314)



Headlight high beam indicator (→P. 264)



"ECO MODE" indicator
(→P. 249, 255)



Tail light indicator
(→P. 262)



"PWR MODE" indicator
(→P. 249, 255)



(if equipped)

Front fog light indicator
(→P. 269)



(if equipped)

*1
Downhill assist control system indicator
(→P. 361)



(if equipped)

Rear fog light indicator
(→P. 270)



(if equipped)

*1, 2
Slip indicator (→P. 354)



(if equipped)

*1
Eco Driving Indicator Light (→P. 126)



(if equipped)

*1
VSC OFF indicator
(→P. 355)



(if equipped)

*1
Stop & Start indicator
(→P. 343)



(if equipped)

*1
"TRC OFF" indicator
(→P. 355)



(if equipped)

*1
Stop & Start cancel indicator (→P. 344)

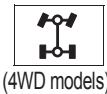

(4WD models)

*1
Four-wheel drive indicator (→P. 329)



(diesel engine)

Engine preheating indicator (→P. 236, 239)



(4WD models)

Low speed four-wheel drive indicator light (→P. 329)



(if equipped)

Cruise control indicator
(→P. 314)



(if equipped)

Rear differential lock indicator (→P. 339)

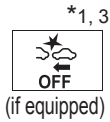

PCS warning light
(→P. 291)



Parking brake indicator
light (→P. 261)



LDA indicator (→P. 303)



“PASSENGER AIR
BAG” indicator
(→P. 57, 62)



Low outside
temperature indicator
(→P. 129)

- ^{*1}: These lights turn on when the engine switch is turned to the “ON” position (vehicles without smart entry & start system) or IGNITION ON mode (vehicles with smart entry & start system) to indicate that a system check is being performed. They will turn off after the engine is started, or after a few seconds. There may be a malfunction in a system if a light does not come on, or if the lights do not turn off. Have the vehicle inspected by any authorized Toyota dealer or repairer, or another duly qualified and equipped professional.
- ^{*2}: The light flashes to indicate that the system is operating.
- ^{*3}: The light turns on when the system is turned off.
- ^{*4}: The light illuminates in green when the system is operating. When the lane departure alert function is operating, the light illuminates in green (vehicles with multi-information display type A) or flashes in yellow (vehicles with multi-information display type B).
- ^{*5}: The light illuminates on the center panel.

■ Eco Driving Indicator (if equipped)

① Eco Driving Indicator Light

Vehicles with automatic transmission:

During Eco-friendly acceleration (Eco driving), Eco Driving Indicator Light will turn on. When the accelerator pedal is depressed excessively, or when the vehicle is stopped, the light turns off.

Vehicles with manual transmission:

During Eco-friendly acceleration or in Eco-friendly shift position (Eco driving), Eco Driving Indicator Light will turn on. When the accelerator pedal is depressed excessively, or when the vehicle is stopped, the light turns off.

② Eco Driving Indicator Zone Display (if equipped)

Suggests Zone of Eco driving with current Eco driving ratio based on acceleration.

③ Zone of Eco driving

④ Eco driving ratio based on acceleration

If the vehicle exceeds Zone of Eco driving, the right side of Eco Driving Indicator Zone Display will blink (vehicles with multi-information display type A) or illuminate (vehicles with multi-information display type B).

Eco Driving Indicator Light and Eco Driving Indicator Zone Display will not operate in the following conditions:

- The shift lever is in anything other than D. (vehicles with automatic transmission)
- The shift lever is in R. (vehicles with manual transmission)
- The vehicle is in the power mode. (if equipped) (→P. 249, 255)
- Downhill assist control system is operating. (if equipped) (→P. 361)
- Front-wheel drive control switch is in L4. (if equipped) (→P. 329)
- The vehicle speed is approximately 130 km/h (81 mph) or higher.

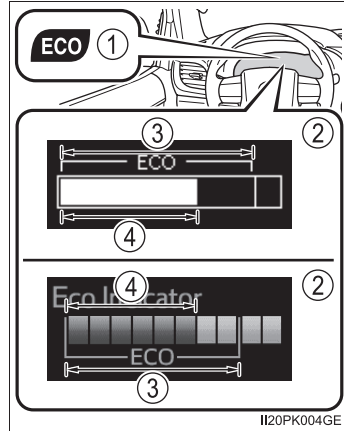

Eco Driving Indicator Light can be activated or deactivated.

Vehicles without multi-information display:

While the odometer is being displayed, press and hold the odometer/trip meter display change button to display the Eco Driving Indicator Light customization screen.

Press the odometer/trip meter display change button to set Eco Driving Indicator Light to on or off.

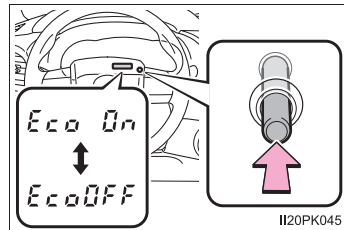

Press and hold the odometer/trip meter display change button for more than 2 seconds to complete the setting.

Vehicles with multi-information display: →P. 649

⚠ WARNING

■ If a safety system warning light does not come on

Should a safety system light such as ABS and the SRS warning light not come on when you start the engine, this could mean that these systems are not available to help protect you in an accident, which could result in death or serious injury. Have the vehicle inspected by any authorized Toyota dealer or repairer, or another duly qualified and equipped professional immediately if this occurs.

تلفن شبانه روزی: ۰۲۱-۸۸۸۶۲۰۸۵

FarmaSOS.com

Gauges and meters

► Vehicles without multi-information display

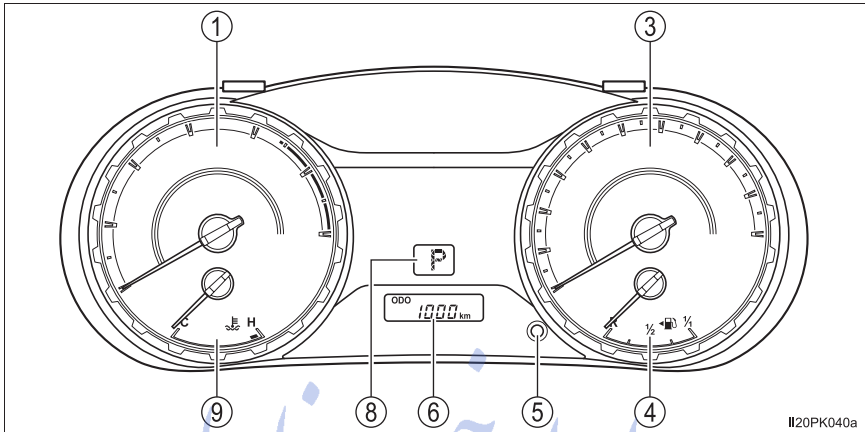

► Vehicles with multi-information display type A

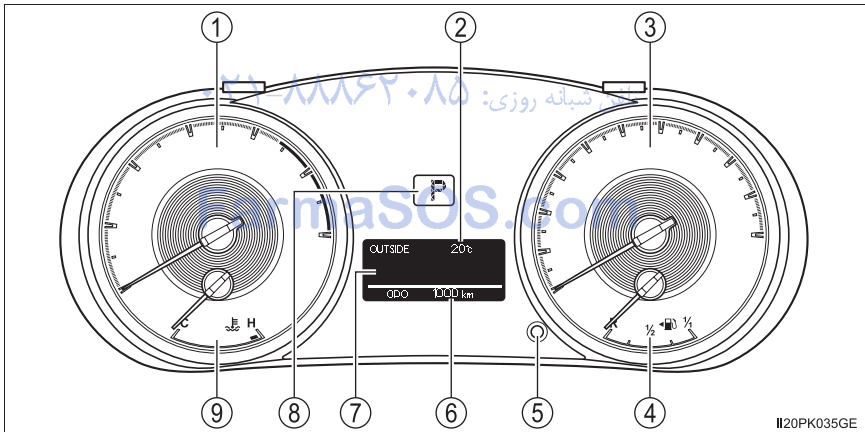

► Vehicles with multi-information display type B

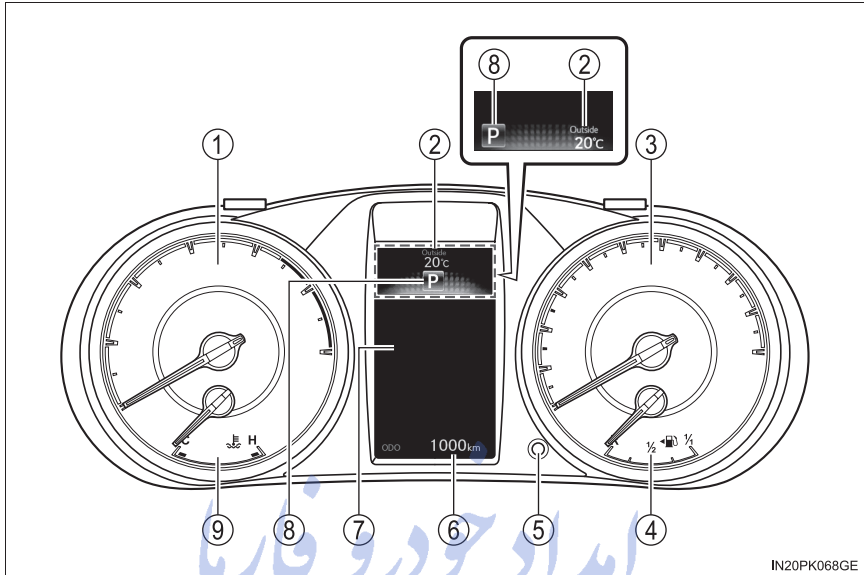

IN20PK068GE

The units used on the speedometer may differ depending on the target region, and the positions of the outside temperature and shift position indicators differ depending on vehicles.

- ① Tachometer تلفن شبانه روزی: ۰۲۱-۸۸۸۶۲۰۸۵
Displays the engine speed in revolutions per minute.
- ② Outside temperature
Displays the outside temperature. The temperature range that can be displayed is from -40°C (-40°F) to 50°C (122°F). The low outside temperature indicator comes on when the ambient temperature is approximately 3°C (37°F) or lower, and goes off when approximately 5°C (41°F) or higher. (→P. 125)
- ③ Speedometer
Displays the vehicle speed.
- ④ Fuel gauge
Displays the quantity of fuel remaining in the tank.
- ⑤ Odometer/trip meter display change button
→P. 130

⑥ Odometer and trip meter

Odometer:

Displays the total distance the vehicle has been driven.

Trip meter:

Displays the distance the vehicle has been driven since the meter was last reset. Trip meters A and B can be used to record and display different distances independently.

⑦ Multi-information display

Presents the driver with a variety of driving-related data. (→P. 133, 136)

⑧ Shift position and shift range (automatic transmission)

Displays the selected shift position or selected shift range. (→P. 247)

⑨ Engine coolant temperature gauge

Displays the engine coolant temperature.

Changing the display

► Vehicles without multi-information display

Pressing this button switches between odometer and trip meter displays.

① Odometer

② Trip meter A*

③ Trip meter B*

*: Pressing and holding the button will reset the trip meter.

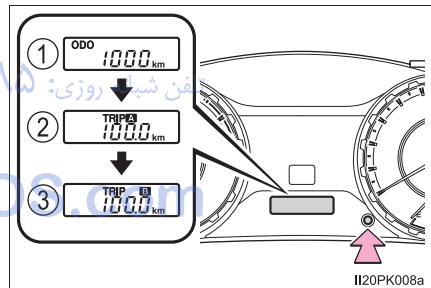

II20PK008a

► Vehicles with multi-information display

Pressing this button switches among odometer, trip meter and instrument panel light control displays.

- ① Odometer
- ② Trip meter A*¹
- ③ Trip meter B*¹
- ④ Instrument panel light control display*²

*¹: Pressing and holding the button will reset the trip meter.

*²: Pressing and holding the button will adjust brightness of the instrument panel lights.

For vehicles with multi-information display type A: Only the meter panel brightness can be adjusted.

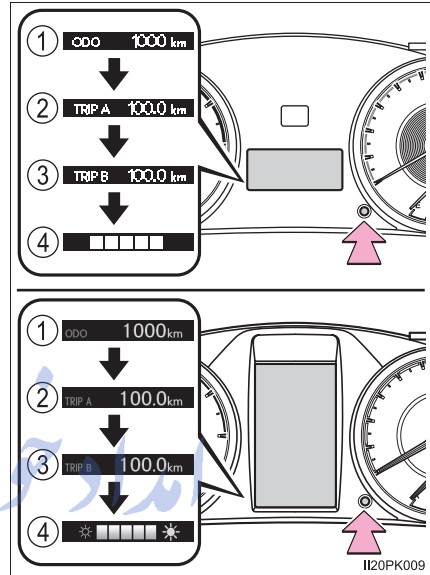

■ **The meters illuminate when** تلفن شبانه روزی: ۰۸۵ ۰۸۶۲ ۰۸۵

The engine switch is in the “ON” position (vehicles without smart entry & start system) or IGNITION ON mode (vehicles with smart entry & start system).

■ **The brightness of the instrument panel lights (vehicles with multi-information display)**

The instrument panel brightness levels when the tail lights are on and off can be adjusted individually. (on vehicles with multi-information display type A, only the meter panel brightness can be adjusted)

When the headlight switch is turned to on, the brightness will be reduced slightly unless the instrument panel brightness level is set to the brightest setting.

■ **When disconnecting and reconnecting battery terminals**

The trip meter data will be reset.

■ Outside temperature display

In the following situations, the correct outside temperature may not be displayed, or the display may take longer than normal to change:

- When the vehicle is stopped, or moving at low speeds (less than 20 km/h [12 mph])
- When the outside temperature has changed suddenly (at the entrance/exit of a garage, tunnel, etc.)

■ When "--" is displayed

The system may be malfunctioning. Take your vehicle to any authorized Toyota dealer or repairer, or another duly qualified and equipped professional.

WARNING

■ The information display at low temperatures (vehicles with multi-information display type B)

Allow the interior of the vehicle to warm up before using the liquid crystal information display. At extremely low temperatures, the display monitor may respond slowly, and display changes may be delayed.

For vehicles with automatic transmission: For example, there is a lag between the driver's shifting and the new gear number appearing on the display. This lag could cause the driver to downshift again, causing rapid and excessive engine braking and possibly an accident resulting in death or injury.

NOTICE

■ To prevent damage to the engine and its components

- Do not let the indicator needle of the tachometer enter the red zone, which indicates the maximum engine speed.
- The engine may be overheating if the engine coolant temperature gauge is in the red zone (H). In this case, immediately stop the vehicle in a safe place, and check the engine after it has cooled completely. (→P. 613)

■ The information display at low temperatures (vehicles with multi-information display type A)

Allow the interior of the vehicle to warm up before using the liquid crystal information display. At extremely low temperatures, the display monitor may respond slowly, and display changes may be delayed.

Multi-information display (Type A)*

Display contents

The multi-information display presents the driver with a variety of driving-related data.

- Trip information (→P. 134)

Displays driving range, fuel consumption and other cruising-related information.

- Setting (→P. 649)

The settings of the following items can be changed.

- Language

Select to change the language on the display.

- Units

Select to change the units for measure of the fuel consumption.

- Eco Driving Indicator Light

Select to activate/deactivate the Eco Driving Indicator Light.

- LDA (Lane Departure Alert) (→P. 300)

Displays the lane departure alert function display when the system is turned on.

- Warning messages (→P. 577)

Displays warning messages and measures to be taken if a malfunction is detected.

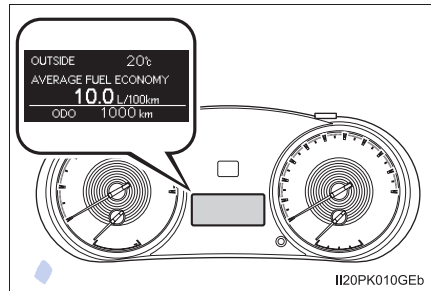

Switching the display

“DISP” button

Items displayed can be switched by pressing the “DISP” button.

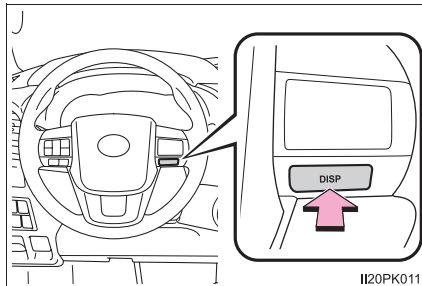

Trip information

■ Current fuel consumption

Displays the current rate of fuel consumption.

■ Average fuel consumption

Displays the average fuel consumption since the engine switch is turned to the “ON” position (vehicles without smart entry & start system) or IGNITION ON mode (vehicles with smart entry & start system).

- The function can be reset by pressing the “DISP” button for longer than 1 second when the average fuel consumption is displayed.
- Use the displayed average fuel consumption as a reference.

■ Driving range

Displays the estimated maximum distance that can be driven with the quantity of fuel remaining.

- This distance is computed based on your average fuel consumption. As a result, the actual distance that can be driven may differ from that displayed.
- When only a small amount of fuel is added to the tank, the display may not be updated.

When refueling, turn the engine switch to the “LOCK” position (vehicles without smart entry & start system) or off (vehicles with smart entry & start system). If the vehicle is refueled without turn the engine switch to the “LOCK” position or off, the display may not updated.

■ Average vehicle speed

Displays the average vehicle speed since the engine switch is turned to the “ON” position (vehicles without smart entry & start system) or IGNITION ON mode (vehicles with smart entry & start system).

The function can be reset by pressing the “DISP” button for longer than 1 second when the average vehicle speed is displayed.

■ Elapsed time

Displays the elapsed time after the engine switch is turned to the “ON” position (vehicles without smart entry & start system) or IGNITION ON mode (vehicles with smart entry & start system).

- When the engine switch is turned on, time is counted from 00:00. When the time exceeds 99:59, the counter returns to 00:00.
- The function can be reset by pressing the “DISP” button for longer than 1 second when the elapsed time is displayed.

■ Eco Driving Indicator Zone Display (if equipped)

Displays Zone of Eco driving with current Eco driving ratio based on acceleration. (→P. 126)

■ Display off

A blank screen is displayed.

■ Setting display automatic cancelation

In the following situations, setting display in which the settings can be changed through the “DISP” button will automatically be turned off.

- If a warning message appears while the setting display is displayed
- When the vehicle begins to move while the setting display is displayed

■ When disconnecting and reconnecting battery terminals

The trip information data and settings will be reset.

■ Liquid crystal display

Small spots or light spots may appear on the display. This phenomenon is characteristic of liquid crystal displays, and there is no problem continuing to use the display.

■ Customization

Settings (e.g. on/off operation of the Eco Driving Indicator Light) can be changed.

(Customizable features: →P. 648)

Multi-information display (Type B)*

Display contents

The multi-information display presents the driver with a variety of vehicle data.

The following information will be displayed when a menu icon is selected. (→P. 137)

Some of the information may be displayed automatically depending on the situation.

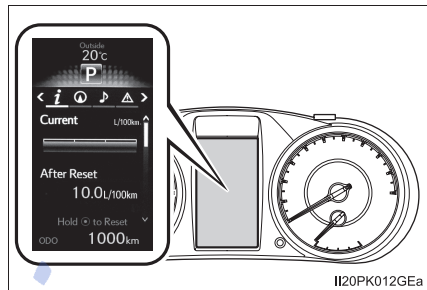

Drive information

Select to display various drive data. (→P. 138)



Navigation system-linked display (if equipped)

Select to display the following navigation system-linked information.

- Route guidance
- Compass display



Audio system-linked display (if equipped)

Select to enable selection of an audio source or track on the meter using the meter control switches.



Driving assist system information (if equipped)

Select to display the LDA (Lane Departure Alert) or RSA (Road Sign Assist) information, when the system is used. (→P. 300, 309)

*: If equipped



Warning message display

Select to display warning messages and measures to be taken if a malfunction is detected. (→P. 577)



Settings display

Select to change the meter display settings. (→P. 650)

Operating the meter control switches

The multi-information display is operated using the meter control switches.

- ① Enter/Set
- ② Select an item/Change pages
- ③ Return to the previous screen
- ④ Press: Displays the screen registered as the top screen

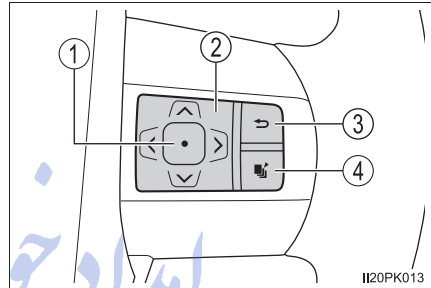

When no screen has been registered, the drive information screen will be displayed.

Press and hold: Registers the currently displayed screen as the top screen

When the confirmation screen is displayed, select yes to register the screen. If the selected screen cannot be registered, a registration failure message will be shown.

Drive information

Items displayed can be switched by pressing “<” or “>” of the meter control switches to select **i** and pressing “^” or “v”.

- Current fuel economy (bar type/value type)*^{1, 2}

Displays the current rate of fuel consumption.

- Average fuel economy (after reset*³/after start/after refuel)*^{1, 2}

Displays the average fuel consumption since the function was reset, the engine was started and the vehicle was refueled respectively.

- Average speed (after reset*³/after start)*¹

Displays the average vehicle speed since function was reset and the engine was started respectively.

- Elapsed time (after reset*³/after start)*¹

Displays the elapsed time since the function was reset and the engine was started respectively.

- Distance (range/after start)*¹

Displays the estimated maximum distance that can be driven with the quantity of fuel remaining and the distance driven after the engine was started respectively.

- This distance is computed based on your average fuel consumption. As a result, the actual distance that can be driven may differ from that displayed.
- When only a small amount of fuel is added to the tank, the display may not be updated.

When refueling, turn the engine switch off. If the vehicle is refueled without turning the engine switch off, the display may not be updated.

- Idling stop (if equipped)

Displays the total idling stop time (engine stop time via the Stop & Start system) after resetting and engine startup. (→P. 348)

- Eco Driving Indicator Zone Display (if equipped)

Displays Zone of Eco driving with current Eco driving ratio based on acceleration. (→P. 126)

- Eco Score (if equipped)

Displays the eco-driving total count to help improve the customer's eco driving techniques. (→P. 141)

- Eco Saving

Displays the fuel consumption comparison, the average fuel consumption after reset, and the cost of the consumed fuel. (→P. 142)

- Vehicle sway warning (if equipped)

Detects the sway of the vehicle within a lane, which is often associated with a decrease in the driver's attention level, and displays the decrease in attention using a bar display.

The longer the bar length, the more the driver may need to rest.

This display is a part of the LDA (Lane Departure Alert) system. The display is enabled when the operating conditions of the vehicle sway warning function are met. (→P. 300)

- Display off

A blank screen is displayed.

*1: Can be registered to drive information 1 and 2. (→P. 140)

*2: Use the displayed fuel consumption as a reference.

*3: Resetting procedures:

- Select a function to be reset using the meter control switches and then press and hold to reset.
- If there is more than one function that can be reset, check boxes will be displayed next to those functions.

Settings display

The settings of the following items can be changed, refer to P. 648

- RSA (Road Sign Assist) (if equipped)

Select to set the followings.

- RSA on/off
- Notification method (excess speed/others*)
- Excess speed notification level

- Idling stop (if equipped)

Select to change the idling stop time when the air conditioning system is turned on.

- Language

Select to change the language on the display.

- Units

Select to change the unit for measure of the fuel consumption.

- Eco Driving Indicator Light (if equipped)

Select to activate/deactivate the Eco Driving Indicator Light.
(→P. 126)

-  switch settings

You can register 1 screen as the top screen. To register, press and hold  while the desired screen is displayed.

- Drive information 1 and 2

Select to select up to 2 items that will be displayed on a drive information screen, up to 2 drive information screens can be set.

- Pop-up display

Select to set the following pop-up displays, which may appear in some situations, on/off.

- Route guidance display of the navigation system-linked system (if equipped)
- Incoming call display of the hands-free phone system (if equipped)

- Accent color

Select to change the accent colors on the screen, such as the cursor color.

- Eco Saving

Select to set or change the fuel consumption comparison and fuel price.

- Initialization

Registered or changed meter settings will be deleted or returned to their default setting.

*: No-overtaking notification only.

■ Pop-up display

In some situations, such as when a switch operation is performed, a pop-up display will be temporarily displayed on the multi-information display.

The pop-up display function can be set on/off. (→P. 650)

■ Eco Score (if equipped)

Driving conditions are displayed in 5 stages and divided into 3 categories: start, cruise and stop. Every time the vehicle is stopped, the score is displayed. (Every time the vehicle is accelerated the score that was last displayed is reset. Accumulative scores are not calculated.)

① Eco Score

Totals the counts of the eco start, eco cruise and eco stop, and displays the result.

② Eco start

Displays the eco level calculated from degree of acceleration when starting the vehicle

③ Eco cruise

Displays the eco level calculated from acceleration operation amount when driving the vehicle

④ Eco stop

Displays the eco level calculated from time between releasing the accelerator pedal and vehicle stop

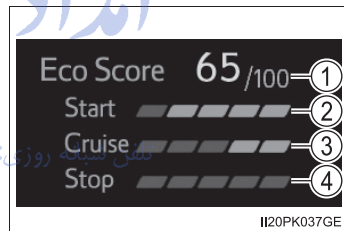

If the accelerator pedal is not depressed, such as when the vehicle is driven using cruise control (if equipped), the driven distance is not included in the Eco Score.

The Eco Score evaluation differs depending on the driving conditions and environmental factors. The Eco Score may not be linked to fuel consumption. The Eco Score will not operate in the following conditions:

- The vehicle speed is approximately 130 km/h (80 mph) or higher.
- The shift lever is in a position other than D. (vehicles with automatic transmission)
- Front-wheel drive control switch is in L4. (if equipped)
- Downhill assist control system is operating. (if equipped)
- The vehicle is in the power mode. (if equipped)

■ Eco Saving

Displays the fuel consumption comparison, the average fuel consumption after reset, and the cost of the consumed fuel.

① Fuel consumption comparison

Displays the set fuel consumption that is compared with the actual fuel consumption.

② Average fuel consumption after reset

Displays the average fuel consumption since the function was reset.



- The function can be reset by pressing  more than 1 second when the average fuel consumption after reset is displayed
- Use the average fuel consumption as a reference

③ Savings/fuel cost

Displays the possible savings if the fuel consumption comparison is set, and displays the actual fuel cost if the fuel consumption comparison is not set.

Use the displayed fuel cost and savings as a reference. Depending on refueling methods, driving conditions and environmental factors, the displayed fuel cost may differ from the actual fuel cost, and in some cases, the fuel cost and savings may not be linked to the Eco Score evaluation.

■ Eco Saving setting

The fuel price and fuel consumption comparison settings can be set in the settings display. Use the meter control switches to select  while the vehicle is stopped and press , and select "Eco Saving" and press .

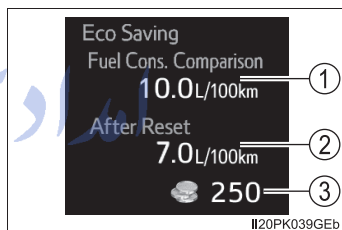

■ Setting display automatic cancelation

In the following situations, setting display in which the settings can be changed through the meter control switches will automatically be turned off.

- If a warning message appears while the setting display is displayed
- When the vehicle begins to move while the setting display is displayed

■ When disconnecting and reconnecting battery terminals

The drive information data and settings will be reset.

■ Liquid crystal display

Small spots or light spots may appear on the display. This phenomenon is characteristic of liquid crystal displays, and there is no problem continuing to use the display.



WARNING

■ Eco Score

Use the Eco Score as a reference. Always drive safely in accordance with road and traffic conditions.

امداد خودرو فارما

تلفن شبانه روزی: ۰۲۱-۸۸۸۶۲۰۸۵

FarmaSOS.com

Fuel consumption information*

The fuel consumption information can be displayed on the navigation system or multimedia system screen.

Display the trip information or past record screen

- 1 Press the “CAR” button.
- 2 Select “Trip information” or “Past record”.

Fuel consumption

■ Trip information

If the trip information screen does not appear, select “Trip information”.

- ① Average vehicle speed
- ② Cruising range
- ③ Previous fuel consumption per minute
- ④ Current fuel consumption
- ⑤ Reset the trip information data
- ⑥ Elapsed time
- ⑦ “Past record” screen appears

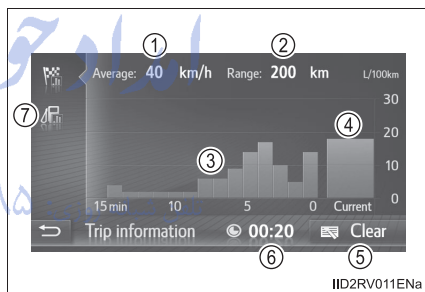

Average fuel consumption for the past 15 minutes is divided by color into past averages and averages attained since the engine switch was last turned to the “ON” position (vehicles without smart entry & start system) or IGNITION ON mode (vehicles with smart entry & start system). Use the displayed average fuel consumption as a reference.

These images are examples only, and may vary slightly from actual conditions.

*: If equipped

■ Past record

If the past record screen data does not appear, select “Past record”.

- ① Best recorded fuel consumption
- ② Previous fuel consumption record
- ③ Current fuel consumption
- ④ Reset the past record data
- ⑤ Update the past record data
- ⑥ “Trip information” screen appears

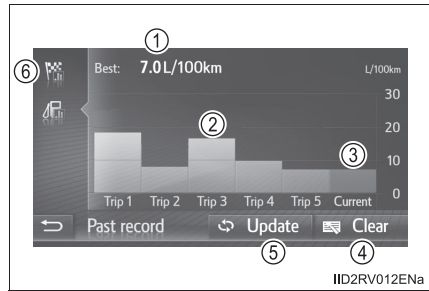

The average fuel consumption history is divided by color into past averages and the average fuel consumption since the last updated. Use the displayed average fuel consumption as a reference.

These images are examples only, and may vary slightly from actual conditions.

■ Resetting the data

Selecting “Clear” on the “Trip information” screen will reset the trip information data.

Selecting “Clear” on the “Past record” screen will reset the past record data.

■ Updating the past record data

Selecting “Update” on the “Past record” screen will update the past record data.

Also, the average fuel consumption displayed in the multi-information display will be reset at the same time.

■ Cruising range

Displays the estimated maximum distance that can be driven with the quantity of fuel remaining.

This distance is computed based on your average fuel consumption. As a result, the actual distance that can be driven may differ from that displayed.

امداد خودرو فارما

تلفن شبانه روزی: ۰۲۱-۸۸۸۶۲۰۸۵

FarmaSOS.com

Operation of each component

3

3-1. Key information

Keys..... 148

3-2. Opening, closing and locking the doors

Side doors..... 160

Access panels (smart-cab models only) 166

Tailgate 167

Smart entry & start system 170

3-3. Adjusting the seats

Front seats 186

Rear seats 188

Head restraints 191

3-4. Adjusting the steering wheel and mirrors

Steering wheel 194

Inside rear view mirror 196

Outside rear view mirrors 197

3-5. Opening and closing the windows

Power windows 200

Quarter windows (smart-cab models)..... 204

Back window (sliding type) 205

Keys

The keys

The following keys are provided with the vehicle.

► Type A

- ① Master keys
- ② Valet key
- ③ Key number plate

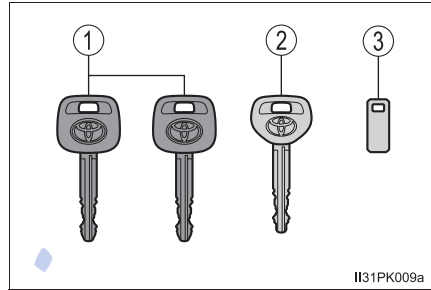

► Type B

- ① Master keys
- ② Valet key
- ③ Key number plate

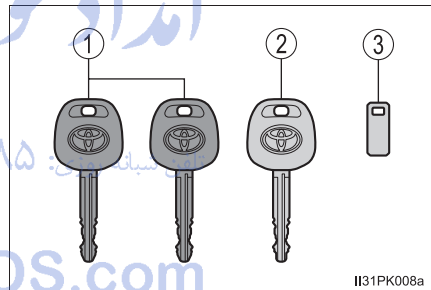

► Type C

- ① Master keys
Operating the wireless remote control function (→P. 150)
- ② Valet key
- ③ Key number plate

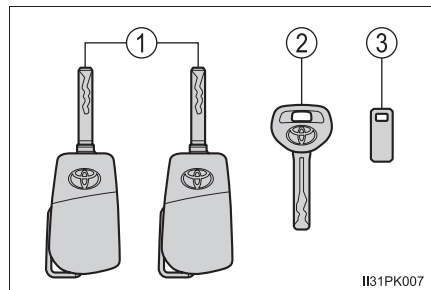

▶ Type D

- ① Master keys
 - Operating the wireless remote control function (→P. 150)
- ② Valet key
- ③ Key number plate

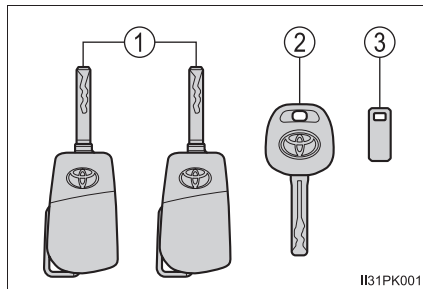

II31PK001

▶ Type E (vehicles with smart entry & start system)

- ① Electronic keys
 - Operating the smart entry & start system (→P. 170)
 - Operating the wireless remote control function (→P. 150)
- ② Mechanical keys
- ③ Key number plate

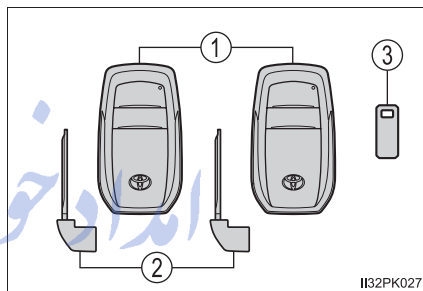

II32PK027

▶ Type F (vehicles with smart entry & start system)

- ① Electronic keys
 - Operating the smart entry & start system (→P. 170)
 - Operating the wireless remote control function (→P. 150)
- ② Mechanical keys
- ③ Key number plate
- ④ Mechanical keys (supplementary keys)

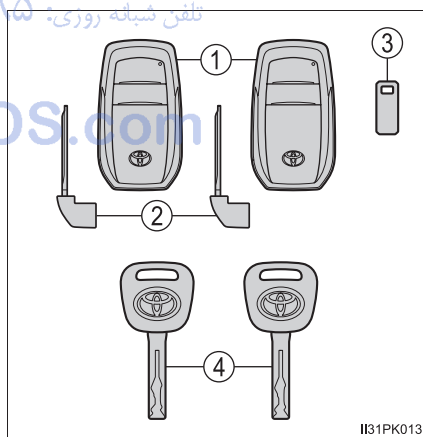

II31PK013

Wireless remote control (if equipped)

▶ Vehicles without smart entry & start system

- ① Locks all the doors (→P. 160)
Check that the door is securely locked.
- ② Unlocks all the doors (→P. 160)
- ③ Sounds the alarm* (→P. 151)

*: If equipped

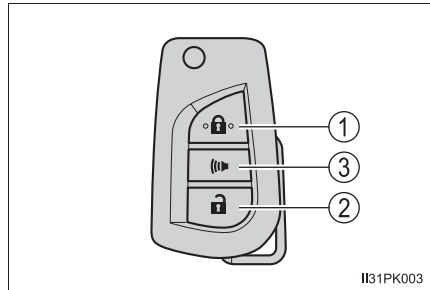

▶ Vehicles with smart entry & start system

- ① Locks all the doors (→P. 160)
Check that the door is securely locked.
- ② Unlocks all the doors (→P. 160)

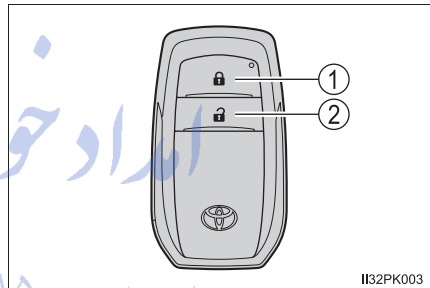

Using the master key (type C and D)

- ① Releasing
To release the key, press the button.
- ② Folding
To stow the key back in its case, push the key back to the stowed position while pressing the button.

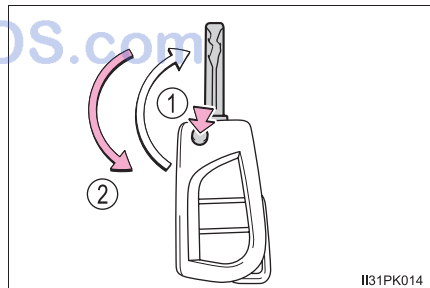

Using the mechanical key (vehicles with smart entry & start system)

To take out the mechanical key, slide the release lever and take the key out.

The mechanical key can only be inserted in one direction, as the key only has grooves on one side. If the key cannot be inserted in a lock cylinder, turn it over and re-attempt to insert it.

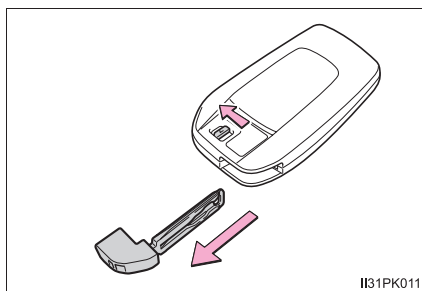

II31PK011

After using the mechanical key, store it in the electronic key. Carry the mechanical key together with the electronic key. If the electronic key battery is depleted or the entry function does not operate properly, you will need the mechanical key. (→P. 603)

■ Panic mode (if equipped)

When  is pressed for longer than about one second, an alarm will sound intermittently and the vehicle lights will flash to deter any person from trying to break into or damage your vehicle.

To stop the alarm, press any button on the wireless remote control.



II31PK005

■ When required to leave the vehicle's key with a parking attendant

Lock the glove box as circumstances demand. (→P. 470)

▶ Vehicles without smart entry & start system

Carry the master key for your own use and provide the attendant with the valet key.

▶ Vehicles with smart entry & start system

Remove the mechanical key for your own use and provide the attendant with the electronic key only. If there is the supplementary key, carry the supplementary key for your own use as well as the mechanical key.

■ If you lose your keys

New genuine keys can be made by any authorized Toyota dealer or repairer, or another duly qualified and equipped professional using a master key (vehicles without smart entry & start system) or the other key of the same type (vehicles with smart entry & start system), and the key number stamped on your key number plate. Keep the plate in a safe place such as your wallet, not in the vehicle.

■ When riding in an aircraft (type C, D, E and F)

When bringing a key with wireless remote control function onto an aircraft, make sure you do not press any buttons on the key while inside the aircraft cabin. If you are carrying the key in your bag etc., ensure that the buttons are not likely to be pressed accidentally. Pressing a button may cause the key to emit radio waves that could interfere with the operation of the aircraft.

■ Key battery depletion**▶ Vehicles without smart entry & start system**

If the wireless remote control function does not operate, the battery may be depleted. Replace the battery when necessary. (→P. 532)

▶ Vehicles with smart entry & start system

→P. 175

■ If “KEY BATTERY LOW”/“Key battery low” is shown on the multi-information display (if equipped)

The electronic key has a low battery. Replace the electronic key battery.

■ Replacing the electronic key battery

→P. 532

■ Confirmation of the registered key number

The number of keys already registered to the vehicle can be confirmed. Ask any authorized Toyota dealer or repairer, or another duly qualified and equipped professional for details.

■ Certification for wireless remote control

<p>Hereby, Tokai Rika Co., Ltd., declares that this B62RA is in compliance with the essential requirements and other relevant provisions of Directive 1999/5/EC.</p>
<p>Tokai Rika Co., Ltd. vakuuttaa täten että B62RA tyyppinen laite on direktiivin 1999/5/EY oleellisten vaatimusten ja sitä koskevien direktiivin muiden ehtojen mukainen.</p>
<p>Hierbij verklaart Tokai Rika Co., Ltd. dat het toestel B62RA in overeenstemming is met de essentiële eisen en de andere relevante bepalingen van richtlijn 1999/5/EG.</p>
<p>Par la présente Tokai Rika Co., Ltd. déclare que l'appareil B62RA est conforme aux exigences essentielles et aux autres dispositions pertinentes de la directive 1999/5/CE.</p>
<p>Härmed intygar Tokai Rika Co., Ltd. att denna B62RA står i överensstämmelse med de väsentliga egenskapskrav och övriga relevanta bestämmelser som framgår av direktiv 1999/5/EG.</p>
<p>Undertegnede Tokai Rika Co., Ltd. erklærer herved, at følgende udstyr B62RA overholder de væsentlige krav og øvrige relevante krav i direktiv 1999/5/EF.</p>
<p>Hiermit erklärt Tokai Rika Co., Ltd., dass sich das Gerät B62RA in Übereinstimmung mit den grundlegenden Anforderungen und den übrigen einschlägigen Bestimmungen der Richtlinie 1999/5/EG befindet.</p>
<p>ΜΕ ΤΗΝ ΠΑΡΟΥΣΑ Tokai Rika Co., Ltd. ΔΗΛΩΝΕΙ ΟΤΙ Β62RA ΣΥΜΜΟΡΦΩΝΕΤΑΙ ΠΡΟΣ ΤΙΣ ΟΥΣΙΩΔΕΙΣ ΑΠΑΙΤΗΣΕΙΣ ΚΑΙ ΤΙΣ ΛΟΙΠΕΣ ΣΧΕΤΙΚΕΣ ΔΙΑΤΑΞΕΙΣ ΤΗΣ ΟΔΗΓΙΑΣ 1999/5/ΕΚ.</p>
<p>Con la presente Tokai Rika Co., Ltd. dichiara che questo B62RA è conforme ai requisiti essenziali ed alle altre disposizioni pertinenti stabilite dalla direttiva 1999/5/CE.</p>
<p>Por medio de la presente Tokai Rika Co., Ltd. declara que el B62RA cumple con los requisitos esenciales y cualesquiera otras disposiciones aplicables o exigibles de la Directiva 1999/5/CE.</p>
<p>Tokai Rika Co., Ltd. declara que este B62RA está conforme com os requisitos essenciais e outras disposições da Directiva 1999/5/CE.</p>

Hawnhekk, Tokai Rika Co., Ltd., jiddikjara li dan B62RA jikkonforma mal-ħtiġijiet essenzjali u ma provvedimenti oħrajn relevanti li hemm fid-Dirrettiva 1999/5/EC.
Käesolevaga kinnitab Tokai Rika Co., Ltd. seadme B62RA vastavust direktiivi 1999/5/EÜ põhinoetele ja nimetatud direktiivist tulenevatele teistele asjakohastele sätetele.
Alulírott, Tokai Rika Co., Ltd. nyilatkozom, hogy a B62RA megfelel a vonatkozó alapvető követelményeknek és az 1999/5/EC irányelv egyéb előírásainak.
Tokai Rika Co., Ltd. týmto vyhlasuje, že B62RA spĺňa základné požiadavky a všetky príslušné ustanovenia Smernice 1999/5/ES.
Tokai Rika Co., Ltd. tímto prohlašuje, že tento B62RA je ve shodě se základními požadavky a dalšími příslušnými ustanoveními směrnice 1999/5/ES.
Tokai Rika Co., Ltd. izjavlja, da je ta B62RA v skladu z bistvenimi zahtevami in ostalimi relevantnimi določili direktive 1999/5/ES.
Šiuo Tokai Rika Co., Ltd. deklaruoja, kad šis B62RA atitinka esminius reikalavimus ir kitas 1999/5/EB Direktyvos nuostatas.
Ar šo Tokai Rika Co., Ltd. deklarē, ka B62RA atbilst Direktīvas 1999/5/EK būtiskajām prasībām un citiem ar to saistītajiem noteikumiem.
Niniejszym Tokai Rika Co., Ltd. oświadcza, że B62RA jest zgodny z zasadniczymi wymogami oraz pozostałymi stosownymi postanowieniami Dyrektywy 1999/5/EC.
Hér með lýsir Tokai Rika Co., Ltd. yfir því að B62RA er í samræmi við grunnkröfur og aðrar kröfur, sem gerðar eru í tilskipun 1999/5/EC.
Tokai Rika Co., Ltd. erklærer herved at utstyret B62RA er i samsvar med de grunnleggende krav og øvrige relevante krav i direktiv 1999/5/EF.
С настоящето, Tokai Rika Co., Ltd., декларира, че B62RA е в съответствие със съществените изисквания и другите приложими разпоредби на Директива 1999/5/EC.

<p>Prin prezenta, Tokai Rika Co., Ltd., declară că aparatul B62RA este în conformitate cu cerințele esențiale și cu alte prevederi pertinente ale Directivei 1999/5/CE.</p>
<p>Ovim, Tokai Rika Co., Ltd., izjavljuje da ovaj B62RA je usklađen sa bitnim zahtjevima i drugim relevantnim odredbama Direktive 1999/5/EC.</p>
<p>Nepermjet kesaj, Tokai Rika Co., Ltd., deklaroi qe ky B62RA eshte ne pajtim me kerkesat thelbesore dhe dispozitat e tjera perkatese te Direktives 1999/5/EC.</p>
<p>Ovim Tokai Rika Co., Ltd., izjavljuje da je B62RA u skladu s bitnim zahtjevima i drugim relevantnim odredbama Direktive 1999/5/EC i Pravilnika o RiTT opremi (NN 25/2012).</p>
<p>Ovim, Tokai Rika Co., Ltd., deklarirše da je B62RA u skladu sa osnovnim zahtevima i ostalim relevantnim odredbama Direktive 1999/5/EC.</p>

The DECLARATION of CONFORMITY (DoC) is available at the following address:

<http://www.tokai-rika.co.jp/pc>



تلفن شبانه روزی: ۰۲۱-۸۸۸۶۲۰۸۵

FarmaSOS.com

<p>Hereby, Tokai Rika Co., Ltd., declares that this BA2TA is in compliance with the essential requirements and other relevant provisions of Directive 1999/5/EC.</p>
<p>Tokai Rika Co., Ltd. vakuuttaa täten että BA2TA tyyppinen laite on direktiivin 1999/5/EY oleellisten vaatimusten ja sitä koskevien direktiivin muiden ehtojen mukainen.</p>
<p>Hierbij verklaart Tokai Rika Co., Ltd. dat het toestel BA2TA in overeenstemming is met de essentiële eisen en de andere relevante bepalingen van richtlijn 1999/5/EG.</p>
<p>Par la présente Tokai Rika Co., Ltd. déclare que l'appareil BA2TA est conforme aux exigences essentielles et aux autres dispositions pertinentes de la directive 1999/5/CE.</p>
<p>Härmed intygar Tokai Rika Co., Ltd. att denna BA2TA står i överensstämmelse med de väsentliga egenskapskrav och övriga relevanta bestämmelser som framgår av direktiv 1999/5/EG.</p>
<p>Undertegnede Tokai Rika Co., Ltd. erklærer herved, at følgende udstyr BA2TA overholder de væsentlige krav og øvrige relevante krav i direktiv 1999/5/EF.</p>
<p>Hiermit erklärt Tokai Rika Co., Ltd., dass sich das Gerät BA2TA in Übereinstimmung mit den grundlegenden Anforderungen und den übrigen einschlägigen Bestimmungen der Richtlinie 1999/5/EG befindet.</p>
<p>ΜΕ ΤΗΝ ΠΑΡΟΥΣΑ Tokai Rika Co., Ltd. ΔΗΛΩΝΕΙ ΟΤΙ ΒΑ2ΤΑ ΣΥΜΜΟΡΦΩΝΕΤΑΙ ΠΡΟΣ ΤΙΣ ΟΥΣΙΩΔΕΙΣ ΑΠΑΙΤΗΣΕΙΣ ΚΑΙ ΤΙΣ ΛΟΙΠΕΣ ΣΧΕΤΙΚΕΣ ΔΙΑΤΑΞΕΙΣ ΤΗΣ ΟΔΗΓΙΑΣ 1999/5/ΕΚ.</p>
<p>Con la presente Tokai Rika Co., Ltd. dichiara che questo BA2TA è conforme ai requisiti essenziali ed alle altre disposizioni pertinenti stabilite dalla direttiva 1999/5/CE.</p>
<p>Por medio de la presente Tokai Rika Co., Ltd. declara que el BA2TA cumple con los requisitos esenciales y cualesquiera otras disposiciones aplicables o exigibles de la Directiva 1999/5/CE.</p>
<p>Tokai Rika Co., Ltd. declara que este BA2TA está conforme com os requisitos essenciais e outras disposições da Directiva 1999/5/CE.</p>

Hawnhekk, Tokai Rika Co., Ltd., jiddikjara li dan BA2TA jikkonforma mal-ħtiġijiet essenzjali u ma provvedimenti oħrajn relevanti li hemm fid-Dirrettiva 1999/5/EC.
Käesolevaga kinnitab Tokai Rika Co., Ltd. seadme BA2TA vastavust direktiivi 1999/5/EÜ põhioletule ja nimetatud direktiivist tulenevatele teistele asjakohastele sätetele.
Alulírótt, Tokai Rika Co., Ltd. nyilatkozom, hogy a BA2TA megfelel a vonatkozó alapvető követelményeknek és az 1999/5/EC irányelv egyéb előírásainak.
Tokai Rika Co., Ltd. týmto vyhlasuje, že BA2TA spĺňa základné požiadavky a všetky príslušné ustanovenia Smernice 1999/5/ES.
Tokai Rika Co., Ltd. tímto prohlašuje, že tento BA2TA je ve shodě se základními požadavky a dalšími příslušnými ustanoveními směrnice 1999/5/ES.
Tokai Rika Co., Ltd. izjavlja, da je ta BA2TA v skladu z bistvenimi zahtevami in ostalimi relevantnimi določili direktive 1999/5/ES.
Šiuo Tokai Rika Co., Ltd. deklaruoja, kad šis BA2TA atitinka esminius reikalavimus ir kitas 1999/5/EB Direktyvos nuostatas.
Ar šo Tokai Rika Co., Ltd. deklarē, ka BA2TA atbilst Direktīvas 1999/5/EK būtiskajām prasībām un citiem ar to saistītajiem noteikumiem.
Niniejszym Tokai Rika Co., Ltd. oświadcza, że BA2TA jest zgodny z zasadniczymi wymogami oraz pozostałymi stosownymi postanowieniami Dyrektywy 1999/5/EC.
Hér með lýsir Tokai Rika Co., Ltd. yfir því að BA2TA er í samræmi við grunnkröfur og aðrar kröfur, sem gerðar eru í tilskipun 1999/5/EC.
Tokai Rika Co., Ltd. erklærer herved at utstyret BA2TA er i samsvar med de grunnleggende krav og øvrige relevante krav i direktiv 1999/5/EF.
С настоящето, Tokai Rika Co., Ltd., декларира, че BA2TA е в съответствие със съществените изисквания и другите приложими разпоредби на Директива 1999/5/EC.

Prin prezenta, Tokai Rika Co., Ltd., declară că aparatul BA2TA este in conformitate cu cerințele esențiale și cu alte prevederi pertinente ale Directivei 1999/5/CE.
Ovim, Tokai Rika Co., Ltd., izjavljuje da ovaj BA2TA je usklađen sa bitnim zahtjevima i drugim relevantnim odredbama Direktive 1999/5/EC.
Nepermjet kesaj, Tokai Rika Co., Ltd., deklaroi qe ky BA2TA eshte ne pajtim me kerkesat thelbesore dhe dispozitat e tjera perkatese te Direktives 1999/5/EC.
Ovim Tokai Rika Co., Ltd., izjavljuje da je BA2TA u sklau s bitnim zahtjevima i drugim relevantnim odredbama Direktive 1999/5/EC i Pravilnika o RiTT opremi (NN 25/2012).
Ovim, Tokai Rika Co., Ltd., deklarirše da je BA2TA u skladu sa osnovnim zahtevima i ostalim relevantnim odredbama Direktive 1999/5/EC.

The DECLARATION of CONFORMITY (DoC) is available at the following address:
<http://www.tokai-rika.co.jp/pc>



تلفن شبانه روزی: ۰۲۱-۸۸۸۶۲۰۸۵

► For vehicles sold in Serbia



 NOTICE**■ To prevent key damage**

- Do not drop the keys, subject them to strong shocks or bend them.
- Do not expose the keys to high temperatures for long periods of time.
- Do not get the keys wet or wash them in an ultrasonic washer etc.
- Do not attach metallic or magnetic materials to the keys or place the keys close to such materials.
- Do not disassemble the keys.
- Do not attach a sticker or anything else to the surface of the electronic key.
- Do not place the keys near objects that produce magnetic fields, such as TVs, audio systems and induction cookers, or medical electrical equipment, such as low-frequency therapy equipment.

■ Carrying the electronic key on your person (vehicles with smart entry & start system)

Carry the electronic key 10 cm (3.9 in.) or more away from electric appliances that are turned on. Radio waves emitted from electric appliances within 10 cm (3.9 in.) of the electronic key may interfere with the key, causing the key to not function properly.

■ In case of a smart entry & start system malfunction or other key-related problems (vehicles with smart entry & start system)

Take your vehicle with all the electronic keys provided with your vehicle to any authorized Toyota dealer or repairer, or another duly qualified and equipped professional.

■ When an electronic key is lost (vehicles with smart entry & start system)

If the electronic key remains lost, the risk of vehicle theft increases significantly. Visit any authorized Toyota dealer or repairer, or another duly qualified and equipped professional immediately with all remaining electronic keys that were provided with your vehicle.

Side doors

The vehicle can be locked and unlocked using the entry function, wireless remote control, key or door lock switch.

Locking and unlocking the doors from outside

◆ Smart entry & start system (if equipped)

While carrying the electronic key, press the button to lock and unlock.

After locking, check that the door is securely locked.

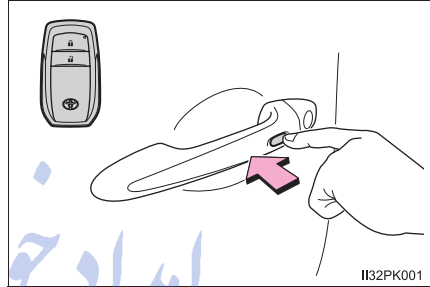

◆ Wireless remote control (if equipped)

- ▶ Vehicles without smart entry & start system ▶ Vehicles with smart entry & start system

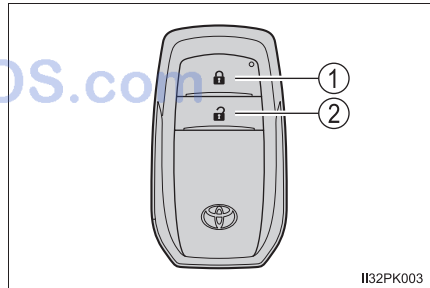
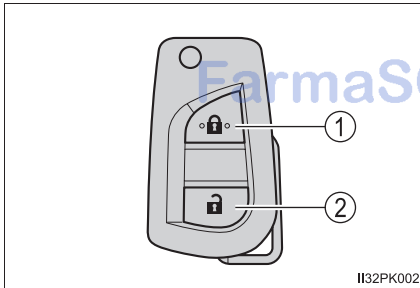

- ① Locks all the doors

Check that the door is securely locked.

- ② Unlocks all the doors

◆ Key

▶ Vehicles without smart entry & start system

Vehicles without power door lock system:

- ① Locks the door
- ② Unlocks the door

Vehicles with power door lock system:

- ① Locks all the doors
- ② Unlocks all the doors

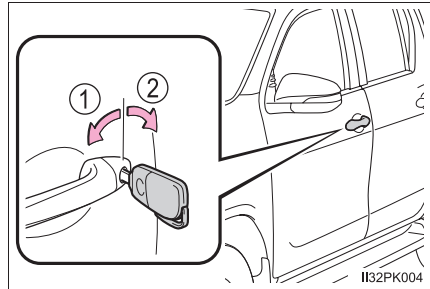

▶ Vehicles with smart entry & start system

The doors can also be locked and unlocked with the mechanical key. (→P. 603)

■ Operation signals

A buzzer (if equipped) sounds and the emergency flashers flash to indicate that the doors have been locked/unlocked using the smart entry & start system or the wireless remote control. (Locked: once; Unlocked: twice)

■ Security feature

If a door is not opened within approximately 30 seconds after the vehicle is unlocked using the smart entry & start system or the wireless remote control, the security feature automatically locks the vehicle again.

■ Door lock buzzer (vehicles with wireless remote control and smart entry & start system)

If an attempt to lock the doors is made when a door is not fully closed, a buzzer sounds continuously for 5 seconds. Fully close the door to stop the buzzer, and lock the vehicle once more.

■ If the entry function (vehicles with smart entry & start system) or the wireless remote control (if equipped) does not operate properly

- Vehicles without smart entry & start system: Use the key to lock and unlock the doors. (→P. 161)
- Vehicles with smart entry & start system: Use the mechanical key to lock and unlock the doors. (→P. 603)
- Replace the battery with a new one if it is depleted. (→P. 532)

■ Setting the alarm (if equipped)

Locking the doors will set the alarm system. (→P. 116)

■ If a symbol indicating one or more doors are open is shown on the multi-information display (if equipped)

One or more of the doors is not fully closed. The system also indicates which doors are not fully closed. If the vehicle reaches a speed of 5 km/h (3 mph), master warning light flashes and a buzzer sounds to indicate that the door(s) are not yet fully closed.

Make sure that all the doors are closed.

Locking and unlocking the doors from inside

◆ Door lock switch (if equipped)

- ① Locks all the doors
- ② Unlocks all the doors

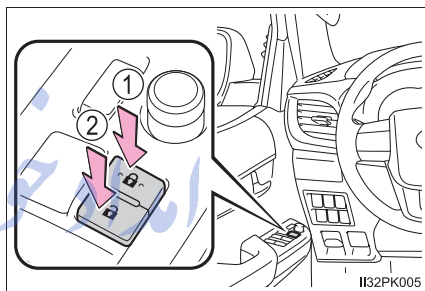

◆ Inside lock button

- ① Locks the door
- ② Unlocks the door

The driver's door can be opened by pulling the inside handle even if the lock button is in the lock position.

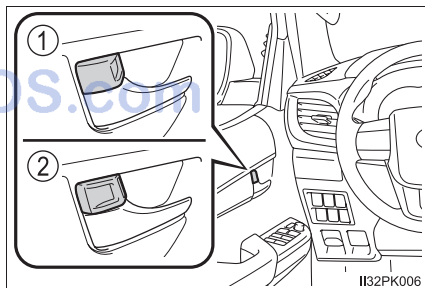

Locking the front doors from the outside without a key

- 1 Move the inside lock button to the lock position.
- 2 Close the door while pulling the door handle.

Vehicles without smart entry & start system (vehicles with power door lock system): The driver's door cannot be locked if either of the door is open and the key is in the engine switch.

Vehicles with smart entry & start system: The door cannot be locked if the engine switch is in ACCESSORY or IGNITION ON mode, or the electronic key is left inside the vehicle.

However, the key may not be detected correctly and the door may be locked.

Rear door child-protector lock (double-cab models only)

The door cannot be opened from inside the vehicle when the lock is set.

- 1 Unlock
- 2 Lock

These locks can be set to prevent children from opening the rear doors. Push down on each rear door switch to lock both rear doors.

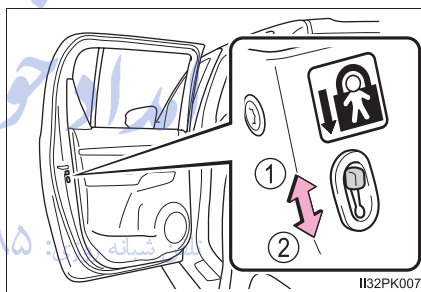

Automatic door locking and UNLOCK systems (if equipped)



The following functions can be set or canceled:

Function	Operation
Speed linked door locking function	All the doors are locked when the vehicle speed is approximately 20 km/h (12 mph) or higher. (Even if the vehicle is subject to a strong impact, all the doors will not be unlocked automatically.)
Driver's door linked door unlocking function	All the doors are unlocked when the driver's door is opened within approximately 45 seconds after turning the engine switch off.

■ Setting and canceling the functions

To switch between setting and canceling, follow the procedure below.

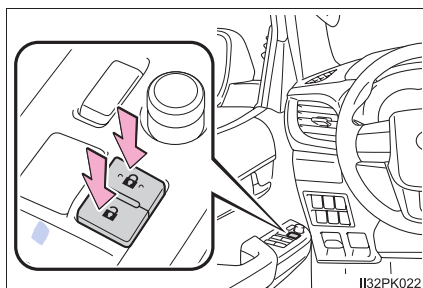

- 1 Close all the doors and turn the engine switch to IGNITION ON mode (vehicles with smart entry & start system) or the “ON” position (vehicles without smart entry & start system). (Perform step 2 within 20 seconds.)

- 2 Shift the shift lever to other than P (vehicles with automatic transmission only), and press and hold the driver's door lock switch ( or ) for approximately 5 seconds and then release.



The shift lever and switch positions corresponding to the desired function to be set are shown in the following table.

Use the same procedure to cancel the function.

Function	Driver's door lock switch position
Speed linked door locking function	
Driver's door linked door unlocking function	

When the setting or canceling operation is complete, all the doors are locked and then unlocked.

■ Conditions affecting operation

▶ Vehicles without smart entry & start system

The wireless remote control function may not operate normally in the following situations:

- Near a TV tower, radio station, electric power plant, airport or other facility that generates strong radio waves
- When carrying a portable radio, cellular phone or other wireless communication device
- When multiple wireless keys are in the vicinity
- When the wireless key is in contact with, or is covered by a metallic object
- When a wireless key (that emits radio waves) is being used nearby
- When the wireless key has been left near an electrical appliance such as a personal computer

▶ Vehicles with smart entry & start system

→P. 173

⚠ WARNING

■ To prevent an accident

Observe the following precautions while driving the vehicle.

Failing to do so may result in a door opening and an occupant falling out, resulting in death or serious injury.

- Ensure that all doors are properly closed and locked.

- Do not pull the inside handle of the doors while driving.

Be especially careful for the driver's door, as the door may be opened even if the inside lock button is in locked position.

- Set the rear door child-protector locks when children are seated in the rear seats.

Access panels (smart-cab models only)

The access panels (rear door) can be opened using the inside handle.

- 1 Open the front door widely.
- 2 Pull (from the outside) or push (from the inside) the inside handle of the access panels.

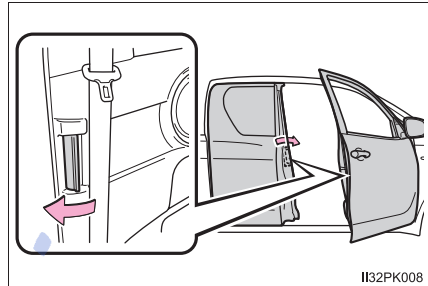

- 3 Open the access panels.

You can open and close the access panels only when the front door is widely opened.



NOTICE

■ **When opening or closing the front door and access panels**

The front door and access panels could be damaged if they hit each other when being opened or closed.

Tailgate*

The tailgate can be locked/unlocked and opened by the following procedures.

Locking and unlocking the tailgate (vehicles with key hole)

- ① Lock with the master key or the mechanical key
- ② Unlock with the master key or the mechanical key

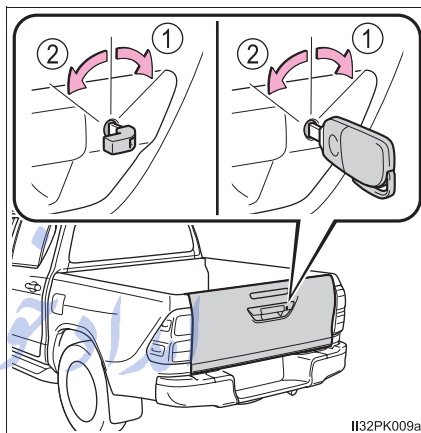

Opening the tailgate

► Type A

Unlock the latches and open the tailgate slowly.

The support stays will hold the tailgate horizontal.

After closing the tailgate, try pulling it toward you to make sure it is securely locked.

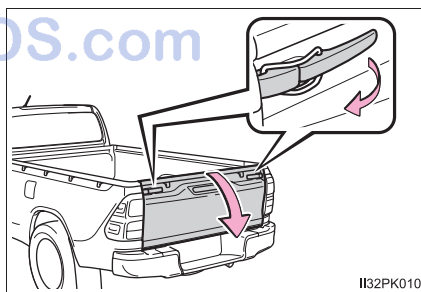

*: If equipped

► Type B

Pull the handle and open the tailgate slowly.

The support stays will hold the tailgate horizontal.

After closing the tailgate, try pulling it toward you to make sure it is securely locked.

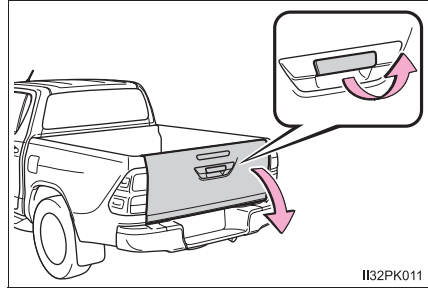

II32PK011

Lowering the tailgate

Release the brackets on the support stays from the lugs on both sides as shown in the illustration.

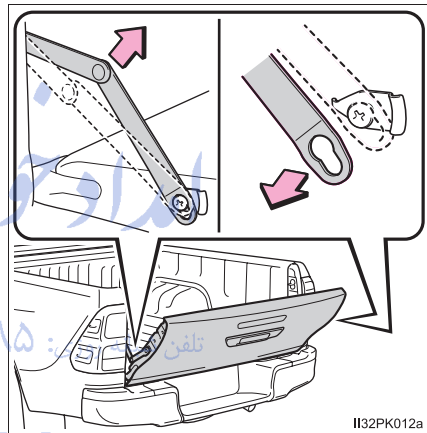

II32PK012a

Rear step bumper (if equipped)

The rear step bumper is for rear end protection and easier step-up loading.

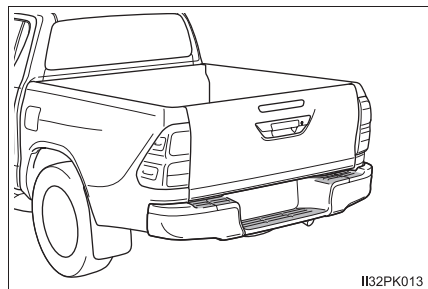

II32PK013

 WARNING**■ Caution while driving**

Observe the following precautions.
Failure to do so may result in death or serious injury.

- Do not drive with the tailgate open.
- Do not get on the rear step bumper.

 NOTICE**■ After closing the tailgate**

Try pulling it toward you to make sure it is securely locked.

■ To prevent damage to the rear step bumper

Do not allow more than one person to get on the rear step bumper at a time.

امداد خودرو فارما

تلفن شبانه روزی: ۰۲۱-۸۸۸۶۲۰۸۵

FarmaSOS.com

Smart entry & start system*

The following operations can be performed simply by carrying the electronic key on your person, for example in your pocket. The driver should always carry the electronic key.

- Locks and unlocks the doors (→P. 160)
- Starts and stops the engine (→P. 239)

■ Antenna location

- ① Antennas outside the cabin
- ② Antennas inside the cabin

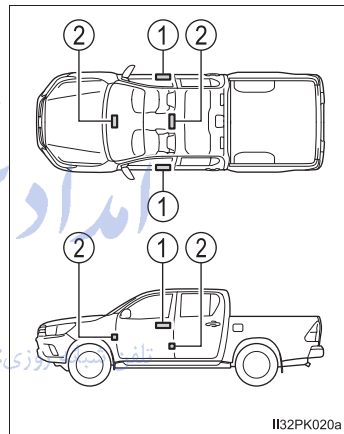

FarmaSOS.com

*: If equipped

■ Effective range (areas within which the electronic key is detected)

- When locking or unlocking the doors

The system can be operated when the electronic key is within about 0.7 m (2.3 ft.) of either of the lock/unlock button on the outside door handle. (Only the doors detecting the key can be operated.)

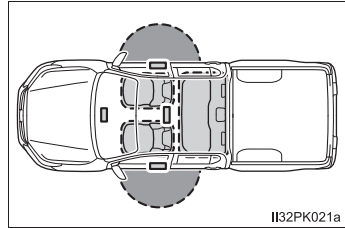

II32PK021a

- When starting the engine or changing engine switch modes



The system can be operated when the electronic key is inside the vehicle. (The electronic key is not detected when it is on the floor or on the instrument panel.)

■ Battery-saving function

The battery-saving function will be activated in order to prevent the electronic key battery and the battery from being discharged while the vehicle is not in operation for a long time.

■ Electronic Key Battery-Saving Function

When battery-saving mode is set, battery depletion is minimized by stopping the electronic key from receiving radio waves.

Press  twice while pressing and holding . Confirm that the electronic key indicator flashes 4 times. While the battery-saving mode is set, the smart entry & start system cannot be used. To cancel the function, press any of the electronic key buttons.

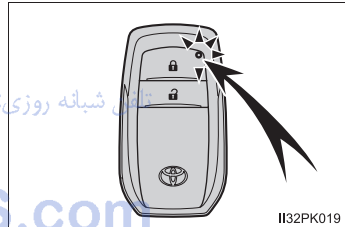

II32PK019

■ Alarms and warning indicators

A combination of exterior and interior alarms as well as warning messages shown on the multi-information display are used to prevent theft of the vehicle and accidents resulting from erroneous operation. Take appropriate measures in response to any warning message on the multi-information display.

The following table describes circumstances and correction procedures when only alarms are sounded.

Alarm	Situation	Correction procedure
Exterior alarm sounds once for 5 seconds	An attempt was made to lock the vehicle while a door was open.	Close all of the doors and lock the doors again.
Interior alarm pings continuously	The engine switch was turned to ACCESSORY mode while the driver's door was open (or the driver's door was opened while the engine switch was in ACCESSORY mode).	Turn the engine switch off and close the driver's door.

تلفن شبانه روزی: ۰۲۱-۸۸۸۶۲۰۸۵

FarmaSOS.com

■ Conditions affecting operation

The smart entry & start system uses weak radio waves. In the following situations, the communication between the electronic key and the vehicle may be affected, preventing the smart entry & start system, wireless remote control and engine immobilizer system from operating properly.

(Ways of coping: →P. 603)

- When the electronic key battery is depleted
- Near a TV tower, electric power plant, gas station, radio station, large display, airport or other facility that generates strong radio waves or electrical noise
- When carrying a portable radio, cellular phone, cordless phone or other wireless communication device
- When the electronic key is in contact with, or is covered by the following metallic objects
 - Cards to which aluminum foil is attached
 - Cigarette boxes that have aluminum foil inside
 - Metallic wallets or bags
 - Coins
 - Hand warmers made of metal
 - Media such as CDs and DVDs
- When multiple electronic keys are in the vicinity
- When other wireless keys (that emit radio waves) are being used nearby
- When carrying the electronic key together with the following devices that emit radio waves
 - Another vehicle's electronic key or a wireless key that emits radio waves
 - Personal computers or personal digital assistants (PDAs)
 - Digital audio players
 - Portable game systems
- If window tint with a metallic content or metallic objects are attached to the rear window
- When the electronic key is placed near a battery charger or electronic devices

■ Note for the entry function

- Even if the electronic key is within the effective range (detection areas) when locking or unlocking the doors, the system may not operate properly if the electronic key is too close to the window or outside door handle, near the ground, or in a high place.
- Do not leave the electronic key on top of the instrument panel or near the door pockets when exiting the vehicle. Depending on the radio wave reception conditions, it may be detected by the antenna outside the cabin and the doors will become lockable from the outside, possibly trapping the electronic key inside the vehicle.
- As long as the electronic key is within the effective range, the doors may be locked or unlocked by anyone. However, only the doors detecting the electronic key can be used to unlock the vehicle.
- Even if the electronic key is not inside the vehicle, it may be possible to start the engine if the electronic key is near the window.
- If the wireless remote control is used to lock the doors when the electronic key is near the vehicle, there is a possibility that the door may not be unlocked by the entry function. (Use the wireless remote control to unlock the doors.)
- Pulling the outside door handle while pressing the lock/unlock button on the outside door handle may prevent the doors from being unlocked. In this case, return the door handle to the original position, press the lock/unlock button again, and check that the doors unlock before pulling the door handle again.
- Unlocking the vehicle may take more time if another electronic key is within the effective range.

■ When the vehicle is not driven for extended periods

- To prevent theft of the vehicle, do not leave the electronic key within 2 m (6 ft.) of the vehicle.
- The smart entry & start system can be deactivated in advance. Ask any authorized Toyota dealer or repairer, or another duly qualified and equipped professional for details.

■ To operate the system properly

Make sure to carry the electronic key when operating the system. Do not get the electronic key too close to the vehicle when operating the system from the outside of the vehicle.

Depending on the position and holding condition of the electronic key, the key may not be detected correctly and the system may not operate properly. (The alarm may go off accidentally, or the door lock prevention function may not operate.)

■ If the smart entry & start system does not operate properly

- Locking and unlocking the doors: Use the mechanical key. (→P. 603)
- Starting the engine: →P. 604

■ Electronic key battery depletion

- The standard battery life is 1 to 2 years.
- If the battery becomes low, an alarm will sound in the cabin when the engine stops.
- As the electronic key always receives radio waves, the battery will become depleted even if the electronic key is not used. The following symptoms indicate that the electronic key battery may be depleted. Replace the battery when necessary. (→P. 532)
 - The smart entry & start system or the wireless remote control does not operate.
 - The detection area becomes smaller.
 - The LED indicator on the key surface does not turn on.
- To avoid serious deterioration, do not leave the electronic key within 1 m (3 ft.) of the following electrical appliances that produce a magnetic field:
 - TVs
 - Personal computers
 - Cellular phones, cordless phones and battery chargers
 - Recharging cellular phones or cordless phones
 - Table lamps
 - Induction cookers

■ If “KEY LEFT INSIDE VEHICLE”/“Key left inside vehicle” is shown on the multi-information display (if equipped)

An attempt was made to lock the doors using the smart entry & start system while the electronic key was still inside the vehicle, or an attempt was made to lock either front door by opening a door and putting the inside lock button into the lock position, then closing the door by pulling on the outside door handle with the electronic key still inside the vehicle.

Retrieve the electronic key from the vehicle and lock the doors again.

■ Customization that can be configured at any authorized Toyota dealer or repairer, or another duly qualified and equipped professional

Settings (e.g. smart entry & start system) can be changed.
(Customizable features: →P. 648)

■ If the smart entry & start system has been deactivated in a customized setting

- Locking and unlocking the doors:
Use the wireless remote control or mechanical key. (→P. 160, 603)
- Starting the engine and changing engine switch modes: →P. 604
- Stopping the engine: →P. 241

■ Certification for smart entry & start system

<p>Hereby, Tokai Rika Co., Ltd., declares that this BE2UM is in compliance with the essential requirements and other relevant provisions of Directives 1999/5/EC.</p>
<p>Tokai Rika Co., Ltd. vakuuttaa täten että BE2UM tyyppinen laite on direktiivin 1999/5/EY oleellisten vaatimusten ja sitä koskevien direktiivin muiden ehtojen mukainen.</p>
<p>Hierbij verklaart Tokai Rika Co., Ltd. dat het toestel BE2UM in overeenstemming is met de essentiële eisen en de andere relevante bepalingen van richtlijn 1999/5/EG.</p>
<p>Par la présente Tokai Rika Co., Ltd. déclare que l'appareil BE2UM est conforme aux exigences essentielles et aux autres dispositions pertinentes de la directive 1999/5/CE.</p>
<p>Härmed intygar Tokai Rika Co., Ltd. att denna BE2UM står i överensstämmelse med de väsentliga egenskapskrav och övriga relevanta bestämmelser som framgår av direktiv 1999/5/EG.</p>
<p>Undertegnede Tokai Rika Co., Ltd. erklærer herved, at følgende udstyr BE2UM overholder de væsentlige krav og øvrige relevante krav i direktiv 1999/5/EF.</p>
<p>Hiermit erklärt Tokai Rika Co., Ltd., dass sich das Gerät BE2UM in Übereinstimmung mit den grundlegenden Anforderungen und den übrigen einschlägigen Bestimmungen der Richtlinie 1999/5/EG befindet.</p>
<p>ΜΕ ΤΗΝ ΠΑΡΟΥΣΑ Tokai Rika Co., Ltd. ΔΗΛΩΝΕΙ ΟΤΙ ΒΕ2UM ΣΥΜΜΟΡΦΩΝΕΤΑΙ ΠΡΟΣ ΤΙΣ ΟΥΣΙΩΔΕΙΣ ΑΠΑΙΤΗΣΕΙΣ ΚΑΙ ΤΙΣ ΛΟΙΠΕΣ ΣΧΕΤΙΚΕΣ ΔΙΑΤΑΞΕΙΣ ΤΗΣ ΟΔΗΓΙΑΣ 1999/5/ΕΚ.</p>
<p>Con la presente Tokai Rika Co., Ltd. dichiara che questo BE2UM è conforme ai requisiti essenziali ed alle altre disposizioni pertinenti stabilite dalla direttiva 1999/5/CE.</p>
<p>Por medio de la presente Tokai Rika Co., Ltd. declara que el BE2UM cumple con los requisitos esenciales y cualesquiera otras disposiciones aplicables o exigibles de la Directiva 1999/5/CE.</p>
<p>Tokai Rika Co., Ltd. declara que este BE2UM está conforme com os requisitos essenciais e outras disposições da Directiva 1999/5/CE.</p>

Hawnekk, Tokai Rika Co., Ltd., jiddikjara li dan BE2UM jikkonforma mal-ħtiġijiet essenzjali u ma provvedimenti oħrajn relevanti li hemm fid-Dirrettiva 1999/5/EC.
Käesolevaga kinnitab Tokai Rika Co., Ltd. seadme BE2UM vastavust direktiivi 1999/5/EÜ põhinõuetele ja nimetatud direktiivist tulenevatele teistele asjakohastele sätetele.
Alulírott, Tokai Rika Co., Ltd. nyilatkozom, hogy a BE2UM megfelel a vonatkozó alapvető követelményeknek és az 1999/5/EC irányelv egyéb előírásainak.
Tokai Rika Co., Ltd. týmto vyhlasuje, že BE2UM spĺňa základné požiadavky a všetky príslušné ustanovenia Smernice 1999/5/ES.
Tokai Rika Co., Ltd. tímto prohlašuje, že tento BE2UM je ve shodě se základními požadavky a dalšími příslušnými ustanoveními směrnice 1999/5/ES.
Tokai Rika Co., Ltd. izjavlja, da je ta BE2UM v skladu z bistvenimi zahtevami in ostalimi relevantnimi določili direktive 1999/5/ES.
Šiuo Tokai Rika Co., Ltd. deklaruoją, kad šis BE2UM atitinka esminius reikalavimus ir kitas 1999/5/EB Direktyvos nuostatas.
Ar šo Tokai Rika Co., Ltd. deklarē, ka BE2UM atbilst Direktīvas 1999/5/EK būtiskajām prasībām un citiem ar to saistītajiem noteikumiem.
Niniejszym Tokai Rika Co., Ltd. oświadcza, że BE2UM jest zgodny z zasadniczymi wymogami oraz pozostałymi stosownymi postanowieniami Dyrektywy 1999/5/EC.
Hér með lýsir Tokai Rika Co., Ltd. yfir því að BE2UM er í samræmi við grunnkröfur og aðrar kröfur, sem gerðar eru í tilskipun 1999/5/EC.
Tokai Rika Co., Ltd. erklærer herved at utstyret BE2UM er i samsvar med de grunnleggende krav og øvrige relevante krav i direktiv 1999/5/EF.
С настоящето, Tokai Rika Co., Ltd., декларира, че BE2UM е в съответствие със съществените изисквания и другите приложими разпоредби на Директива 1999/5/EC.

Prin prezenta, Tokai Rika Co., Ltd., declară că aparatul BE2UM este in conformitate cu cerințele esențiale și cu alte prevederi pertinente ale Directivei 1999/5/CE.
Ovim, Tokai Rika Co., Ltd., izjavljuje da ovaj BE2UM je usklađen sa bitnim zahtjevima i drugim relevantnim odredbama Direktive 1999/5/EC.
Nepermjet kesaj, Tokai Rika Co., Ltd., deklaroi qe ky BE2UM eshte ne pajtim me kerkesat thelbesore dhe dispozitat e tjera perkatese te Direktives 1999/5/EC.
Ovim Tokai Rika Co., Ltd., izjavljuje da je BE2UM u sklau s bitnim zahtjevima i drugim relevantnim odredbama Direktive 1999/5/EC i Pravilnika o RiTT opremi (NN 25/2012).
Ovim, Tokai Rika Co., Ltd., deklarise da je BE2UM u skladu sa osnovnim zahtevima i ostalim relevantnim odredbama Direktive 1999/5/EC.

The DECLARATION of CONFORMITY (DoC) is available at the following address:

<http://www.tokai-rika.co.jp/pc>



تلفن شبانه روزی: ۰۲۱-۸۸۸۶۲۰۸۵

FarmaSOS.com

<p>Hereby, Tokai Rika Co., Ltd., declares that this BM1EW is in compliance with the essential requirements and other relevant provisions of Directives 1999/5/EC.</p>
<p>Tokai Rika Co., Ltd. vakuuttaa täten että BM1EW tyyppinen laite on direktiivin 1999/5/EY oleellisten vaatimusten ja sitä koskevien direktiivin muiden ehtojen mukainen.</p>
<p>Hierbij verklaart Tokai Rika Co., Ltd. dat het toestel BM1EW in overeenstemming is met de essentiële eisen en de andere relevante bepalingen van richtlijn 1999/5/EG.</p>
<p>Par la présente Tokai Rika Co., Ltd. déclare que l'appareil BM1EW est conforme aux exigences essentielles et aux autres dispositions pertinentes de la directive 1999/5/CE.</p>
<p>Härmed intygar Tokai Rika Co., Ltd. att denna BM1EW står i överensstämmelse med de väsentliga egenskapskrav och övriga relevanta bestämmelser som framgår av direktiv 1999/5/EG.</p>
<p>Undertegnede Tokai Rika Co., Ltd. erklærer herved, at følgende udstyr BM1EW overholder de væsentlige krav og øvrige relevante krav i direktiv 1999/5/EF.</p>
<p>Hiermit erklärt Tokai Rika Co., Ltd., dass sich das Gerät BM1EW in Übereinstimmung mit den grundlegenden Anforderungen und den übrigen einschlägigen Bestimmungen der Richtlinie 1999/5/EG befindet.</p>
<p>ΜΕ ΤΗΝ ΠΑΡΟΥΣΑ Tokai Rika Co., Ltd. ΔΗΛΩΝΕΙ ΟΤΙ ΒΜ1ΕW ΣΥΜΜΟΡΦΩΝΕΤΑΙ ΠΡΟΣ ΤΙΣ ΟΥΣΙΩΔΕΙΣ ΑΠΑΙΤΗΣΕΙΣ ΚΑΙ ΤΙΣ ΛΟΙΠΕΣ ΣΧΕΤΙΚΕΣ ΔΙΑΤΑΞΕΙΣ ΤΗΣ ΟΔΗΓΙΑΣ 1999/5/ΕΚ.</p>
<p>Con la presente Tokai Rika Co., Ltd. dichiara che questo BM1EW è conforme ai requisiti essenziali ed alle altre disposizioni pertinenti stabilite dalla direttiva 1999/5/CE.</p>
<p>Por medio de la presente Tokai Rika Co., Ltd. declara que el BM1EW cumple con los requisitos esenciales y cualesquiera otras disposiciones aplicables o exigibles de la Directiva 1999/5/CE.</p>
<p>Tokai Rika Co., Ltd. declara que este BM1EW está conforme com os requisitos essenciais e outras disposições da Directiva 1999/5/CE.</p>

Hawnhekk, Tokai Rika Co., Ltd., jiddikjara li dan BM1EW jikkonforma mal-ħtiġijiet essenzjali u ma provvedimenti oħrajn relevanti li hemm fid-Dirrettiva 1999/5/EC.
Käesolevaga kinnitab Tokai Rika Co., Ltd. seadme BM1EW vastavust direktiivi 1999/5/EÜ põhinõuetele ja nimetatud direktiivist tulenevatele teistele asjakohastele sätetele.
Alulírott, Tokai Rika Co., Ltd. nyilatkozom, hogy a BM1EW megfelel a vonatkozó alapvető követelményeknek és az 1999/5/EC irányelv egyéb előírásainak.
Tokai Rika Co., Ltd. týmto vyhlasuje, že BM1EW spĺňa základné požiadavky a všetky príslušné ustanovenia Smernice 1999/5/ES.
Tokai Rika Co., Ltd. tímto prohlašuje, že tento BM1EW je ve shodě se základními požadavky a dalšími příslušnými ustanoveními směrnice 1999/5/ES.
Tokai Rika Co., Ltd. izjavlja, da je ta BM1EW v skladu z bistvenimi zahtevami in ostalimi relevantnimi določili direktive 1999/5/ES.
Šiuo Tokai Rika Co., Ltd. deklaruoja, kad šis BM1EW atitinka esminius reikalavimus ir kitas 1999/5/EB Direktyvos nuostatas.
Ar šo Tokai Rika Co., Ltd. deklarē, ka BM1EW atbilst Direktīvas 1999/5/EK būtiskajām prasībām un citiem ar to saistītajiem noteikumiem.
Niniejszym Tokai Rika Co., Ltd. oświadcza, że BM1EW jest zgodny z zasadniczymi wymogami oraz pozostałymi stosownymi postanowieniami Dyrektywy 1999/5/EC.
Hér með lýsir Tokai Rika Co., Ltd. yfir því að BM1EW er í samræmi við grunnkröfur og aðrar kröfur, sem gerðar eru í tilskipun 1999/5/EC.
Tokai Rika Co., Ltd. erklærer herved at utstyret BM1EW er i samsvar med de grunnleggende krav og øvrige relevante krav i direktiv 1999/5/EF.
С настоящето, Tokai Rika Co., Ltd., декларира, че BM1EW е в съответствие със съществените изисквания и другите приложими разпоредби на Директива 1999/5/EC.

<p>Prin prezenta, Tokai Rika Co., Ltd., declară că aparatul BM1EW este în conformitate cu cerințele esențiale și cu alte prevederi pertinente ale Directivei 1999/5/CE.</p>
<p>Ovim, Tokai Rika Co., Ltd., izjavljuje da ovaj BM1EW je usklađen sa bitnim zahtjevima i drugim relevantnim odredbama Direktive 1999/5/EC.</p>
<p>Nepermjet kesaj, Tokai Rika Co., Ltd., deklaroj qe ky BM1EW eshte ne pajtim me kerkesat thelbesore dhe dispozitat e tjera perkatese te Direktives 1999/5/EC.</p>
<p>Ovim Tokai Rika Co., Ltd., izjavljuje da je BM1EW u skladu s bitnim zahtjevima i drugim relevantnim odredbama Direktive 1999/5/EC i Pravilnika o RiTT opremi (NN 25/2012).</p>
<p>Ovim, Tokai Rika Co., Ltd., deklarirše da je BM1EW u skladu sa osnovnim zahtevima i ostalim relevantnim odredbama Direktive 1999/5/EC.</p>

The DECLARATION of CONFORMITY (DoC) is available at the following address:

<http://www.tokai-rika.co.jp/pc>



تلفن شبانه روزی: ۰۲۱-۸۸۸۶۲۰۸۵

FarmaSOS.com

TOYOTA

TOYOTA MOTOR CORPORATION

1, TOYOTA-CHO, TOYOTA, AICHI, 471-8571, JAPAN TEL: +81-565-28-2121

R&TTE Declaration of Conformity

We,

Manufacturer's Name: TOYOTA MOTOR CORPORATION

Manufacturer's Address: 1, Toyota -cho, Toyota, Aichi, 471-8572, Japan

hereby declare under our sole responsibility that the product:

Product Name: LF Oscillator

Product Model: TS-9TY

to which this declaration relates is in conformity with the essential requirements and other relevant requirements of the R&TTE Directive (1999/5/EC). The product is compliant with the following standards and/or other normative documents:

- Health & safety requirements: EN 60950-1
- EMC requirements: EN 301 489-01 & EN 301 489-03
- Effective uses of radio spectrum: EN 300 330-2

Supplementary information:

* CE mark	
* Member states intended for use	EU and EFTA

Date: June 24, 2014

Signature: *Hiroki Okada*
Hiroki Okada

<p>Hereby, Toyota Motor Corporation, declares that this TS-9TY is in compliance with the essential requirements and other relevant provisions of Directive 1999/5/EC.</p>
<p>Toyota Motor Corporation vakuuttaa täten että TS-9TY tyyppinen laite on direktiivin 1999/5/EY oleellisten vaatimusten ja sitä koskevien direktiivin muiden ehtojen mukainen.</p>
<p>Hierbij verklaart Toyota Motor Corporation dat het toestel TS-9TY in overeenstemming is met de essentiële eisen en de andere relevante bepalingen van richtlijn 1999/5/EG.</p>
<p>Par la présente Toyota Motor Corporation déclare que l'appareil TS-9TY est conforme aux exigences essentielles et aux autres dispositions pertinentes de la directive 1999/5/CE.</p>
<p>Härmed intygar Toyota Motor Corporation att denna TS-9TY står i överensstämmelse med de väsentliga egenskapskrav och övriga relevanta bestämmelser som framgår av direktiv 1999/5/EG.</p>
<p>Undertegnede Toyota Motor Corporation erklærer herved, at følgende udstyr TS-9TY overholder de væsentlige krav og øvrige relevante krav i direktiv 1999/5/EF.</p>
<p>Hiermit erklärt Toyota Motor Corporation, dass sich das Gerät TS-9TY in Übereinstimmung mit den grundlegenden Anforderungen und den übrigen einschlägigen Bestimmungen der Richtlinie 1999/5/EG befindet.</p>
<p>ΜΕ ΤΗΝ ΠΑΡΟΥΣΑ Toyota Motor Corporation ΔΗΛΩΝΕΙ ΟΤΙ ΤS-9TY ΣΥΜΜΟΡΦΩΝΕΤΑΙ ΠΡΟΣ ΤΙΣ ΟΥΣΙΩΔΕΙΣ ΑΠΑΙΤΗΣΕΙΣ ΚΑΙ ΤΙΣ ΛΟΙΠΕΣ ΣΧΕΤΙΚΕΣ ΔΙΑΤΑΞΕΙΣ ΤΗΣ ΟΔΗΓΙΑΣ 1999/5/ΕΚ.</p>
<p>Con la presente Toyota Motor Corporation dichiara che questo TS-9TY è conforme ai requisiti essenziali ed alle altre disposizioni pertinenti stabilite dalla direttiva 1999/5/CE.</p>
<p>Por medio de la presente Toyota Motor Corporation declara que el TS-9TY cumple con los requisitos esenciales y cualesquiera otras disposiciones aplicables o exigibles de la Directiva 1999/5/CE.</p>
<p>Toyota Motor Corporation declara que este TS-9TY está conforme com os requisitos essenciais e outras disposições da Directiva 1999/5/CE.</p>

<p>Hawnhekk, Toyota Motor Corporation, jiddikjara li dan TS-9TY jikkonforma mal-ħtiġijiet essenzjali u ma provvedimenti oħrajn relevanti li hemm fid-Dirrettiva 1999/5/EC.</p>
<p>Käesolevaga kinnitab Toyota Motor Corporation seadme TS-9TY vastavust direktiivi 1999/5/EÜ põhinõuetele ja nimetatud direktiivist tulenevatele teistele asjakohastele sätetele.</p>
<p>Alulírott, Toyota Motor Corporation nyilatkozom, hogy a TS-9TY megfelel a vonatkozó alapvető követelményeknek és az 1999/5/EC irányelv egyéb előírásainak.</p>
<p>Toyota Motor Corporation týmto vyhlasuje, že TS-9TY spĺňa základné požiadavky a všetky príslušné ustanovenia Smernice 1999/5/ES.</p>
<p>Toyota Motor Corporation tímto prohlašuje, že tento TS-9TY je ve shodě se základními požadavky a dalšími příslušnými ustanoveními směrnice 1999/5/ES.</p>
<p>Toyota Motor Corporation izjavlja, da je ta TS-9TY v skladu z bistvenimi zahtevami in ostalimi relevantnimi določili direktive 1999/5/ES.</p>
<p>Šiuo Toyota Motor Corporation deklaruoja, kad šis TS-9TY atitinka esminius reikalavimus ir kitas 1999/5/EB Direktyvos nuostatas.</p>
<p>Ar šo Toyota Motor Corporation deklarē, ka TS-9TY atbilst Direktīvas 1999/5/EK būtiskajām prasībām un citiem ar to saistītajiem noteikumiem.</p>
<p>Niniejszym Toyota Motor Corporation oświadcza, że TS-9TY jest zgodny z zasadniczymi wymogami oraz pozostałymi stosownymi postanowieniami Dyrektywy 1999/5/EC.</p>
<p>Hér með lýsir Toyota Motor Corporation yfir því að TS-9TY er í samræmi við grunnkröfur og aðrar kröfur, sem gerðar eru í tilskipun 1999/5/EC.</p>
<p>Toyota Motor Corporation erklærer herved at utstyret TS-9TY er i samsvar med de grunnleggende krav og øvrige relevante krav i direktiv 1999/5/EF.</p>
<p>С настоящето, Toyota Motor Corporation, декларира, че TS-9TY е в съответствие със съществените изисквания и другите приложими разпоредби на Директива 1999/5/EC.</p>

Prin prezenta, Toyota Motor Corporation, declară că aparatul TS-9TY este în conformitate cu cerințele esențiale și cu alte prevederi pertinente ale Directivei 1999/5/CE.
Ovim, Toyota Motor Corporation, izjavljuje da ovaj TS-9TY je usklađen sa bitnim zahtjevima i drugim relevantnim odredbama Direktive 1999/5/EC.
Nepermjet kesaj, Toyota Motor Corporation, deklaroi qe ky TS-9TY eshte ne pajtim me kerkesat thelbesore dhe dispozitat e tjera perkatese te Direktives 1999/5/EC.
Ovim Toyota Motor Corporation, izjavljuje da je TS-9TY u skladu s bitnim zahtjevima i drugim relevantnim odredbama Direktive 1999/5/EC i Pravilnika o RiTT opremi (NN 25/2012).
Ovim, Toyota Motor Corporation, deklarirše da je TS-9TY u skladu sa osnovnim zahtevima i ostalim relevantnim odredbama Direktive 1999/5/EC.

 **WARNING**

Caution regarding interference with electronic devices

- People with implantable cardiac pacemakers, cardiac resynchronization therapy-pacemakers or implantable cardioverter defibrillators should maintain a reasonable distance between themselves and the smart entry & start system antennas. (→P. 170)

The radio waves may affect the operation of such devices. If necessary, the entry function can be disabled. Ask any authorized Toyota dealer or repairer, or another duly qualified and equipped professional for details, such as the frequency of radio waves and timing of the emitting radio waves. Then, consult your doctor to see if you should disable the entry function.

- Users of any electrical medical device other than implantable cardiac pacemakers, cardiac resynchronization therapy-pacemakers or implantable cardioverter defibrillators should consult the manufacturer of the device for information about its operation under the influence of radio waves.

Radio waves could have unexpected effects on the operation of such medical devices.

Ask any authorized Toyota dealer or repairer, or another duly qualified and equipped professional for details on disabling the entry function.

Front seats

Adjustment procedure

► Manual seat (separated type)

- ① Seat position adjustment lever
- ② Seatback angle adjustment lever
- ③ Vertical height adjustment lever (if equipped for driver's seat only)

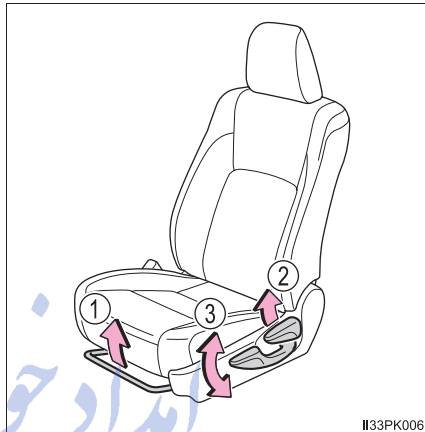

► Manual seat (bench type)

- ① Seat position adjustment lever (driver's seat only)
- ② Seatback angle adjustment lever

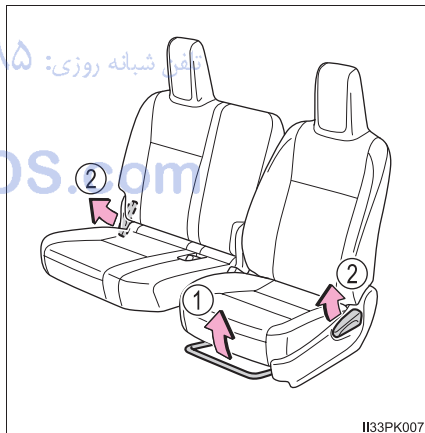

► Power seat (driver's seat only)

- ① Seat position adjustment switch
- ② Seatback angle adjustment switch
- ③ Seat cushion (front) angle adjustment switch
- ④ Vertical height adjustment switch



⚠ WARNING

■ **When adjusting the seat position**

- Take care when adjusting the seat position to ensure that other passengers are not injured by the moving seat.
- Do not put your hands under the seat or near the moving parts to avoid injury.
Fingers or hands may become jammed in the seat mechanism.

■ **Seat adjustment**

- To reduce the risk of sliding under the lap belt during a collision, do not recline the seat more than necessary.
If the seat is too reclined, the lap belt may slide past the hips and apply restraint forces directly to the abdomen, or your neck may contact the shoulder belt, increasing the risk of death or serious injury in the event of an accident.
Adjustments should not be made while driving as the seat may unexpectedly move and cause the driver to lose control of the vehicle.
- Manual seat: After adjusting the seat, make sure that the seat is locked in position.

Rear seats*

Removing the rear seat cushions (if equipped for smart-cab models)

- ① Unhook the lock release lever.
- ② Pull the seat cushions up and then pull toward the front of vehicle.

The seat cushions can be removed separately.

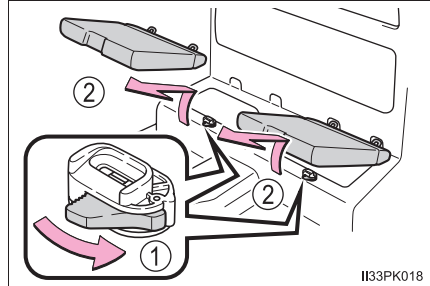

II33PK018

Raising the bottom cushion (double-cab models)

► Type A

- 1 Pull the head restraint up.

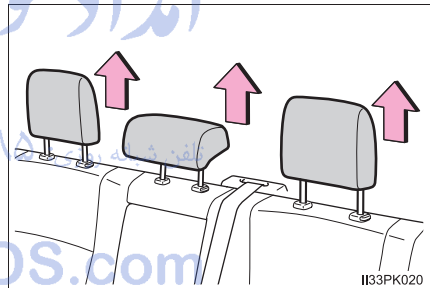

II33PK020

- 2 Pull the strap and raise the bottom cushion.

The latch under the bottom cushion will release allowing the bottom cushion to be raised.

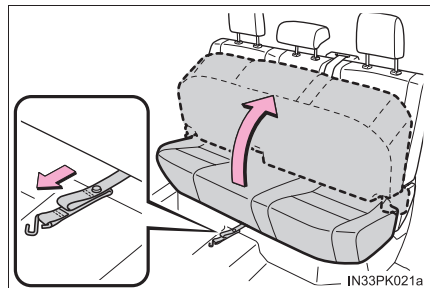

IN33PK021a

*: If equipped

- 3 Anchor the strap to the head restraint.

Vehicles without the rear center seat head restraint: Anchor the strap to the rear outboard seat head restraint.

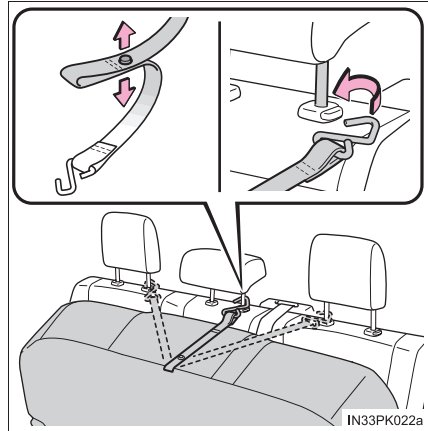

► Type B

- 1 Pull the head restraints up.

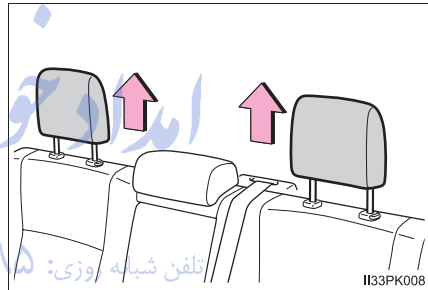

- 2 Pull the straps and raise the bottom cushions.

The latch under the bottom cushions will release allowing the bottom cushions to be raised.

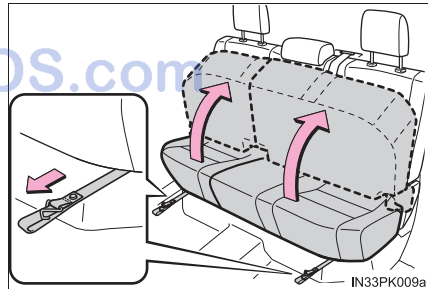

- 3 Anchor the straps to the head restraints.

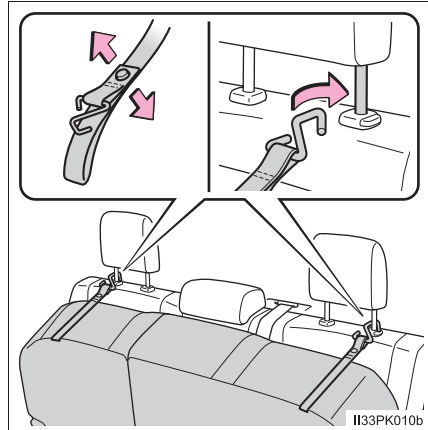

⚠ WARNING

Observe the following precautions. Failure to do so may result in death or serious injury.

■ **When removing the rear seat cushions**

- Do not remove the rear seat cushions while driving.
- Be careful not to hit the removed rear seat cushions against a person or drop it on yourself.

■ **When reinstalling the rear seat cushions or returning the bottom cushions to their original position**

- Be careful not to get your hands or feet pinched in the seat.
- Make sure there are no obstacles under the seat which would prevent the seat from properly locking into place.
- Make sure the rear seat cushions and bottom cushion are securely locked by pushing it upward and downward.
- Check that the seat belts are not twisted or caught in the bottom cushions.

Head restraints

Head restraints are provided for driver's seat, front passenger's seat, outboard rear seats and center rear seats (if equipped).

Front seats

► Adjustable type

① Up

Pull the head restraints up.

② Down

Push the head restraint down while pressing the lock release button.

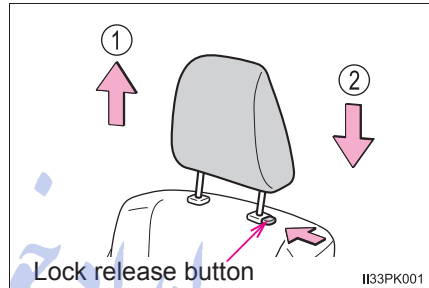

► Integrated type

Head restraints cannot be adjusted and removed.

Rear seats (if equipped)

► Adjustable type

① Up

Pull the head restraints up.

② Down

Push the head restraint down while pressing the lock release button.

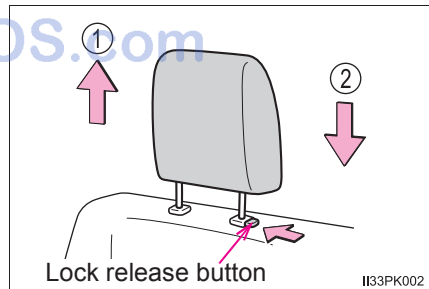

► Integrated type

Head restraints cannot be adjusted and removed.

■ Removing the head restraints

Pull the head restraint up while pressing the lock release button.

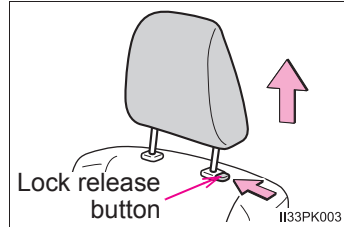

■ Installing the head restraints

Align the head restraint with the installation holes and push it down to the lock position.

Press and hold the lock release button when lowering the head restraint.

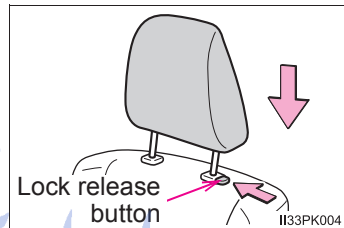

■ Adjusting the height of the head restraints

Make sure that the head restraints are adjusted so that the center of the head restraint is closest to the top of your ears.

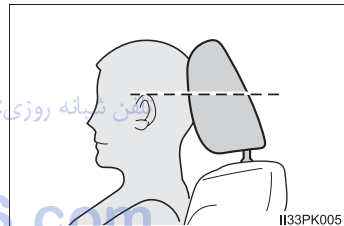

■ Adjusting the rear center seat head restraint (if equipped)

Always raise the head restraint one level from the stowed position when using.

 WARNING**■ Head restraint precautions**

Observe the following precautions regarding the head restraints. Failure to do so may result in death or serious injury.

- Use the head restraints designed for each respective seat.
- Adjust the head restraints to the correct position at all times.
- After adjusting the head restraints, push down on them and make sure they are locked in position.
- Do not drive with the head restraints removed.

امداد خودرو فارما

تلفن شبانه روزی: ۰۲۱-۸۸۸۶۲۰۸۵

FarmaSOS.com

Steering wheel

Adjustment procedure

- 1 Hold the steering wheel and push the lever down.

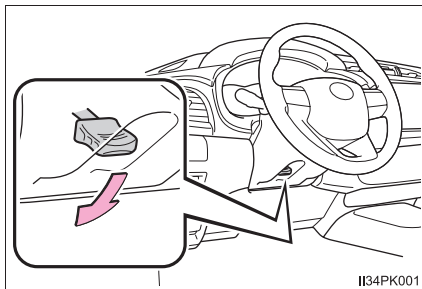

► Type A

- 2 Adjust to the ideal position by moving the steering wheel vertically.

After adjustment, pull the lever up to secure the steering wheel.

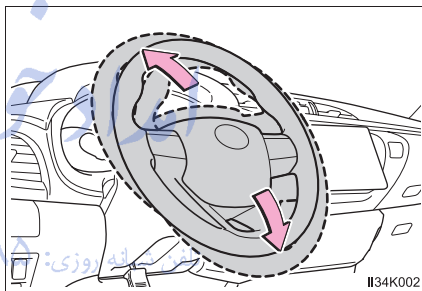

► Type B

- 2 Adjust to the ideal position by moving the steering wheel horizontally and vertically.

After adjustment, pull the lever up to secure the steering wheel.

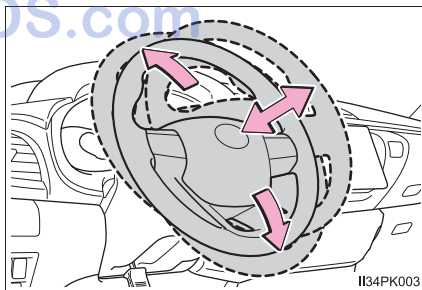

Horn

To sound the horn, press on or close to the  mark.

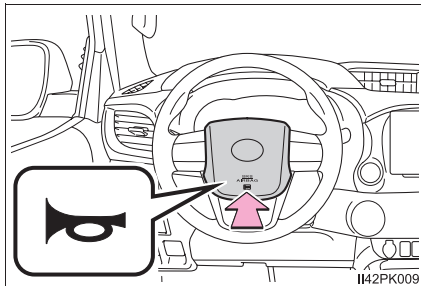

■ After adjusting the steering wheel

Make sure that the steering wheel is securely locked.

The horn may not sound if the steering wheel is not securely locked.

⚠ WARNING

■ Caution while driving

Do not adjust the steering wheel while driving.

Doing so may cause the driver to mishandle the vehicle and cause an accident, resulting in death or serious injury.

■ After adjusting the steering wheel

Make sure that the steering wheel is securely locked.

Otherwise, the steering wheel may move suddenly, possibly causing an accident, and resulting in death or serious injury.

Inside rear view mirror

The rear view mirror's position can be adjusted to enable sufficient confirmation of the rear view.

Adjusting the height of rear view mirror

The height of the rear view mirror can be adjusted to suit your driving posture.

Adjust the height of the rear view mirror by moving it up and down.

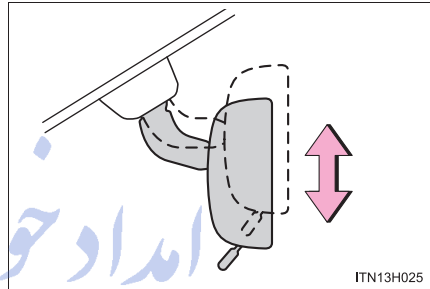

Anti-glare function

Reflected light from the headlights of vehicles behind can be reduced by operating the lever.

- ① Normal position
- ② Anti-glare position

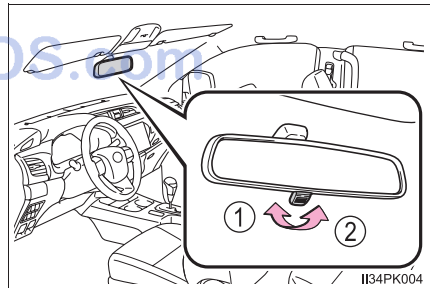

⚠ WARNING

Do not adjust the position of the mirror while driving. Doing so may lead to mishandling of the vehicle and cause an accident, resulting in death or serious injury.

Outside rear view mirrors

Adjustment procedure

► Manual adjustable type

Adjust a mirror.

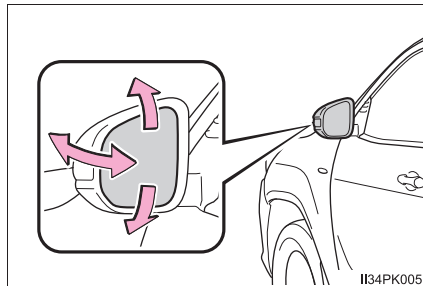

► Power adjustable type

1 To select a mirror to adjust, turn the switch.

- ① Left
- ② Right

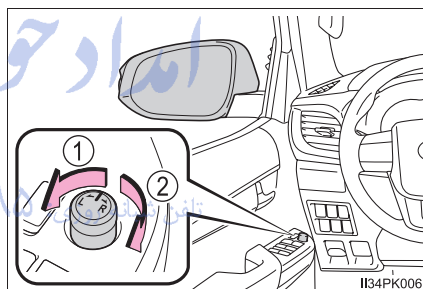

2 To adjust the mirror, move the switch.

- ① Up
- ② Right
- ③ Down
- ④ Left

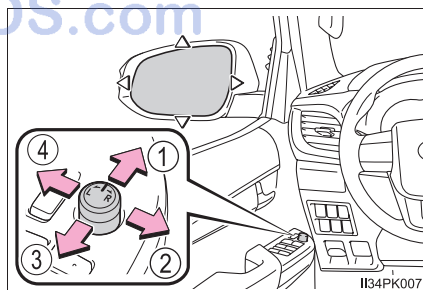

Folding the mirrors

▶ Manual folding type

Push the mirror back in the direction of the vehicle's rear.

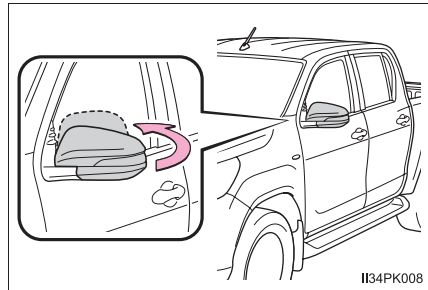

▶ Power folding type

Press the switch.

- ① Folding
- ② Extending

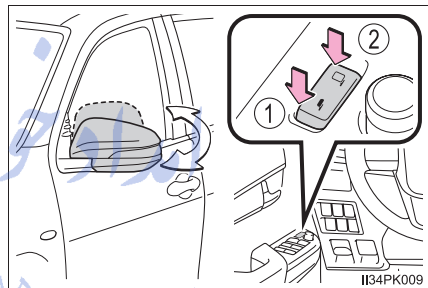

■ Mirror angle can be adjusted when (power adjustable type)

▶ Vehicles without smart entry & start system

The engine switch is in the "ACC" or "ON" position.

▶ Vehicles with smart entry & start system

The engine switch is in ACCESSORY or IGNITION ON mode.

■ When the mirrors are fogged up (vehicles with outside rear view mirror defoggers)

The outside rear view mirrors can be cleared using the mirror defoggers. Turn on the rear window defogger to turn on the outside rear view mirror defoggers. (→P. 449, 458)

 WARNING**■ Important points while driving**

Observe the following precautions while driving.

Failure to do so may result in loss of control of the vehicle and cause an accident, resulting in death or serious injury.

- Do not adjust the mirrors while driving.
- Do not drive with the mirrors folded.
- Both the driver and passenger side mirrors must be extended and properly adjusted before driving.

■ When a mirror is moving (power adjustable type)

To avoid personal injury and mirror malfunction, be careful not to get your hand caught by the moving mirror.

■ When the mirror defoggers are operating (vehicles with outside rear view mirror defoggers)

Do not touch the rear view mirror surfaces, as they can become very hot and burn you.

 NOTICE**■ If ice should jam the mirror**

Do not operate the control or scrape the mirror face. Use a spray de-icer to free the mirror.

Power windows*

Opening and closing procedures

The power windows can be opened and closed using the switches.

Operating the switch moves the windows as follows:

► Type A

- ① Closing
- ② Opening
- ③ One-touch opening*
(driver's window only)

*: To stop the window partway, operate the switch in the opposite direction.

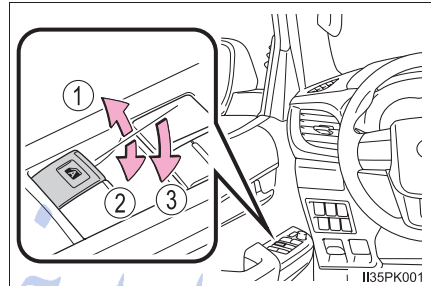

► Type B

- ① Closing
- ② Opening
- ③ One-touch opening*
(driver's window only)
- ④ One-touch closing*
(driver's window only)

*: To stop the window partway, operate the switch in the opposite direction.

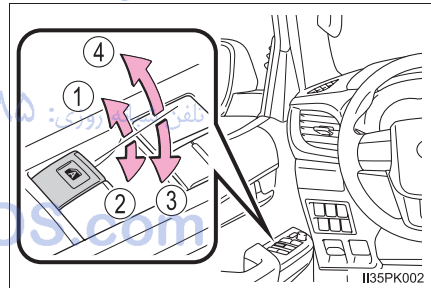

*: If equipped

► Type C

- ① Closing
- ② Opening
- ③ One-touch opening*
- ④ One-touch closing*

*: To stop the window partway, operate the switch in the opposite direction.

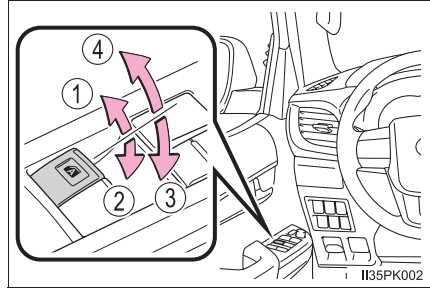

Window lock switch

Press the switch down to lock the passenger window switches.

Use this switch to prevent children from accidentally opening or closing a passenger window.

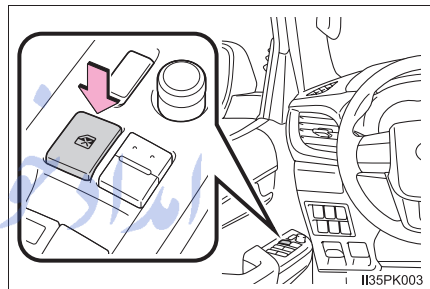

■ The power windows can be operated when

- Vehicles without smart entry & start system

The engine switch is in the "ON" position.

- Vehicles with smart entry & start system

The engine switch is in IGNITION ON mode.

■ Jam protection function (windows with one-touch function for type B and C)

If an object becomes jammed between the window and the window frame while the window is closing, window movement is stopped and the window is opened slightly.

■ Catch protection function (windows with one-touch function for type B and C)

If an object becomes caught between the door and window while the window is opening, window movement is stopped.

■ Operating the power windows after turning the engine off

▶ Vehicles without smart entry & start system

The power windows can be operated for approximately 45 seconds even after the engine switch is turned to the “ACC” or “LOCK” position. They cannot, however, be operated once either front door is opened.

▶ Vehicles with smart entry & start system

The power windows can be operated for approximately 45 seconds even after the engine switch is turned to ACCESSORY mode or turned off. They cannot, however, be operated once either front door is opened.

■ When the window cannot be opened or closed (windows with one-touch function for type B and C)

When the jam protection function or catch protection function operates unusually and the window cannot be opened or closed, perform the following operations with the power window switch of that door.

- Stop the vehicle. With the engine switch in the “ON” position (vehicles without smart entry & start system) or IGNITION ON mode (vehicles with smart entry & start system), within 4 seconds of the jam protection function or catch protection function activating, continually operate the power window switch in the one-touch closing direction or one-touch opening direction so that the window can be opened and closed.
- If the window cannot be opened and closed even when performing the above operations, perform the following procedure for function initialization.
 - 1 Turn the engine switch to the “ON” position (vehicles without smart entry & start system) or IGNITION ON mode (vehicles with smart entry & start system).
 - 2 Pull and hold the power window switch in the one-touch closing direction and completely close the window.
 - 3 Release the power window switch for a moment, resume pulling the switch in the one-touch closing direction, and hold it there for approximately 6 seconds or more.
 - 4 Press and hold the power window switch in the one-touch opening direction. After the window is completely opened, continue holding the switch for an additional 1 second or more.
 - 5 Release the power window switch for a moment, resume pushing the switch in the one-touch opening direction, and hold it there for approximately 4 seconds or more.
 - 6 Pull and hold the power window switch in the one-touch closing direction again. After the window is completely closed, continue holding the switch for a further 1 second or more.

If you release the switch while the window is moving, start again from the beginning.

If the window reverses and cannot be fully closed or opened, have the vehicle inspected by any authorized Toyota dealer or repairer, or another duly qualified and equipped professional.

 **WARNING**

Observe the following precautions.
Failure to do so may result in death or serious injury.

■ **Closing the windows**

- The driver is responsible for all the power window operations, including the operation for the passengers. In order to prevent accidental operation, especially by a child, do not let a child operate the power windows. It is possible for children and other passengers to have body parts caught in the power window. Also, when riding with a child, it is recommended to use the window lock switch. (→P. 201)
- Check to make sure that all passengers do not have any part of their body in a position where it could be caught when a window is being operated.
- When exiting the vehicle, turn the engine switch off, carry the key and exit the vehicle along with the child. There may be accidental operation, due to mischief, etc., that may possibly lead to an accident.

■ **Jam protection function (windows with one-touch function for type B and C)**

- Never use any part of your body to intentionally activate the jam protection function.
- The jam protection function may not work if something gets jammed just before the window is fully closed. Be careful not to get any part of your body jammed in the window.

■ **Catch protection function (windows with one-touch function for type B and C)**

- Never use any part of your body or clothing to intentionally activate the catch protection function.
- The catch protection function may not work if something gets caught just before the window is fully opened. Be careful not to get any part of your body or clothing caught in the window.

 **NOTICE**

■ **Jam protection function and catch protection function (windows with one-touch function for type B and C)**

If the door is forcefully closed while the window is being opened or closed, the jam protection function or catch protection function may operate and the window may reverse directions or stop.

Quarter windows (smart-cab models)

Opening and closing procedures

The quarter windows can be opened and closed using the latch handle.

To open the quarter windows, pull the latch handle toward you and swing it fully out.

To close the quarter windows, reverse the opening procedure.

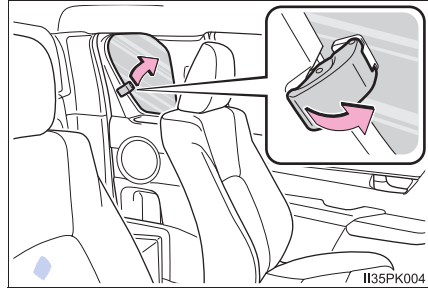

■ Closing the quarter windows

Make sure that the quarter windows are securely closed after closing them.

⚠ WARNING

■ Opening or closing the quarter windows

Observe the following precautions.
Failure to do so may result in death or serious injury.

- Check to make sure that all passengers do not have any part of their body in a position where it could be caught when a window is being operated.
- Do not allow children to operate the quarter windows.
Closing a quarter window on someone can cause serious injury, and in some instances, even death.

Back window (sliding type)

Opening and closing procedures

The back window can be opened and closed using the lock release lever.

To open the back window, push the lock release lever and slide the back window.

To close the back window, reverse the opening procedure.

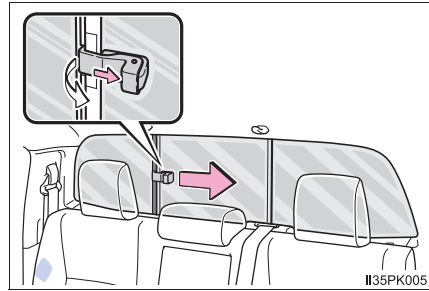

■ Closing the back window

Make sure that the back window is securely closed after closing it.

⚠ WARNING

■ Opening or closing the back window

Observe the following precautions.
Failure to do so may result in death or serious injury.

- Check to make sure that all passengers do not have any part of their body in a position where it could be caught when the window is being operated.
- Do not allow children to operate the back window.
Closing the back window on someone can cause serious injury, and in some instances, even death.

امداد خودرو فارما

تلفن شبانه روزی: ۰۲۱-۸۸۸۶۲۰۸۵

FarmaSOS.com

Driving

4

4-1. Before driving

Driving the vehicle	208
Cargo and luggage	221
Trailer towing (except models for model code destination W).....	222
Trailer towing (models for model code destination W).....	223

4-2. Driving procedures

Engine (ignition) switch (vehicles without smart entry & start system).....	236
Engine (ignition) switch (vehicles with smart entry & start system).....	239
Automatic transmission	247
Manual transmission.....	254
Turn signal lever	260
Parking brake	261

4-3. Operating the lights and wipers

Headlight switch	262
Fog light switch.....	269
Windshield wipers and washer	271

4-4. Refueling

Opening the fuel tank cap.....	274
--------------------------------	-----

4-5. Using the driving support systems

Toyota Safety Sense	279
PCS (Pre-Crash Safety system).....	287
LDA (Lane Departure Alert).....	300
RSA (Road Sign Assist).....	309
Cruise control.....	314
Rear view monitor system	318
Four-wheel drive system.....	329
Rear differential lock system.....	339
Stop & Start system (Smart Stop)	343
Driving assist systems	353
Downhill assist control system	361
DPF (Diesel Particulate Filter) system	364

4-6. Driving tips

Winter driving tips	368
---------------------------	-----

Driving the vehicle

The following procedures should be observed to ensure safe driving:

Starting the engine

→P. 236, 239

Driving

▶ Automatic transmission

- 1 With the brake pedal depressed, shift the shift lever to D. (→P. 247)
- 2 Release the parking brake. (→P. 261)
- 3 Gradually release the brake pedal and gently depress the accelerator pedal to accelerate the vehicle.

▶ Manual transmission

- 1 While depressing the clutch pedal, shift the shift lever to 1. (→P. 254)
- 2 Release the parking brake. (→P. 261)
- 3 Gradually release the clutch pedal. At the same time, gently depress the accelerator pedal to accelerate the vehicle.

FarmaSOS.com

Stopping

▶ Automatic transmission

- 1 With the shift lever in D, depress the brake pedal.
- 2 If necessary, set the parking brake.

If the vehicle is to be stopped for an extended period of time, shift the shift lever to P or N. (→P. 247)

▶ Manual transmission

- 1 While depressing the clutch pedal, depress the brake pedal.
- 2 If necessary, set the parking brake.

If the vehicle is to be stopped for an extended period of time, shift the shift lever to N. (→P. 254)

Parking the vehicle

▶ Automatic transmission

- 1 With the shift lever in D, depress the brake pedal.
- 2 Set the parking brake (→P. 261), and shift the shift lever to P (→P. 247).
- 3 Vehicles without smart entry & start system:
Turn the engine switch to the "LOCK" position to stop the engine.
Vehicles with smart entry & start system:
Press the engine switch to stop the engine.
- 4 Lock the door, making sure that you have the key on your person.
If parking on a hill, block the wheels as needed.

► Manual transmission

- 1 While depressing the clutch pedal, depress the brake pedal.
- 2 Shift the shift lever to N. (→P. 254)
If parking on a hill, shift the shift lever to 1 or R as needed.
- 3 Set the parking brake. (→P. 261)
- 4 Vehicles without smart entry & start system:
Turn the engine switch to the “LOCK” position to stop the engine.
Vehicles with smart entry & start system:
Press the engine switch to stop the engine.
- 5 Lock the door, making sure that you have the key on your person.
If parking on a hill, block the wheels as needed.

Starting off on a steep uphill

► Automatic transmission

- 1 Make sure that the parking brake is set and shift the shift lever to D.
- 2 Gently depress the accelerator pedal.
- 3 Release the parking brake.

► Manual transmission

- 1 With the parking brake firmly set and the clutch pedal fully depressed, shift the shift lever to 1.
- 2 Lightly depress the accelerator pedal at the same time as gradually releasing the clutch pedal.
- 3 Release the parking brake.

■ When starting off on an uphill (vehicles with hill-start assist control system)

The hill-start assist control will activate. (→P. 353)

■ Driving in the rain

- Drive carefully when it is raining, because visibility will be reduced, the windows may become fogged-up, and the road will be slippery.
- Drive carefully when it starts to rain, because the road surface will be especially slippery.
- Refrain from high speeds when driving on an expressway in the rain, because there may be a layer of water between the tires and the road surface, preventing the steering and brakes from operating properly.

■ Engine speed while driving (automatic transmission)

In the following conditions, the engine speed may become high while driving. This is due to automatic up-shifting control or down-shifting implementation to meet driving conditions. It does not indicate sudden acceleration.

- The vehicle is judged to be driving uphill or downhill
- When the accelerator pedal is released

■ Restraining the engine output (Brake Override System)

- When the accelerator and brake pedals are depressed at the same time, the engine output may be restrained.
- Vehicles without multi-information display: A warning light comes on while the system is operating. (→P. 570)
- Vehicles with multi-information display: A warning message is displayed on the multi-information display while the system is operating.

■ Breaking in your new Toyota

To extend the life of the vehicle, observing the following precautions is recommended:

- For the first 300 km (200 miles):
Avoid sudden stops.
- For the first 800 km (500 miles) (models for model code destination W*):
Do not tow a trailer. (→P. 223)

*: See “Checking your vehicle’s model” if you are not sure of which model your vehicle is. (→P. 11)

- For the first 1000 km (600 miles):
 - Do not drive at extremely high speeds.
 - Avoid sudden acceleration.
 - Do not drive continuously in the low gears.
 - Do not drive at a constant speed for extended periods.
 - Do not drive slowly with the manual transmission in a high gear.

■ Idling time before stopping the engine (diesel engine only)

To prevent damage to the turbocharger, allow the engine to idle immediately after high-speed driving or driving up a hill.

Driving condition		Idling time
Normal city driving		Not necessary
High-speed driving	Constant speed of approx. 80 km/h (50 mph)	Approximately 20 seconds
	Constant speed of approx. 100 km/h (62 mph)	Approximately 1 minute
Steep hill driving or continuous driving at 100 km/h (62 mph) or more (race track driving etc.)		Approximately 2 minutes

■ Operating your vehicle in a foreign country

Comply with the relevant vehicle registration laws and confirm the availability of the correct fuel. (→P. 627)

■ Eco-friendly driving

→P. 126

■ After driving on muddy roads in poor condition (for EURO VI models*)

Check the cooling fins of the urea injector and clear away any foreign objects or substances such as leaves or mud. If any of the above parts is extremely dirty or you are not sure of their condition, have your vehicle inspected by any authorized Toyota dealer or repairer, or another duly qualified and equipped professional.

*: EURO VI is an emission standard. If it is not clear that your vehicle meets relevant standards, contact any authorized Toyota dealer or repairer, or another duly qualified and equipped professional.

 **WARNING**

Observe the following precautions.
Failure to do so may result in death or serious injury.

■ When starting the vehicle

On vehicles with automatic transmission, always keep your foot on the brake pedal while stopped with the engine running. This prevents the vehicle from creeping.

■ When driving the vehicle

- Do not drive if you are unfamiliar with the location of the brake and accelerator pedals to avoid depressing the wrong pedal.
 - Accidentally depressing the accelerator pedal instead of the brake pedal will result in sudden acceleration that may lead to an accident.
 - When backing up, you may twist your body around, leading to a difficulty in operating the pedals. Make sure to operate the pedals properly.
 - Make sure to keep a correct driving posture even when moving the vehicle only slightly. This allows you to depress the brake and accelerator pedals properly.
 - Depress the brake pedal using your right foot. Depressing the brake pedal using your left foot may delay response in an emergency, resulting in an accident.
- Do not drive the vehicle over or stop the vehicle near flammable materials. The exhaust system and exhaust gases can be extremely hot. These hot parts may cause a fire if there is any flammable material nearby.

**WARNING**

Observe the following precautions.

Failure to do so may result in death or serious injury.

■ When driving the vehicle

- During normal driving, do not turn off the engine. Turning the engine off while driving will not cause loss of steering or braking control, but the power assist to these systems will be lost. This will make it more difficult to steer and brake, so you should pull over and stop the vehicle as soon as it is safe to do so.

However, in the event of an emergency, such as if it becomes impossible to stop the vehicle in the normal way: →P. 557

- Use engine braking (downshift) to maintain a safe speed when driving down a steep hill.
Using the brakes continuously may cause the brakes to overheat and lose effectiveness. (→P. 248)
- Do not adjust the positions of the steering wheel, the seat, or the inside or outside rear view mirrors while driving.
Doing so may result in a loss of vehicle control.
- Always check that all passengers' arms, heads or other parts of their body are not outside the vehicle.
- On vehicles with manual transmission, do not operate the clutch halfway for a long period of time unless it is necessary. Doing so could not only speed up clutch wear, but could also damage the clutch or even cause a fatal accident such as vehicle fire.

■ When driving on slippery road surfaces

- Sudden braking, acceleration and steering may cause tire slippage and reduce your ability to control the vehicle.
- Sudden acceleration, engine braking due to shifting, or changes in engine speed could cause the vehicle to skid.
- After driving through a puddle, lightly depress the brake pedal to make sure that the brakes are functioning properly. Wet brake pads may prevent the brakes from functioning properly. If the brakes on only one side are wet and not functioning properly, steering control may be affected.

 **WARNING**

Observe the following precautions.
Failure to do so may result in death or serious injury.

■ **When shifting the shift lever**

- On vehicles with automatic transmission, do not let the vehicle roll backwards while the shift lever is in a driving position, or roll forward while the shift lever is in R.
Doing so may cause the engine to stall or lead to poor brake and steering performance, resulting in an accident or damage to the vehicle.
- On vehicles with automatic transmission, do not shift the shift lever to P while the vehicle is moving.
Doing so can damage the transmission and may result in a loss of vehicle control.
- Do not shift the shift lever to R while the vehicle is moving forward.
Doing so can damage the transmission and may result in a loss of vehicle control.
- Do not shift the shift lever to a driving position while the vehicle is moving backward.
Doing so can damage to the transmission and may result in a loss of vehicle control.
- Moving the shift lever to N while the vehicle is moving will disengage the engine from the transmission. Engine braking is not available when N is selected.
- On vehicles with automatic transmission, be careful not to shift the shift lever with the accelerator pedal depressed. Shifting the shift lever to a gear other than P or N may lead to unexpected rapid acceleration of the vehicle that may cause an accident.

■ **If you hear a squealing or scraping noise (brake pad wear indicators)**

Have the brake pads checked and replaced by any authorized Toyota dealer or repairer, or another duly qualified and equipped professional as soon as possible.

Rotor damage may result if the pads are not replaced when needed.

It is dangerous to drive the vehicle when the wear limits of the brake pads and/or those of the brake discs are exceeded.

WARNING

Observe the following precautions.
Failure to do so may result in death or serious injury.

■ When the vehicle is stopped

- Do not race the engine.
If the vehicle is in any gear other than P (vehicles with automatic transmission only) or N, the vehicle may accelerate suddenly and unexpectedly, causing an accident.
- On vehicles with automatic transmission, in order to prevent accidents due to the vehicle rolling away, always keep depressing the brake pedal while the engine is running, and apply the parking brake as necessary.
- If the vehicle is stopped on an incline, in order to prevent accidents caused by the vehicle rolling forward or backward, always depress the brake pedal and securely apply the parking brake as needed.
- Avoid revving or racing the engine.
Running the engine at high speed while the vehicle is stopped may cause the exhaust system to overheat, which could result in a fire if combustible material is nearby.

■ When the vehicle is parked

- Do not leave glasses, cigarette lighters, spray cans, or soft drink cans in the vehicle when it is in the sun.
Doing so may result in the following:
 - Gas may leak from a cigarette lighter or spray can, and may lead to a fire.
 - The temperature inside the vehicle may cause the plastic lenses and plastic material of glasses to deform or crack.
 - Soft drink cans may fracture, causing the contents to spray over the interior of the vehicle, and may also cause a short circuit in the vehicle's electrical components.
- Do not leave cigarette lighters in the vehicle. If a cigarette lighter is in a place such as the glove box or on the floor, it may be lit accidentally when luggage is loaded or the seat is adjusted, causing a fire.
- Do not attach adhesive discs to the windshield or windows. Do not place containers such as air fresheners on the instrument panel or dashboard. Adhesive discs or containers may act as lenses, causing a fire in the vehicle.
- Do not leave a door or window open if the curved glass is coated with a metallized film such as a silver-colored one. Reflected sunlight may cause the glass to act as a lens, causing a fire.

 **WARNING**

Observe the following precautions.
Failure to do so may result in death or serious injury.

■ **When the vehicle is parked**

- Always apply the parking brake, shift the shift lever to P (vehicles with automatic transmission only), stop the engine and lock the vehicle. Do not leave the vehicle unattended while the engine is running. If the vehicle is parked with the shift lever in P but the parking brake is not set, the vehicle may start to move, possibly leading to an accident.
- Do not touch the exhaust pipes while the engine is running or immediately after turning the engine off. Doing so may cause burns.

■ **When taking a nap in the vehicle**

Always turn the engine off. Otherwise, if you accidentally move the shift lever or depress the accelerator pedal, this could cause an accident or fire due to engine overheating. Additionally, if the vehicle is parked in a poorly ventilated area, exhaust gases may collect and enter the vehicle, leading to death or a serious health hazard.

■ **When braking**

- When the brakes are wet, drive more cautiously. Braking distance increases when the brakes are wet, and this may cause one side of the vehicle to brake differently than the other side. Also, the parking brake may not securely hold the vehicle. تلفن شبانه
- If the power brake assist function does not operate, do not follow other vehicles closely and avoid hills or sharp turns that require braking. In this case, braking is still possible, but the brake pedal should be depressed more firmly than usual. Also, the braking distance will increase. Have your brakes fixed immediately.
- Do not pump the brake pedal if the engine stalls. Each push on the brake pedal uses up the reserve for the power-assisted brakes.
- The brake system consists of 2 individual hydraulic systems: If one of the systems fails, the other will still operate. In this case, the brake pedal should be depressed more firmly than usual and the braking distance will increase. Have your brakes fixed immediately.

■ **If the vehicle becomes stuck (4WD models)**

Do not spin the wheels excessively when any of the tires is up in the air, or the vehicle is stuck in sand, mud, etc. This may damage the driveline components or propel the vehicle forward or backward, causing an accident.



NOTICE

■ **When driving the vehicle**

- Do not depress the accelerator and brake pedals at the same time during driving, as this may restrain the engine output.
- On vehicles with automatic transmission, do not use the accelerator pedal or depress the accelerator and brake pedals at the same time to hold the vehicle on a hill.
- On vehicles with manual transmission, do not shift gears unless the clutch pedal is fully depressed. After shifting, do not release the clutch pedal abruptly. Doing so may damage the clutch, transmission and gears.
- On vehicles with manual transmission, observe the following to prevent the clutch from being damaged.
 - Do not rest your foot on the clutch pedal while driving. Doing so may cause clutch trouble.
 - Do not use any gear other than the 1st gear when starting off and moving forward. Doing so may damage the clutch.
 - Do not use the clutch to hold the vehicle when stopping on an uphill grade. Doing so may damage the clutch.
- On vehicles with manual transmission, do not shift the shift lever to R when the vehicle is still moving. Doing so may damage the clutch, transmission and gears.
- On vehicles with manual transmission, if you cannot accelerate the vehicle even when the clutch is engaged and the accelerator pedal is depressed, this may mean that the clutch is slipping, and the vehicle may be rendered undriveable. Have any authorized Toyota dealer or repairer, or another duly qualified and equipped professional inspect the vehicle as soon as possible.

 NOTICE

■ **When parking the vehicle**

On vehicles with automatic transmission, always set the parking brake, and shift the shift lever to P. Failure to do so may cause the vehicle to move or the vehicle may accelerate suddenly if the accelerator pedal is accidentally depressed.

■ **Avoiding damage to vehicle parts**

- Do not turn the steering wheel fully in either direction and hold it there for an extended period of time.
Doing so may damage the power steering pump.
- When driving over bumps in the road, drive as slowly as possible to avoid damaging the wheels, underside of the vehicle, etc.
- Diesel engine: Make sure to idle the engine immediately after high-speed driving or hill climbing. Stop the engine only after the turbocharger has cooled down.
Failure to do so may cause damage to the turbocharger.

■ **If you get a flat tire while driving**

A flat or damaged tire may cause the following situations. Hold the steering wheel firmly and gradually depress the brake pedal to slow down the vehicle.

- It may be difficult to control your vehicle.
- The vehicle will make abnormal sounds or vibrations.
- The vehicle will lean abnormally.

Information on what to do in case of a flat tire. (→P. 584)



NOTICE

■ When encountering flooded roads

Do not drive on a road that has flooded after heavy rain etc. Doing so may cause the following serious damage to the vehicle:

- Engine stalling
- Short in electrical components
- Engine damage caused by water immersion

In the event that you drive on a flooded road and the vehicle is flooded, be sure to have any authorized Toyota dealer or repairer, or another duly qualified and equipped professional check the following:

- Brake function
- Changes in quantity and quality of oil and fluid used for the engine, transmission, transfer (4WD models), differential, etc.
- Lubricant condition for the propeller shaft, bearings and suspension joints (where possible), and the function of all joints, bearings, etc.

■ Off-road driving (vehicles with type A wheel ornaments [→P. 591])

When driving on muddy roads, rocky terrain or sand, or crossing rivers, remove the wheel ornaments. Driving with the wheel ornaments installed may cause the wheel ornaments to be damaged or even fall off.

After off-road driving with the wheel ornaments removed, remove dirt or foreign objects from the wheel before reinstalling the wheel ornaments.

تلفن شبانه روزی: ۰۲۱-۸۸۸۶۲۰۸۵

FarmaSOS.com

Cargo and luggage

Take notice of the following information about storage precautions, cargo capacity and load.

WARNING

■ Things that must not be carried in the rear deck

The following things may cause a fire if loaded in the rear deck:

- Receptacles containing gasoline
- Aerosol cans

■ Storage precautions

Observe the following precautions.

Failure to do so may prevent the pedals from being depressed properly, may block the driver's vision, or may result in items hitting the driver or passengers, possibly causing an accident.

- Stow cargo and luggage in the rear deck whenever possible.
 - Except for single-cab models: Do not stack anything behind the front seats higher than the seatbacks.
 - Do not place cargo or luggage in or on the following locations.
 - At the feet of the driver
 - On the front passenger or rear seats (if equipped) (when stacking items)
 - On the instrument panel
 - On the dashboard
 - Secure all items in the occupant compartment.
 - Never allow anyone to ride in the rear deck. It is not designed for passengers. They should ride in their seats with their seat belts properly fastened. Otherwise, they are much more likely to suffer death or serious bodily injury, in the event of sudden braking, sudden swerving or an accident.
- #### ■ Load and distribution
- Do not overload your vehicle.
 - Do not apply loads unevenly. Improper loading may cause deterioration of steering or braking control which may cause death or serious injury.

Trailer towing (except models for model code destination W*)

Toyota does not recommend towing a trailer with your vehicle. Toyota also does not recommend the installation of a tow hitch or the use of a tow hitch carrier for a wheelchair, scooter, bicycle, etc. Your vehicle is not designed for trailer towing or for the use of tow hitch mounted carriers.

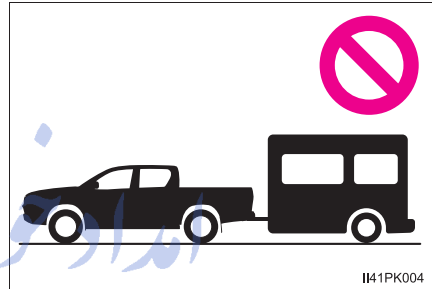

تلفن شبانه روزی: ۰۲۱-۸۸۸۶۲۰۸۵

FarmaSOS.com

*: See "Checking your vehicle's model" if you are not sure of which model your vehicle is.
(→P. 11)

Trailer towing (models for model code destination W*)

Your vehicle is designed primarily as a passenger-and-load-carrying vehicle. Towing a trailer will have an adverse effect on handling, performance, braking, durability, and fuel consumption. Your safety and satisfaction depend on the proper use of correct equipment and cautious driving habits. For your safety and the safety of others, do not overload the vehicle or trailer.

To tow a trailer safely, use extreme care and drive the vehicle in accordance with the trailer's characteristics and operating conditions.

Toyota warranties do not apply to damage or malfunction caused by towing a trailer for commercial purposes.

Ask your local authorized Toyota dealer or repairer, or another duly qualified and equipped professional for further details before towing, as there are additional legal requirements in some countries.

◆ Weight limits

Check the allowable towing capacity, GVM (Gross Vehicle Mass), MPAC (Maximum Permissible Axle Capacity), and permissible drawbar load before towing. (→P. 621)

◆ Towing hitch/bracket

Toyota recommends the use of the Toyota hitch/bracket for your vehicle. Other products of a suitable nature and comparable quality may also be used.

*: See "Checking your vehicle's model" if you are not sure of which model your vehicle is. (→P. 11)

Installation positions for the towing hitch/bracket and hitch ball

- ① 570 mm (22.4 in.)
- ② 570 mm (22.4 in.)

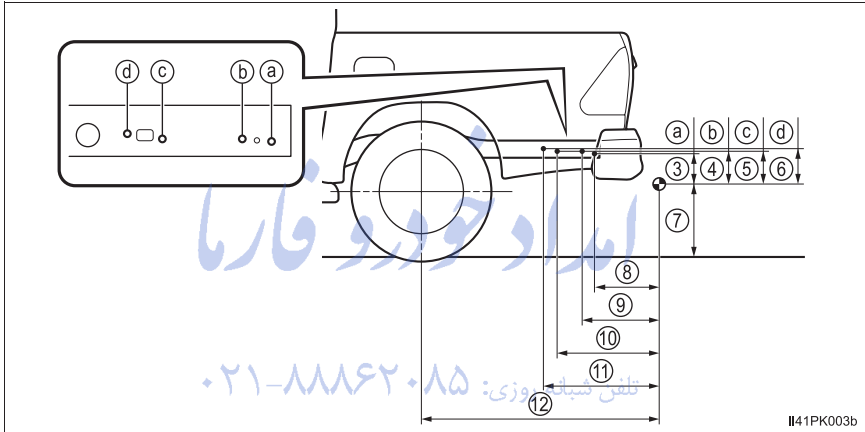
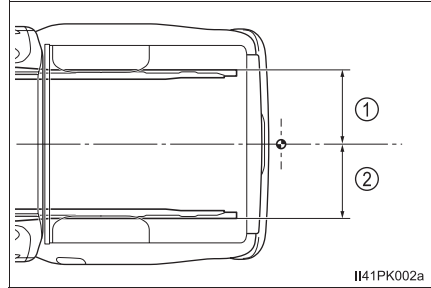

- ③ 178 mm (7.0 in.)
- ④ 183 mm (7.2 in.)
- ⑤ 183 mm (7.2 in.)
- ⑥ 193 mm (7.6 in.)
- ⑦ 225/70R17C tires:
382 mm (15.0 in.)
- 265/65R17 or 265/60R18 tires:
381 mm (15.0 in.)
- ⑧ 373 mm (14.7 in.)
- ⑨ 427 mm (16.8 in.)
- ⑩ 576 mm (22.7 in.)
- ⑪ 641 mm (25.2 in.)
- ⑫ 1343 mm (52.9 in.)

Guidance

Your vehicle will handle differently when towing a trailer. In order to avoid accident death or serious injury, keep the following in mind when towing:

■ Checking connections between trailer and lights

Stop the vehicle and check the operation of the connection between the trailer and lights after driving for a brief period as well as before starting off.

■ Practicing driving with a coupled trailer

- Get the feel for turning, stopping and reversing with the trailer coupled by practicing in an area with no or light traffic.
- When reversing with a coupled trailer, hold the section of the steering wheel nearest to you and rotate clockwise to turn the trailer left or counterclockwise to turn it right. Always rotate a little at a time to prevent steering error. Have someone guide you when reversing to lessen the risk of accident.

■ Increasing vehicle-to-vehicle distance

At a speed of 10 km/h (6 mph), the distance to the vehicle running ahead of you should be equivalent to or greater than the combined length of your vehicle and trailer. Avoid sudden braking that may cause skidding. Otherwise, the vehicle may spin out of control. This is especially true when driving on wet or slippery road surfaces.

■ Sudden acceleration/steering input/cornering

Executing sharp turns when towing may result in the trailer colliding with your vehicle. Decelerate well in advance when approaching turns and take them slowly and carefully to avoid sudden braking.

■ Important points regarding turning

The wheels of the trailer will travel closer to the inside of the curve than the wheels of the vehicle. To make allowance for this, take the turns wider than you would normally do.

■ Important points regarding stability

Vehicle movement resulting from uneven road surfaces and strong crosswinds will affect handling. The vehicle may also be rocked by passing buses or large trucks. Frequently check behind when moving alongside such vehicles. As soon as such vehicle movement occurs, immediately start to decelerate smoothly by slowly applying the brakes. Always steer the vehicle straight ahead while braking.

■ Passing other vehicles

Consider the total combined length of your vehicle and trailer and ensure that the vehicle-to-vehicle distance is sufficient before executing lane changes.

■ Transmission information

Vehicles with manual transmission: To maintain engine braking efficiency when using engine braking, do not use 5th gear and 6th gear.

Vehicles with automatic transmission: To maintain engine braking efficiency when using engine braking, do not use the transmission in D. Transmission shift range position must be in 4 or lower, in S mode.

■ If the engine overheats

Towing a loaded trailer up a long, steep incline in temperatures exceeding 30°C (85°F) may result in the engine overheating. If the engine coolant temperature gauge indicates that the engine is overheating, turn the air conditioning off immediately, leave the road and stop the vehicle in a safe place. (→P. 613)

■ When parking the vehicle

Always place wheel chocks under the wheels of both the vehicle and trailer. Firmly set the parking brake and shift the shift lever to P for automatic transmissions, and 1 or R for manual transmissions.

 **WARNING**

Follow all the instructions described in this section. Failure to do so could cause an accident resulting in death or serious injury.

■ **Trailer towing precautions**

When towing, make sure that none of the weight limits are exceeded.
(→P. 228)

■ **Vehicle speed in towing**

Observe the legal maximum speeds for trailer towing.

■ **Before descending hills or long declines**

Reduce speed and downshift. However, never downshift suddenly while descending steep or long down hill grades.

■ **Operation of the brake pedal**

Do not hold the brake pedal depressed often or for long periods of time. Doing so may result in the brake overheating or reduce braking effects.

■ **To avoid accident or injury**

● The gross combination mass (sum of your vehicle mass plus its load and the total trailer mass) must not exceed the following:

▶ Single-cab models

5530 kg (12191 lb.): Pre Runner

5850 kg (12897 lb.): 4WD models

▶ Smart-cab models

5850 kg (12897 lb.)

▶ Double-cab models

5850 kg (12897 lb.): Except Pre Runner for EURO V* models for Turkey

*: EURO V is an emission standard. If it is not clear that your vehicle meets relevant standards, contact any authorized Toyota dealer or repairer, or another duly qualified and equipped professional.

● Do not use cruise control (if equipped) when trailer towing.

Important points regarding trailer loads (except for single-cab 4WD models, smart-cab 4WD models without rear seat cushion and GUN125L-CNFHW3 model*)

■ Total trailer weight and permissible drawbar load

① Total trailer weight

Weight of the trailer itself plus the trailer load should be within the maximum towing capacity. Exceeding this weight is dangerous. (→P. 621)

When towing a trailer, use a friction coupler or friction stabilizer (sway control device).

When the total trailer weight is over 2000 kg (4409 lb.), a friction stabilizer (sway control device) is required.

② Permissible drawbar load

Allocate the trailer load so that the drawbar load is greater than 25 kg (55.1 lb.) or 4% of the towing capacity. Do not let the drawbar load exceed the indicated weight. (→P. 621)

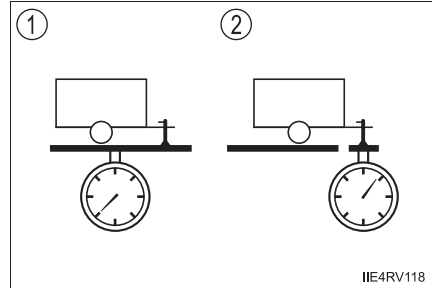

تلفن شبانه روزی: ۰۲۱-۸۸۸۶۲۰۸۵

FarmaSOS.com

*: The model code is indicated on the manufacturer's plate or label. (→P. 623)

■ Information tag (manufacturer's label)

① Gross vehicle mass

The combined weight of the driver, passengers, cargo, towing hitch, total curb mass and drawbar load must not exceed the gross vehicle mass. Exceeding this weight is dangerous.

② Maximum permissible rear axle capacity

The weight borne by the rear axle should not exceed the maximum permissible rear axle capacity. Exceeding this weight is dangerous.

The values for towing capacity were derived from testing conducted at sea level. Take note that engine output and towing capacity will be reduced at high altitudes.

► Type A

► Type B

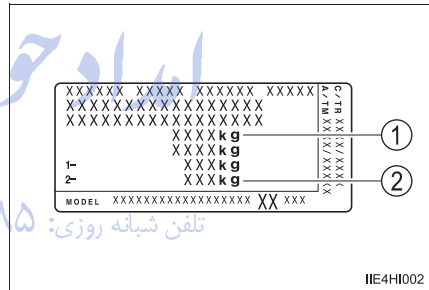
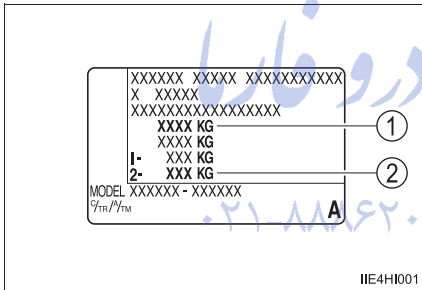

■ Tire information

- Increase the tire inflation pressure to 20.0 kPa (0.2 kgf/cm² or bar, 3 psi) greater than the recommended value when towing. (→P. 642)
- Increase the air pressure of the trailer tires in accordance with the total trailer weight and according to the values recommended by the manufacturer of your trailer.

■ Trailer lights

Check that the turn signal lights and stoplights are operating correctly every time you hitch up the trailer. Directly wiring up to your vehicle may damage the electrical system and stop the lights from functioning correctly.

■ Break-in schedule

Toyota recommends that vehicles fitted with new power train components should not be used for towing trailers for the first 800 km (500 miles).

■ Safety checks before towing

- Check that the maximum load limit for the towing hitch/bracket and hitch ball is not exceeded. Bear in mind that the coupling weight of the trailer will add to the load exerted on the vehicle. Also make sure that the total load exerted on the vehicle is within the range of the weight limits. (→P. 228)
- Ensure that the trailer load is secure.
- Supplementary outside rear view mirrors should be added to the vehicle if the traffic behind cannot be clearly seen with standard mirrors. Adjust the extending arms of these mirrors on both sides of the vehicle so that they always provide maximum visibility of the road behind.

■ Maintenance

- Maintenance must be performed more frequently when using the vehicle for towing due to the greater weight burden placed on the vehicle compared to normal driving.
- Retighten all bolts securing the hitching ball and bracket after towing for approximately 1000 km (600 miles).

■ If trailer sway occurs

One or more factors (crosswinds, passing vehicles, rough roads, etc.) can adversely affect handling of your vehicle and trailer, causing instability.

● If trailer swaying occurs:

- Firmly grip the steering wheel. Steer straight ahead.
Do not try to control trailer swaying by turning the steering wheel.
- Begin releasing the accelerator pedal immediately but very gradually to reduce speed.

Do not increase speed. Do not apply vehicle brakes.

If you make no extreme correction with the steering or brakes, your vehicle and trailer should stabilize (if enabled, Trailer Sway Control can also help to stabilize the vehicle and trailer.).

● After the trailer swaying has stopped:

- Stop in a safe place. Get all occupants out of the vehicle.
- Check the tires of the vehicle and the trailer.
- Check the load in the trailer.
Make sure the load has not shifted.
Make sure the tongue weight is appropriate, if possible.
- Check the load in the vehicle.
Make sure the vehicle is not overloaded after occupants get in.

If you cannot find any problems, the speed at which trailer swaying occurred is beyond the limit of your particular vehicle-trailer combination.

Drive at a lower speed to prevent instability. Remember that swaying of the towing vehicle-trailer increases as speed increases.



NOTICE

■ When the rear bumper strengthening material is aluminum

Ensure the steel bracket part does not come directly in contact with that area.

When steel and aluminum come into contact, there is a reaction similar to corrosion, which will weaken the section concerned and may result in damage. Apply a rust inhibitor to parts that will come in contact when attaching a steel bracket.

Important points regarding trailer loads (for single-cab 4WD models, smart-cab 4WD models without rear seat cushion and GUN125L-CNFSHW3 model*)

■ **Total trailer weight and permissible drawbar load**

① Total trailer weight

Weight of the trailer itself plus the trailer load should be within the maximum towing capacity. Exceeding this weight is dangerous. (→P. 621)

When towing a trailer, use a friction coupler or friction stabilizer (sway control device).

When the total trailer weight is over 2000 kg (4409 lb.), a friction stabilizer (sway control device) is required.

② Permissible drawbar load

Allocate the trailer load so that the drawbar load is greater than 25 kg (55.1 lb.) or 4% of the towing capacity. Do not let the drawbar load exceed the indicated weight. (→P. 621)

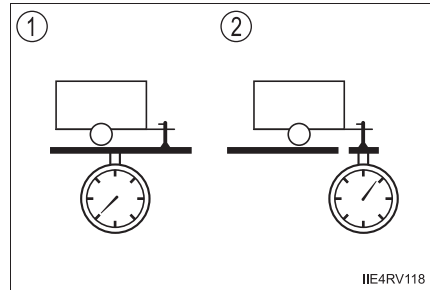

تلفن شبانه روزی: ۰۲۱-۸۸۸۶۲۰۸۵

FarmaSOS.com

*: The model code is indicated on the manufacturer's plate or label. (→P. 623)

■ Information tag (manufacturer's label)

① Gross vehicle mass

The combined weight of the driver, passengers, cargo, towing hitch, total curb mass and drawbar load must not exceed the gross vehicle mass. Exceeding this weight is dangerous.

② Maximum permissible rear axle capacity

The weight borne by the rear axle should not exceed the maximum permissible rear axle capacity. Exceeding this weight is dangerous.

The values for towing capacity were derived from testing conducted at sea level. Take note that engine output and towing capacity will be reduced at high altitudes.

▶ Type A

▶ Type B

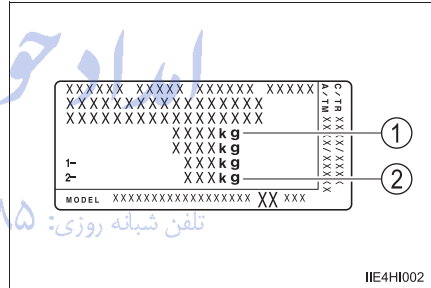
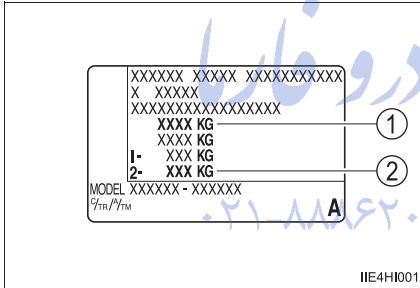

⚠ WARNING FarmaSOS.com

■ **When the total trailer weight exceeds 3200kg (7055 lb.)**
 Do not exceed the legal speed limit for towing a trailer or 90 km/h (56 mph), whichever is lower.
 Failing to observe this precaution may lead to an accident causing death or serious injury.

■ Tire information

- Increase the tire inflation pressure to 20.0 kPa (0.2 kgf/cm² or bar, 3 psi) greater than the recommended value when towing. (→P. 642)
- Increase the air pressure of the trailer tires in accordance with the total trailer weight and according to the values recommended by the manufacturer of your trailer.

■ Trailer lights

Check that the turn signal lights and stoplights are operating correctly every time you hitch up the trailer. Directly wiring up to your vehicle may damage the electrical system and stop the lights from functioning correctly.

■ Break-in schedule

Toyota recommends that vehicles fitted with new power train components should not be used for towing trailers for the first 800 km (500 miles).

■ Safety checks before towing

- Check that the maximum load limit for the towing hitch/bracket and hitch ball is not exceeded. Bear in mind that the coupling weight of the trailer will add to the load exerted on the vehicle. Also make sure that the total load exerted on the vehicle is within the range of the weight limits. (→P. 232)
- Ensure that the trailer load is secure.
- Supplementary outside rear view mirrors should be added to the vehicle if the traffic behind cannot be clearly seen with standard mirrors. Adjust the extending arms of these mirrors on both sides of the vehicle so that they always provide maximum visibility of the road behind.

■ Maintenance

- Maintenance must be performed more frequently when using the vehicle for towing due to the greater weight burden placed on the vehicle compared to normal driving.
- Retighten all bolts securing the hitching ball and bracket after towing for approximately 1000 km (600 miles).

■ If trailer sway occurs

One or more factors (crosswinds, passing vehicles, rough roads, etc.) can adversely affect handling of your vehicle and trailer, causing instability.

● If trailer swaying occurs:

- Firmly grip the steering wheel. Steer straight ahead.
Do not try to control trailer swaying by turning the steering wheel.
- Begin releasing the accelerator pedal immediately but very gradually to reduce speed.

Do not increase speed. Do not apply vehicle brakes.

If you make no extreme correction with the steering or brakes, your vehicle and trailer should stabilize (if enabled, Trailer Sway Control can also help to stabilize the vehicle and trailer.).

● After the trailer swaying has stopped:

- Stop in a safe place. Get all occupants out of the vehicle.
- Check the tires of the vehicle and the trailer.
- Check the load in the trailer.
Make sure the load has not shifted.
Make sure the tongue weight is appropriate, if possible.
- Check the load in the vehicle.

Make sure the vehicle is not overloaded after occupants get in.

If you cannot find any problems, the speed at which trailer swaying occurred is beyond the limit of your particular vehicle-trailer combination.

Drive at a lower speed to prevent instability. Remember that swaying of the towing vehicle-trailer increases as speed increases.



NOTICE

■ When the rear bumper strengthening material is aluminum

Ensure the steel bracket part does not come directly in contact with that area.

When steel and aluminum come into contact, there is a reaction similar to corrosion, which will weaken the section concerned and may result in damage. Apply a rust inhibitor to parts that will come in contact when attaching a steel bracket.

Engine (ignition) switch (vehicles without smart entry & start system)

Starting the engine

▶ Automatic transmission (gasoline engine)

- 1 Check that the parking brake is set.
- 2 Check that the shift lever is set in P.
- 3 Firmly depress the brake pedal.
- 4 Turn the engine switch to the “START” position to start the engine.

▶ Automatic transmission (diesel engine)

- 1 Check that the parking brake is set.
- 2 Check that the shift lever is set in P.
- 3 Firmly depress the brake pedal.
- 4 Turn the engine switch to the “ON” position.

The  indicator turns on.

- 5 After the  indicator light goes out, turn the engine switch to the “START” position to start the engine.

▶ Manual transmission (gasoline engine)

- 1 Check that the parking brake is set.
- 2 Check that the shift lever is set in N.
- 3 Firmly depress the clutch pedal.
- 4 Turn the engine switch to the “START” position to start the engine.

▶ Manual transmission (diesel engine)

- 1 Check that the parking brake is set.
- 2 Check that the shift lever is set in N.
- 3 Firmly depress the clutch pedal.
- 4 Turn the engine switch to the “ON” position.

The  indicator turns on.

- 5 After the  indicator light goes out, turn the engine switch to the “START” position to start the engine.

Changing the engine switch positions

① “LOCK”

The steering wheel is locked and the key can be removed. (Vehicles with automatic transmission: The key can be removed only when the shift lever is in P.)

② “ACC”

Some electrical components such as the audio system can be used.

③ “ON”

All electrical components can be used.

④ “START”

For starting the engine.

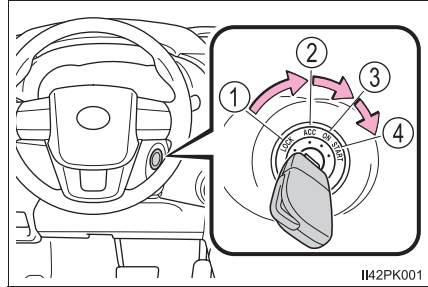

■ Turning the key from “ACC” to “LOCK”

- ① Shift the shift lever to P (automatic transmission) or N (manual transmission). (→P. 247, 254)
- ② Push in the key and turn it to the “LOCK” position.

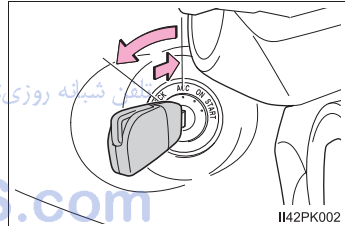

■ If the engine does not start (vehicles with engine immobilizer system)

The engine immobilizer system may not have been deactivated. (→P. 107)

Contact any authorized Toyota dealer or repairer, or another duly qualified and equipped professional.

■ When the steering lock cannot be released

When starting the engine, the engine switch may seem stuck in the “LOCK” position. To free it, turn the key while turning the steering wheel slightly left and right.

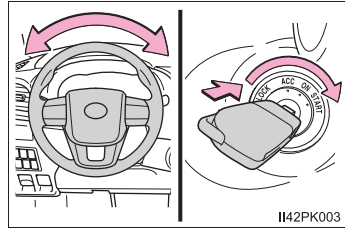

■ Key reminder function (if equipped)

A buzzer sounds if the driver's door is opened while the engine switch is in the “LOCK” or “ACC” position to remind you to remove the key.

⚠ WARNING

■ When starting the engine

Always start the engine while sitting in the driver's seat. Do not depress the accelerator pedal while starting the engine under any circumstances. Doing so may cause an accident resulting in death or serious injury.

■ Caution when driving

Do not turn the engine switch to the “LOCK” position while driving. If in an emergency, you must turn the engine off while the vehicle is moving, turn the engine switch only to the “ACC” position to stop the engine. An accident may result if the engine is stopped while driving. (→P. 557)

⚠ NOTICE

■ To prevent battery discharge

Do not leave the engine switch in the “ACC” or “ON” position for long periods of time without the engine running.

■ When starting the engine

- Do not crank the engine for more than 30 seconds at a time. This may overheat the starter and wiring system.
- Do not race a cold engine.
- If the engine becomes difficult to start or stalls frequently, have your vehicle checked by any authorized Toyota dealer or repairer, or another duly qualified and equipped professional immediately.

Engine (ignition) switch (vehicles with smart entry & start system)

Performing the following operations when carrying the electronic key on your person starts the engine or changes engine switch modes.

Starting the engine

► Automatic transmission

- 1 Check that the parking brake is set.
- 2 Check that the shift lever is set in P.
- 3 Firmly depress the brake pedal.

A message will be displayed on the multi-information display. If it is not displayed, the engine cannot be started.

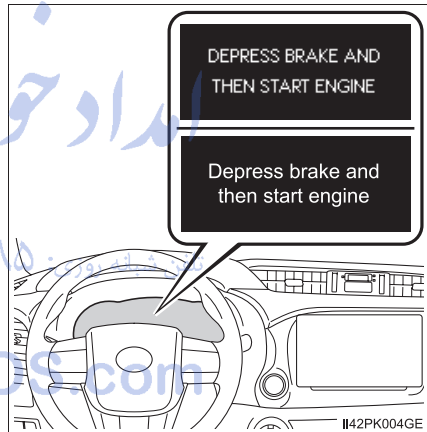

- 4 Press the engine switch shortly and firmly.

When operating the engine switch, one short, firm press is enough. It is not necessary to press and hold the switch.

The engine will crank until it starts or for up to 30 seconds, whichever is less.

Continue depressing the brake pedal until the engine is completely started.

Diesel engine only: the  indicator turns on. The engine will start after the indicator light goes out.

The engine can be started from any engine switch mode.

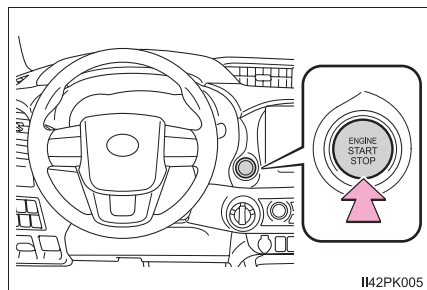

► Manual transmission

- 1 Check that the parking brake is set.
- 2 Check that the shift lever is set in N.
- 3 Firmly depress the clutch pedal.

A message will be displayed on the multi-information display. If it is not displayed, the engine cannot be started.

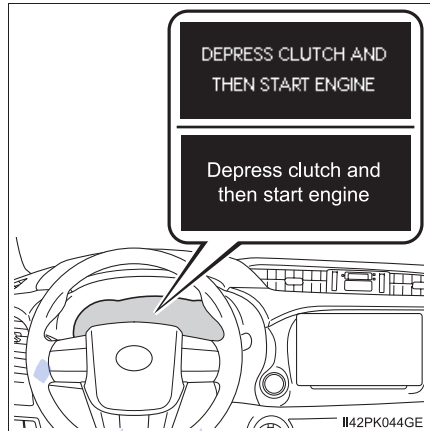

- 4 Press the engine switch shortly and firmly.

When operating the engine switch, one short, firm press is enough. It is not necessary to press and hold the switch.

The engine will crank until it starts or for up to 30 seconds, whichever is less.

Continue depressing the clutch pedal until the engine is completely started.

Diesel engine only: the  indicator turns on. The engine will start after the indicator light goes out.

The engine can be started from any engine switch mode.

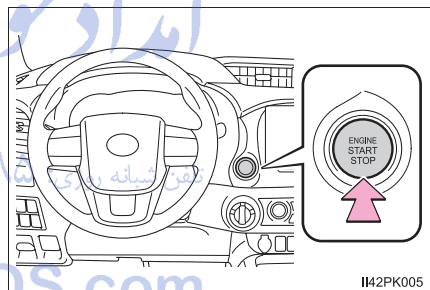

Stopping the engine

▶ Automatic transmission

- 1 Stop the vehicle.
- 2 Set the parking brake (→P. 261), and shift the shift lever to P.
- 3 Press the engine switch.
- 4 Release the brake pedal and check that the display on the instrument cluster is off.

▶ Manual transmission

- 1 Stop the vehicle.
- 2 Shift the shift lever to N.
- 3 Set the parking brake. (→P. 261)
- 4 Press the engine switch.
- 5 Release the brake pedal and check that the display on the instrument cluster is off.

امداد خودرو فارما

تلفن شبانه روزی: ۰۲۱-۸۸۸۶۲۰۸۵

FarmaSOS.com

Changing engine switch modes

Modes can be changed by pressing the engine switch with brake pedal (vehicles with automatic transmission) or clutch pedal (vehicles with manual transmission) released. (The mode changes each time the switch is pressed.)

① Off*

The emergency flashers can be used.

② ACCESSORY mode

Some electrical components such as the audio system can be used. "ACCESSORY" will be displayed on the multi-information display.

③ IGNITION ON mode

All electrical components can be used.

"IGNITION ON" will be displayed on the multi-information display.

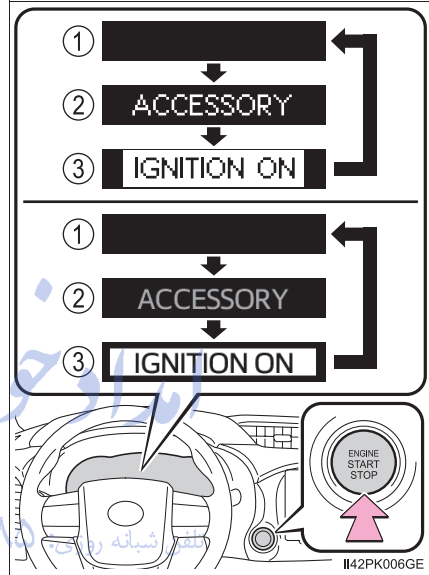

*: If the shift lever is in a position other than P when turning off the engine, the engine switch will be turned to ACCESSORY mode, not to off (vehicles with automatic transmission only).

When stopping the engine with the shift lever in a position other than P (vehicles with automatic transmission)

If the engine is stopped with the shift lever in a position other than P, the engine switch will not be turned off but instead be turned to ACCESSORY mode. Perform the following procedure to turn the switch off:

- 1 Check that the parking brake is set.
- 2 Shift the shift lever to P.
- 3 Check that "TURN OFF VEHICLE"/"Turn off vehicle" is displayed on the multi-information display and then press the engine switch once.

- 4 Check that “TURN OFF VEHICLE”/“Turn off vehicle” on the multi-information display is off.

■ **Note for the electronic key**

Carry the electronic key on your person, for example in your pocket.

The smart entry & start system does not operate properly if the electronic key is on the floor or the instrument panel, or in the door pockets, cup holders or auxiliary boxes.

■ **Auto power off function**

▶ Vehicles with automatic transmission

If the vehicle is left in ACCESSORY mode for more than 20 minutes or IGNITION ON mode (the engine is not running) for more than an hour with the shift lever in P, the engine switch will automatically turn off. However, this function cannot entirely prevent battery discharge. Do not leave the vehicle with the engine switch in ACCESSORY or IGNITION ON mode for long periods of time when the engine is not running.

▶ Vehicles with manual transmission

If the vehicle is left in ACCESSORY mode for more than 20 minutes or IGNITION ON mode (the engine is not running) for more than an hour, the engine switch will automatically turn off. However, this function cannot entirely prevent battery discharge. Do not leave the vehicle with the engine switch in ACCESSORY or IGNITION ON mode for long periods of time when the engine is not running.

■ **Operation of the engine switch**

If the switch is not pressed shortly and firmly, the engine switch mode may not change or the engine may not start.

■ **Electronic key battery depletion**

→P. 175

■ **Conditions affecting operation**

→P. 173

■ **Note for the entry function**

→P. 174

■ **If the engine does not start**

The engine immobilizer system may not have been deactivated. (→P. 107)

Contact any authorized Toyota dealer or repairer, or another duly qualified and equipped professional.

■ Steering lock

After turning the engine switch off and opening and closing the doors, the steering wheel will be locked due to the steering lock function. Operating the engine switch again automatically cancels the steering lock.

■ When the steering lock cannot be released

A message will be displayed on the multi-information display.

Check that the shift lever is set in P (except manual transmission). Press the engine switch while turning the steering wheel left and right.

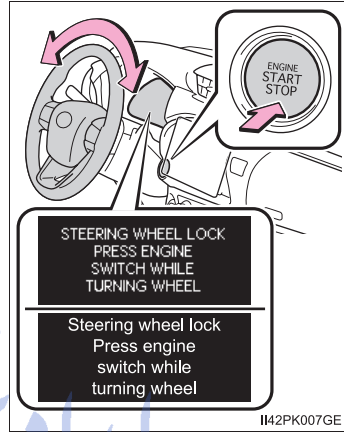

■ Steering lock motor overheating prevention

To prevent the steering lock motor from overheating, the motor may be suspended if the engine is turned on and off repeatedly in a short period of time. In this case, refrain from running the engine. After about 10 seconds, the steering lock motor will resume functioning. تلفن شبانه روزی.

■ If “SMART ENTRY & START SYSTEM MALFUNCTION SEE OWNER’S MANUAL”/“Smart Entry & Start System malfunction See owner’s manual” is shown on the multi-information display (if equipped)

The system may be malfunctioning. Have the vehicle inspected by any authorized Toyota dealer or repairer, or another duly qualified and equipped professional immediately.

■ If the electronic key battery is depleted

→P. 532

■ If the smart entry & start system has been deactivated in a customized setting

→P. 603

 **WARNING****■ When starting the engine**

Always start the engine while sitting in the driver's seat. Do not depress the accelerator pedal while starting the engine under any circumstances. Doing so may cause an accident resulting in death or serious injury.

■ Caution while driving

If engine failure occurs while the vehicle is moving, do not lock or open the doors until the vehicle reaches a safe and complete stop. Activation of the steering lock in this circumstance may lead to an accident, resulting in death or serious injury.

■ Stopping the engine in an emergency

- If you want to stop the engine in an emergency while driving the vehicle, press and hold the engine switch for more than 2 seconds, or press it briefly 3 times or more in succession. (→P. 557)
However, do not touch the engine switch while driving except in an emergency. If the engine switch is pressed while the vehicle is moving, the warning message "PUSH AND HOLD ENGINE SWITCH FOR EMERGENCY STOP"/"Push and hold engine switch for emergency stop" is displayed on the multi-information display and a buzzer sounds. Turning the engine off while driving will not cause loss of steering or braking control, but the power assist to these systems will be lost. This will make it more difficult to steer and brake, so you should pull over and stop the vehicle as soon as it is safe to do so.
- To restart the engine after turning off the engine while driving, shift the shift lever to N (automatic transmission) or depress the clutch pedal (manual transmission) and then press the engine switch.



NOTICE

■ To prevent battery discharge

- Do not leave the engine switch in ACCESSORY or IGNITION ON mode for long periods of time without the engine running.
- If “ACCESSORY” or “IGNITION ON” is displayed on the multi-information display while the engine is not running, the engine switch is not off. Exit the vehicle after turning the engine switch off.
- On vehicles with automatic transmission, do not stop the engine when the shift lever is in a position other than P. If the engine is stopped in another shift lever position, the engine switch will not be turned off but instead be turned to ACCESSORY mode. If the vehicle is left in ACCESSORY mode, battery discharge may occur.

■ When starting the engine

- Do not race a cold engine.
- If the engine becomes difficult to start or stalls frequently, have your vehicle checked by any authorized Toyota dealer or repairer, or another duly qualified and equipped professional immediately.

■ Symptoms indicating a malfunction with the engine switch

If the engine switch seems to be operating somewhat differently than usual, such as the switch sticking slightly, there may be a malfunction. Contact any authorized Toyota dealer or repairer, or another duly qualified and equipped professional immediately.

تلفن شبانه روزی: ۰۲۱-۸۸۶۲۰۸۵

Automatic transmission*

Select a shift position appropriate for the driving conditions.

Shifting the shift lever

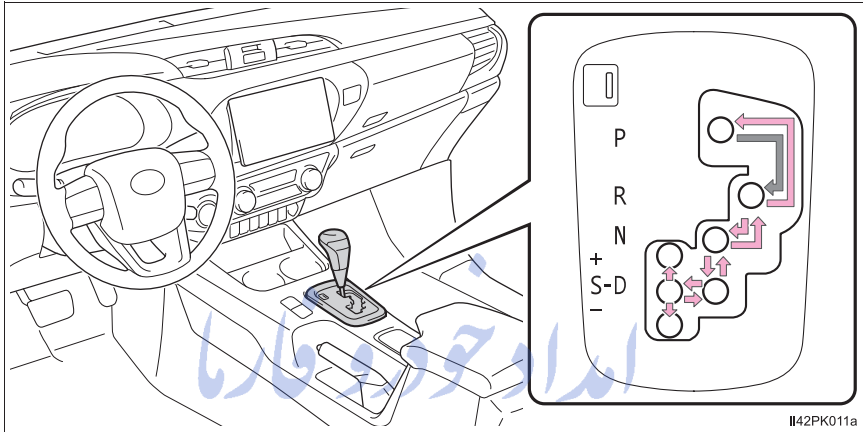

▶ Vehicles without smart entry & start system

- ← While the engine switch is in the “ON” position, move the shift lever with the brake pedal depressed.

When shifting the shift lever between P and D, make sure that the vehicle is completely stopped.

▶ Vehicles with smart entry & start system

- ← While the engine switch is in IGNITION ON mode, move the shift lever with the brake pedal depressed.

When shifting the shift lever between P and D, make sure that the vehicle is completely stopped.

*: If equipped

Shift position purpose

Shift position	Function
P	Parking the vehicle/starting the engine
R	Reversing
N	Neutral (Condition in which the power is not transmitted)
D	Normal driving ^{*1}
S	S mode driving ^{*2} (→P. 250)

*1: To improve fuel efficiency and reduce noises, set the shift lever in the D position for normal driving.

*2: Selecting shift ranges using S mode restricts the upper limit of the possible gear ranges, controls engine braking force, and prevents unnecessary upshifting.

امداد خودرو فارما

تلفن شبانه روزی: ۰۲۱-۸۸۸۶۲۰۸۵

FarmaSOS.com

Selecting the driving mode

The following modes can be selected to suit driving conditions.

■ Eco drive mode

Use Eco drive mode to help achieve low fuel consumption during trips that involve frequent accelerating.

Press the “ECO MODE” switch to select Eco drive mode.

The “ECO MODE” indicator light will come on.

Press the switch again to cancel Eco drive mode.

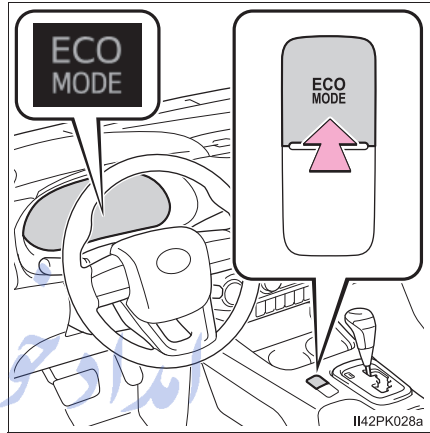

■ Power mode

Use when high levels of response and feeling are desirable, such as when driving in mountainous regions or when overtaking.

Press the “PWR MODE” switch to select power mode.

The “PWR MODE” indicator light will come on.

Press the switch again to cancel power mode.

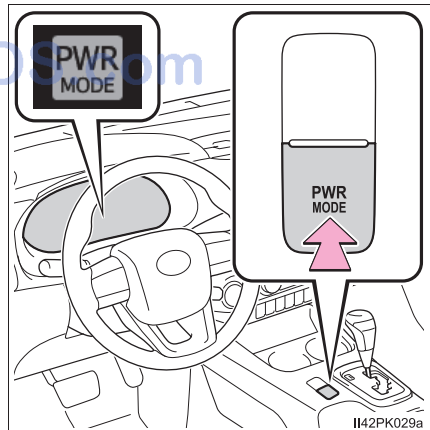

Selecting shift ranges in the S position

To enter S mode, shift the shift lever to S. Shift ranges can be selected by operating the shift lever, allowing you to drive in the shift range of your choosing. The shift range can be selected by the shift lever.

- ① Upshifting
- ② Downshifting

The selected shift range, from 1 to 6, will be displayed in the meter.

The initial shift range in S mode is set automatically to 5 or 4 according to vehicle speed. However, the initial shift range may be set to 3 if AI-SHIFT has operated while the shift lever was in D. (→P. 253)

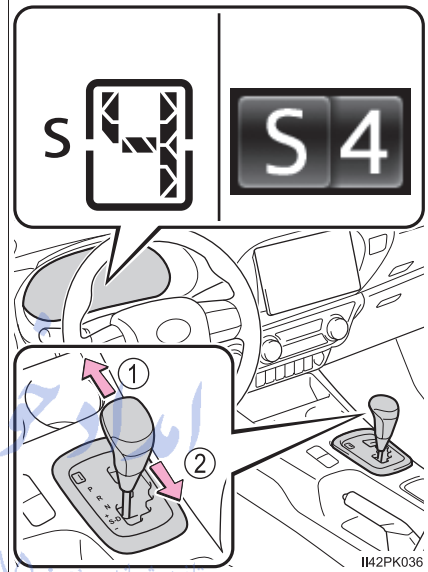

■ Shift ranges and their functions

- Automatically selecting shift ranges between 1 and 6 according to vehicle speed and driving conditions. But the gear is limited according to selected range.
- You can choose from 6 levels of engine braking force.
- A lower shift range will provide greater engine braking force than a higher shift range, and the engine speed will also increase.

■ S mode

When the shift range is 4 or lower, holding the shift lever toward “+” sets the shift range to 6.

■ Downshifting restrictions warning buzzer

To help ensure safety and driving performance, downshifting operation may sometimes be restricted. In some circumstances, downshifting may not be possible even when the shift lever is operated. (A buzzer will sound twice.)

■ Operation of the air conditioning system in Eco drive mode (vehicles with automatic air conditioning system)

Eco drive mode controls the heating/cooling operations and fan speed of the air conditioning system to enhance fuel efficiency (→P. 461). To improve air conditioning performance, adjust the fan speed or turn off Eco drive mode.

■ Deactivation of the driving mode

- Eco drive mode will not be canceled until the “ECO MODE” switch is pressed, even if the engine is turned off after driving in Eco drive mode.
- Power mode will be canceled if the engine is turned off after driving in power mode.

■ When driving with cruise control activated (if equipped)

Even when performing the following actions with the intent of enabling engine braking, engine braking will not activate because cruise control will not be canceled.

- While driving in S mode, downshifting to 5 or 4. (→P. 250)
- When switching the driving mode to power mode while driving in D. (→P. 249)

■ Shift lock system

The shift lock system is a system to prevent accidental operation of the shift lever in starting.

The shift lever can be shifted from P only when the engine switch is in the “ON” position (vehicles without smart entry & start system) or IGNITION ON mode (vehicles with smart entry & start system) and the brake pedal is being depressed.

■ If the shift lever cannot be shifted from P

First, check whether the brake pedal is being depressed.

If the shift lever cannot be shifted with your foot on the brake pedal, there may be a problem with the shift lock system. Have the vehicle inspected by any authorized Toyota dealer or repairer, or another duly qualified and equipped professional immediately.

The following steps may be used as an emergency measure to ensure that the shift lever can be shifted.

Releasing the shift lock:

- 1 Set the parking brake.
- 2 Vehicles without smart entry & start system:
Turn the engine switch to the "LOCK" position.

Vehicles with smart entry & start system:
Turn the engine switch off.

- 3 Depress the brake pedal.
- 4 Pry the cover up with a flathead screwdriver or equivalent tool.

To prevent damage to the cover, cover the tip of the screwdriver with a rag.

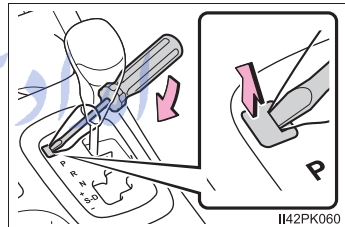

- 5 Press the shift lock override button.
- The shift lever can be shifted while the button is pressed.

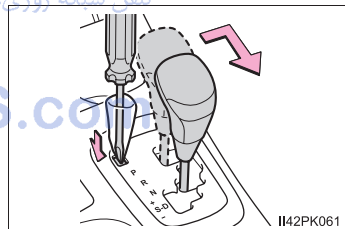

■ If the "S" indicator does not come on or the "D" indicator is displayed even after shifting the shift lever to S

This may indicate a malfunction in the automatic transmission system. Have the vehicle inspected by any authorized Toyota dealer or repairer, or another duly qualified and equipped professional immediately.

■ Transmission protection function

If the tires spin continually when the vehicle becomes stuck in mud, dirt or snow, or if the accelerator pedal is depressed and released repeatedly while driving, the automatic transmission temperature may become too high and the automatic transmission may be damaged.

To avoid damaging the automatic transmission, the system may temporarily lock the gear.

If the automatic transmission temperature falls, the gear locking is canceled and the automatic transmission is returned to the normal operation.

■ If the warning message is displayed

If the automatic transmission fluid temperature warning message is displayed while driving, make sure to return to D position driving and reduce speed by easing off the accelerator pedal. Stop the vehicle in a safe place, shift the shift lever to P and let the engine idle until the warning message goes out.

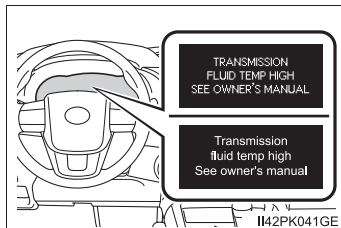

When the warning message goes out, the vehicle can be driven again.

If the warning message does not go out after waiting a while, have your vehicle inspected by any authorized Toyota dealer or repairer, or another duly qualified and equipped professional.

■ AI-SHIFT

The AI-SHIFT automatically selects the suitable gear according to driver performance and driving conditions.

The AI-SHIFT automatically operates when the shift lever is in D. (Shifting the shift lever to S cancels the function.)



WARNING

■ When driving on slippery road surfaces

Do not accelerate or shift gears suddenly.

Sudden changes in engine braking may cause the vehicle to spin or skid, resulting in an accident.

■ To prevent an accident when releasing the shift lock

Before pressing the shift lock override button, make sure to set the parking brake and depress the brake pedal.

If the accelerator pedal is accidentally depressed instead of the brake pedal when the shift lock override button is pressed and the shift lever is shifted out of P, the vehicle may suddenly start, possibly leading to an accident resulting in death or serious injury.

Manual transmission*

Shifting the shift lever

► 5-speed transmission

Fully depress the clutch pedal before operating the shift lever, and then release it slowly.

If it is difficult to shift in reverse, shift the shift lever to N, release the clutch pedal momentarily, and then try again.

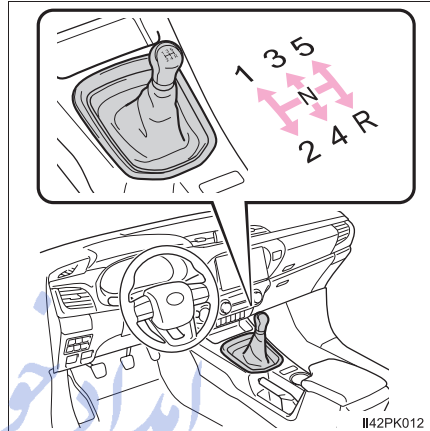

► 6-speed transmission

Fully depress the clutch pedal before operating the shift lever, and then release it slowly.

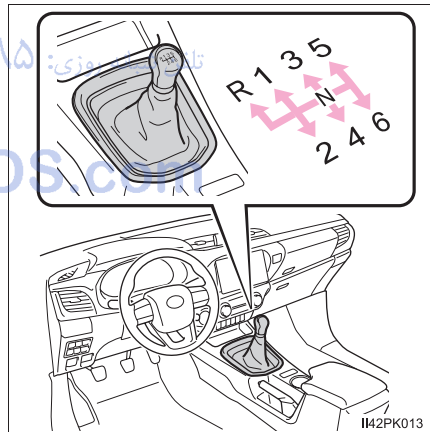

*: If equipped

Selecting the driving mode (if equipped)

The following modes can be selected to suit driving conditions.

■ Eco drive mode

Use Eco drive mode to help achieve low fuel consumption during trips that involve frequent accelerating.

Press the “ECO MODE” switch to select Eco drive mode.

The “ECO MODE” indicator light will come on.

Press the switch again to cancel Eco drive mode.

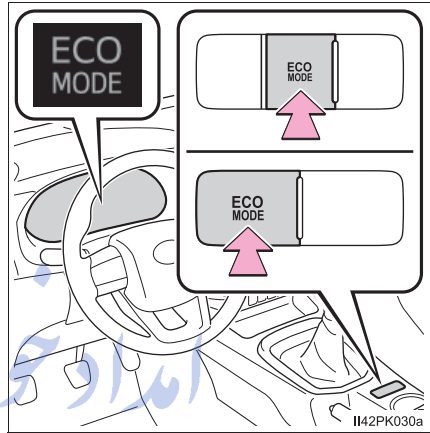

■ Power mode

Use when high levels of response and feeling are desirable, such as when driving in mountainous regions or when overtaking.

Press the “PWR MODE” switch to select power mode.

The “PWR MODE” indicator light will come on.

Press the switch again to cancel power mode.

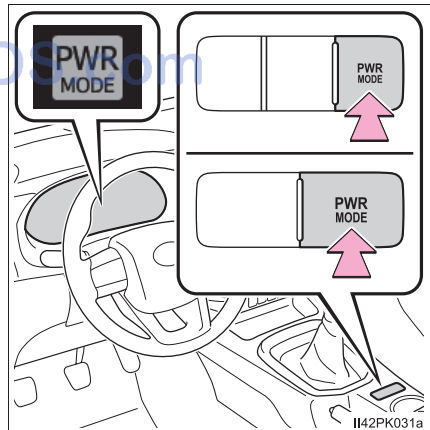

■ Maximum downshifting speeds

Observe the downshifting speeds in the following table to prevent over-revving the engine.

► 5-speed transmission

4WD models (front-wheel drive control switch in H2 or H4):

km/h (mph)

Shift position	Maximum speed			
	1	2	3	4
225/70R17C tires	38 (23)	71 (44)	114 (70)	164 (101)
265/65R17 tires	39 (24)	72 (44)	117 (72)	168 (104)
205R16C tires	39 (24) ^{*1} 37 (22) ^{*2}	73 (45) ^{*1} 69 (42) ^{*2}	118 (73) ^{*1} 112 (69) ^{*2}	170 (105) ^{*1} 160 (99) ^{*2}

*1: TGN126L-DTMLKV and TGN126L-DTMSK models^{*3}

*2: TGN126L-DTMLK models^{*3}

*3: See "Checking your vehicle's model" if you are not sure of which model your vehicle is. (→P. 11)

4WD models (front-wheel drive control switch in L4):

km/h (mph)

Shift position	Maximum speed			
	1	2	3	4
225/70R17C tires	15 (9)	28 (17)	45 (27)	64 (39)
265/65R17 tires	15 (9)	28 (17)	46 (28)	65 (40)
205R16C tires	15 (9)	28 (17) ^{*1} 27 (16) ^{*2}	46 (28) ^{*1} 44 (27) ^{*2}	66 (41) ^{*1} 63 (39) ^{*2}

*1: TGN126L-DTMLKV and TGN126L-DTMSK models^{*3}

*2: TGN126L-DTMLK models^{*3}

*3: See "Checking your vehicle's model" if you are not sure of which model your vehicle is. (→P. 11)

► 6-speed transmission

4WD models (front-wheel drive control switch in H2 or H4):

km/h (mph)

Shift position		Maximum speed				
		1	2	3	4	5
2GD-FTV engine	205R16C tires	34 (21)	67 (41)	113 (70)	163 (101)	170 (105)
	225/70R17C tires	35 (21)	69 (42)	116 (72)	167 (103)	170 (105)
	265/65R17, 265/60R18 tires	36 (22)	70 (43)	118 (73)	170 (105)	170 (105)
2KD-FTV engine	205R16C tires	30 (18)	59 (36)	99 (61)	142 (88)	150 (93)
	225/70R17C tires	29 (18)	57 (35)	97 (60)	139 (86)	150 (93)
	265/65R17 tires	30 (18)	59 (36)	98 (60)	142 (88)	150 (93)

تلفن شبانه روزی: ۰۲۱-۸۸۸۶۲۰۸۵

FarmaSOS.com

4WD models (front-wheel drive control switch in L4):

km/h (mph)

		Maximum speed				
Shift position		1	2	3	4	5
2GD-FTV engine	205R16C tires	13 (8)	26 (16)	44 (27)	64 (39)	82 (50)
	225/70R17C tires	14 (8)	27 (16)	45 (27)	65 (40)	84 (52)
	265/65R17 tires	14 (8)	27 (16)	46 (28)	67 (41)	86 (53)
	265/60R18 tires	14 (8)	28 (17)	46 (28)	67 (41)	86 (53)
2KD-FTV engine	205R16C tires	12 (7)	23 (14)	39 (24)	56 (34)	67 (41)
	225/70R17C tires	11 (6)	22 (13)	38 (23)	54 (33)	66 (41)
	265/65R17 tires	12 (7)	23 (14)	38 (23)	55 (34)	67 (41)

Pre Runner:

تلفن شبانه روزی: ۰۲۱-۸۸۸۶۲۰۸۵

km/h (mph)

		Maximum speed				
Shift position		1	2	3	4	5
225/70R17C tires		35 (21)	69 (42)	116 (72)	167 (103)	175 (108)
265/60R18 tires		36 (22)	70 (43)	118 (73)	171 (106)	175 (108)
265/65R17 tires		36 (22)	70 (43)	118 (73)	170 (105)	175 (108)

■ Operation of the air conditioning system in Eco drive mode (vehicles with automatic air conditioning system)

Eco drive mode controls the heating/cooling operations and fan speed of the air conditioning system to enhance fuel efficiency (→P. 461). To improve air conditioning performance, adjust the fan speed or turn off Eco drive mode.

■ Deactivation of the driving mode

- Eco drive mode will not be canceled until the “ECO MODE” button is pressed, even if the engine is turned off after driving in Eco drive mode.
- Power mode will be canceled if the engine is turned off after driving in power mode.

■ Reverse warning buzzer (6-speed transmission)

A buzzer will sound to alert the driver if the shift lever is shifted to the R position.

امداد خودرو فارما

تلفن شبانه روزی: ۰۲۱-۸۸۸۶۲۰۸۵

FarmaSOS.com

Turn signal lever

Operating instructions

- ① Right turn
- ② Left turn
- ③ Lane change to the right (move the lever partway and release it)

The right hand signals will flash 3 times.

- ④ Lane change to the left (move the lever partway and release it)

The left hand signals will flash 3 times.

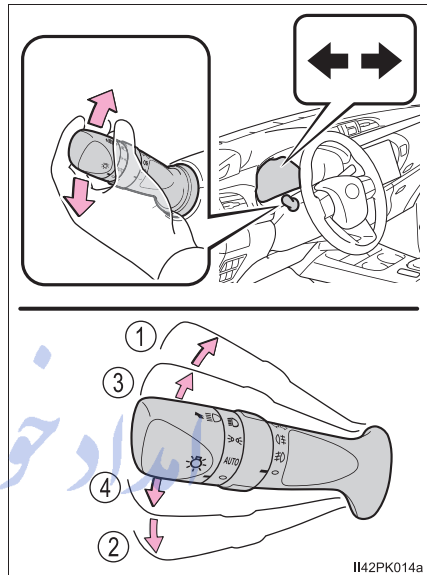

II42PK014a

■ Turn signals can be operated when

- ▶ Vehicles without smart entry & start system

The engine switch is in the "ON" position.

- ▶ Vehicles with smart entry & start system

The engine switch is in IGNITION ON mode.

■ If the indicator flashes faster than usual

Check that a light bulb in the front or rear turn signal lights has not burned out.

■ If the turn signals stop flashing before a lane change has been performed

Operate the lever again.

■ To discontinue flashing of the turn signals during a lane change

Operate the lever in the opposite direction.

■ Customization

The number of times the turn signals flash during a lane change can be changed.

(Customizable features: →P. 648)

Parking brake

① Sets the parking brake

Fully pull the parking brake while depressing the brake pedal. At this time, the parking brake indicator light will come on.

② Releases the parking brake

Slightly raise the lever and lower it completely while pressing the button. At this time, the parking brake indicator light will go off.

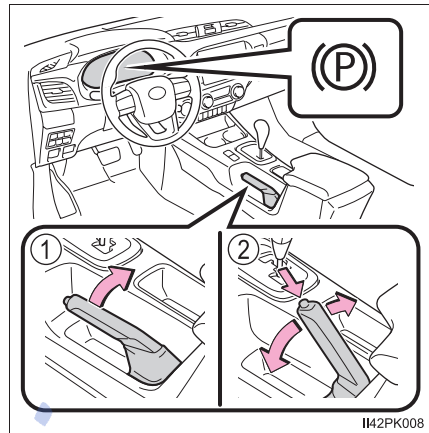

■ Parking the vehicle

→P. 209

■ Parking brake engaged warning buzzer

→P. 572

■ Usage in winter time

→P. 368

⚠ NOTICE

■ Before driving

Fully release the parking brake.

Driving the vehicle with the parking brake set will lead to brake components overheating, which may affect braking performance and increase brake wear.

امداد خودرو فارما

تلفن شبانه روزی: ۰۲۱-۸۸۸۶۲۰۸۵

FarmaSOS.com

Headlight switch

The headlights can be operated manually or automatically.

Operating instructions

Turning the end of the lever turns on the lights as follows:

► Type A

- ① **AUTO** The headlights, front position, tail, license plate, instrument panel and daytime running lights (if equipped) (→P. 266) turn on and off automatically (when the engine switch is in the “ON” position [vehicles without smart entry & start system] or IGNITION ON mode [vehicles with smart entry & start system]).

- ②  The front position, tail, license plate and instrument panel lights turn on.

- ③  The headlights and all lights listed above turn on.

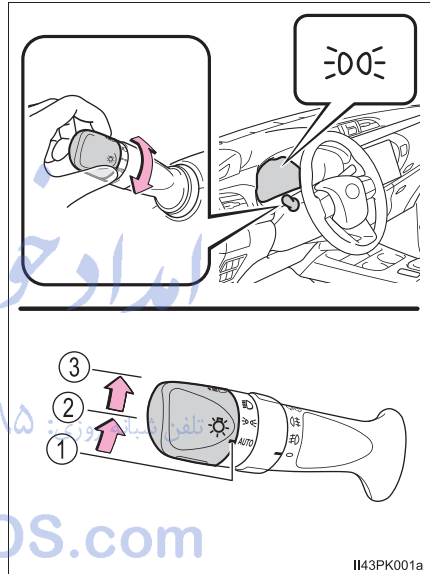

II43PK001a

► Type B

- ① ○ Vehicles without daytime running light system: Off.
Vehicles with daytime running light system: The daytime running lights turn on. (→P. 266)

- ② **AUTO** (if equipped) The headlights, front position, tail, license plate, instrument panel and daytime running lights (if equipped) (→P. 266) turn on and off automatically (when the engine switch is in the "ON" position [vehicles without smart entry & start system] or IGNITION ON mode [vehicles with smart entry & start system]).

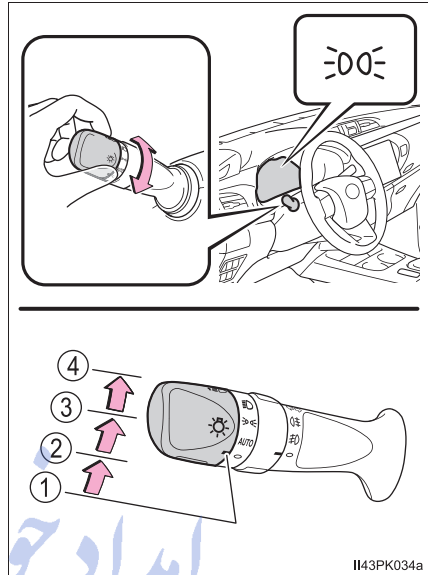

- ③ ☰ Vehicles with daytime running light system: The front position, tail, license plate and instrument panel lights turn on.
- ④ ☰ The headlights and all lights listed above turn on.

Turning on the high beam headlights

- ① With the headlights on, push the lever away from you to turn on the high beams.

Pull the lever toward you to the center position to turn the high beams off.

- ② Pull the lever toward you and release it to flash the high beams once.

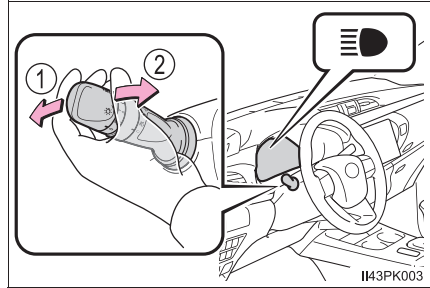

You can flash the high beams with the headlights on or off.

Manual headlight leveling dial (if equipped)

The level of the headlights can be adjusted according to the number of passengers and the loading condition of the vehicle.

- ① Raises the level of the headlights
- ② Lowers the level of the headlights

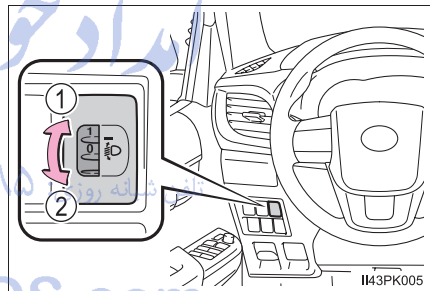

■ Guide to dial settings

Occupancy and luggage load conditions		Dial position		
Occupants	Luggage load	Single-cab and smart-cab models	Double-cab models	
			Left-hand drive vehicles	Right-hand drive vehicles
Driver	None	0	0	0
Driver	Full luggage loading	2.5	2.5 ^{*1} 3 ^{*2}	3

*1: Vehicles with Heavy Duty Suspension. *3

*2: Vehicles without Heavy Duty Suspension. *3

*3: Contact any authorized Toyota dealer or repairer, or another duly qualified and equipped professional, if you are not sure of which specifications your vehicle is equipped with.

تلفن شبانه روزی: ۰۲۱-۸۸۸۶۲۰۸۵

FarmaSOS.com

Follow me home system (if equipped)

This system allows the headlights and front position lights to be turned on for 30 seconds when the engine switch is turned to the “LOCK” position (vehicles without smart entry & start system) or off (vehicles with smart entry & start system).

Pull the lever toward you and release it with the light switch is in **AUTO** or **o** after turning the engine switch to the “LOCK” position (vehicles without smart entry & start system) or off (vehicles with smart entry & start system).

Pull the lever toward you and release it again to turn off the lights.

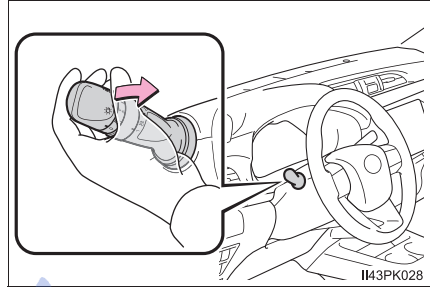

Daytime running light system (if equipped)

To make your vehicle more visible to other drivers during daytime driving, the daytime running lights turn on automatically whenever the engine is started with the headlight switch in **AUTO** or **o**. (Illuminate brighter than the front position lights.) The daytime running light system is not designed for use at night.

Headlight control sensor (if equipped)

The sensor may not function properly if an object is placed on the sensor, or anything that blocks the sensor is affixed to the windshield.

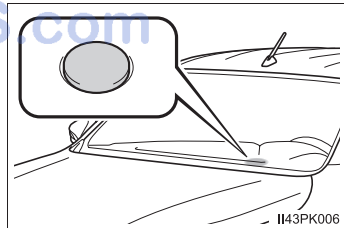

Doing so interferes with the sensor detecting the level of ambient light and may cause the automatic headlight system to malfunction.



■ Automatic light off system (if equipped)

- ▶ Models for model code destination V* and Blank* (except for Kazakhstan, Morocco and Egypt)

The lights turn off after the engine switch is turned to the “LOCK” position (vehicles without smart entry & start system) or off (vehicles with smart entry & start system) and the driver’s door is opened.

To turn the lights on again, turn the engine switch to the “ON” position (vehicles without smart entry & start system) or to IGNITION ON mode (vehicles with smart entry & start system), or turn the light switch to AUTO or  once and then back to  or .



- ▶ Models for model code destination W*, Kazakhstan, Morocco and Egypt

When the light switch is in  or .

The headlights and front fog lights turn off after the engine switch is turned to the “LOCK” position (vehicles without smart entry & start system) or off (vehicles with smart entry & start system).

When the light switch is in AUTO:

The lights turn off after the engine switch is turned to the “LOCK” position (vehicles without smart entry & start system) or off (vehicles with smart entry & start system).

To turn the lights on again, turn the engine switch to the “ON” position (vehicles without smart entry & start system) or to IGNITION ON mode (vehicles with smart entry & start system), or turn the light switch to AUTO or  once and then back to  or .

*: See “Checking your vehicle’s model” if you are not sure of which model your vehicle is. (→P. 11)

■ Light reminder buzzer (if equipped)

- ▶ Vehicles without smart entry & start system

A buzzer sounds when the engine switch is turned to the “LOCK” position, the key is removed and the driver’s door is opened while the lights are turned on.

- ▶ Vehicles with smart entry & start system



A buzzer sounds when the engine switch is turned off and the driver’s door is opened while the lights are turned on.

■ Battery-saving function

- ▶ Models for model code destination V* and Blank* (except for Kazakhstan, Morocco and Egypt)

In order to prevent the battery of the vehicle from discharging, if the headlights and/or tail lights are on when the engine switch is turned to the “LOCK” position (vehicles without smart entry & start system) or off (vehicles with smart entry & start system), the battery-saving function will operate and automatically turn off all the lights after approximately 20 minutes.

- ▶ Models for model code destination W*, Kazakhstan, Morocco and Egypt

In order to prevent the battery of the vehicle from discharging, if the light switch is in  or  position when the engine switch is turned to the “LOCK” position (vehicles without smart entry & start system) or off (vehicles with smart entry & start system), the battery-saving function will operate and automatically turn off all the lights after approximately 20 minutes.

When any of the following are performed, the battery-saving function is canceled once and then reactivated. All the lights will turn off automatically 20 minutes after the battery-saving function has been reactivated:

- When the headlight switch is operated
- When a door is closed once and then opened

*: See “Checking your vehicle’s model” if you are not sure of which model your vehicle is. (→P. 11)

■ Automatic headlight leveling system (if equipped)

The level of the headlights is automatically adjusted according to the number of passengers and the loading condition of the vehicle to ensure that the headlights do not interfere with other road users.

■ Customization

Settings (e.g. light sensor sensitivity) can be changed.
(Customizable features: →P. 648)



NOTICE

■ To prevent battery discharge

Do not leave the lights on longer than necessary when the engine is not running.

Fog light switch*

The fog lights secure excellent visibility in difficult driving conditions, such as in rain and fog.

■ Front fog light switch (if equipped)

- ① ○ Turns the front fog lights off
- ② ƒ Turns the front fog lights on

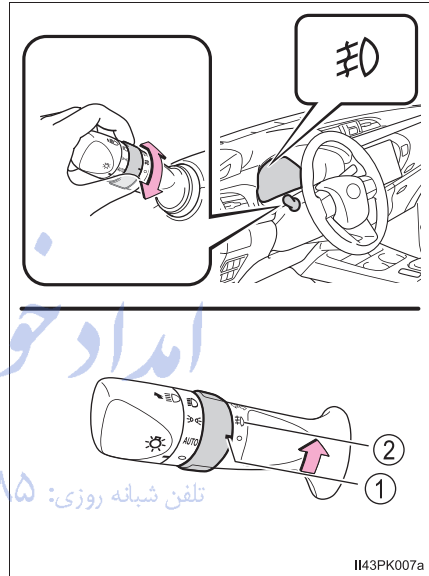

■ Rear fog light switch (if equipped)

☞ Turns the rear fog light on

Releasing the switch ring returns it to ○ .

Operating the switch ring again turns the rear fog light off.

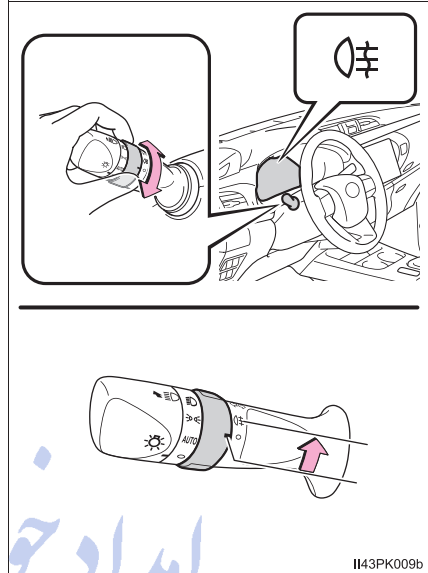

■ Front and rear fog light switch (if equipped)

① ○ Turns the front and rear fog lights off

② ☞ Turns the front fog lights on

③ ☞☞ Turns both front and rear fog lights on

Releasing the switch ring returns it to ☞.

Operating the switch ring again turns only the rear fog lights off.

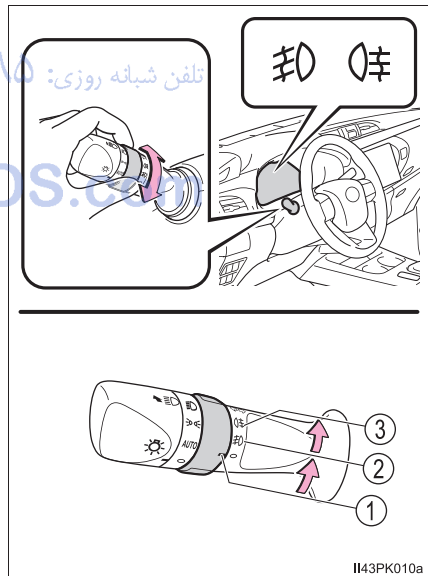

■ Fog lights can be used when

The headlights or front position lights are turned on.

Windshield wipers and washer

Operating the wiper lever

The wiper operation is selected by moving the lever as follows.

■ Windshield wipers without intermittent operation

- ① Low speed operation
- ② High speed operation
- ③ Temporary operation

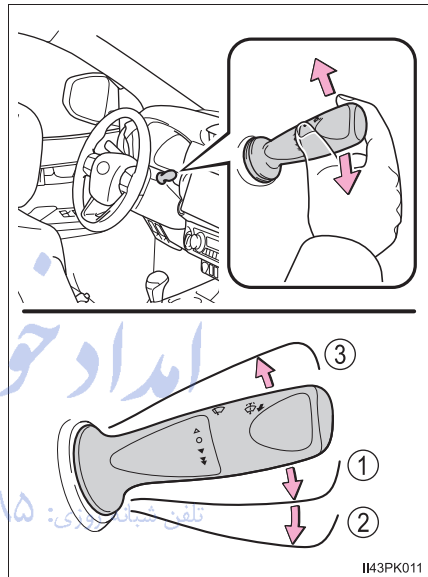

- ④ Washer operation

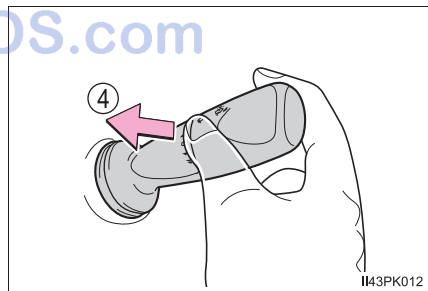

■ Windshield wipers with intermittent operation

- ① Intermittent operation
- ② Low speed operation
- ③ High speed operation
- ④ Temporary operation

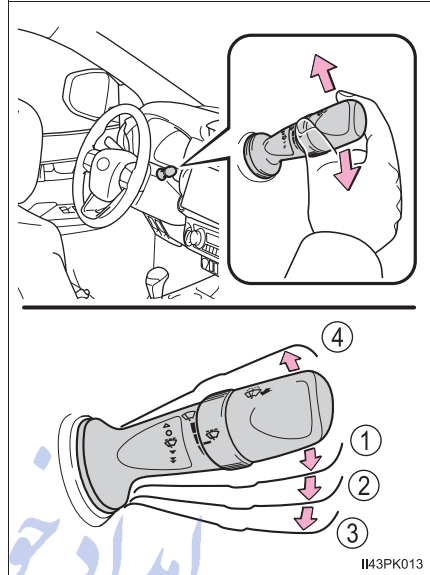

If equipped, wiper intervals can be adjusted when intermittent operation is selected.

- ⑤ Increases the intermittent windshield wiper frequency
- ⑥ Decreases the intermittent windshield wiper frequency

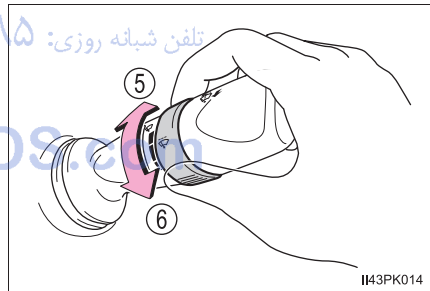

⑦ Washer/wiper dual operation

The wipers will automatically operate a couple of times after the washer squirts.

If the headlights are on, the headlight cleaners will operate once.

And then, the headlight cleaners will operate every five times you pull the lever. (if equipped)

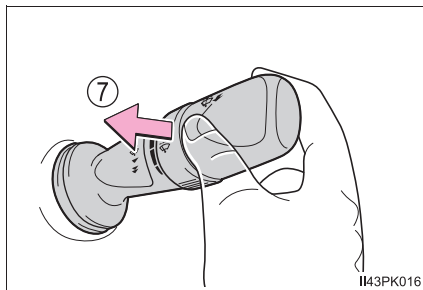

■ The windshield wipers and washer can be operated when

The engine switch is in the “ON” position (vehicles without smart entry & start system) or IGNITION ON mode (vehicles with smart entry & start system).

■ If no windshield washer fluid sprays

Check that the washer nozzles are not blocked if there is washer fluid in the windshield washer fluid reservoir.

⚠ WARNING

■ Caution regarding the use of washer fluid

When it is cold, do not use the washer fluid until the windshield becomes warm. The fluid may freeze on the windshield and cause low visibility. This may lead to an accident, resulting in death or serious injury.

⚠ NOTICE

■ When the windshield is dry

Do not use the wipers, as they may damage the windshield.

■ When the washer fluid tank is empty

Do not operate the switch continually as the washer fluid pump may over-heat.

■ When a nozzle becomes blocked

In this case, contact any authorized Toyota dealer or repairer, or another duly qualified and equipped professional.

Do not try to clear it with a pin or other object. The nozzle will be damaged.

Opening the fuel tank cap

Perform the following steps to open the fuel tank cap:

Before refueling the vehicle

- Close all the doors and windows, and turn the engine switch to the “LOCK” position (vehicles without smart entry & start system) or off (vehicles with smart entry & start system).
- Confirm the type of fuel.

■ Fuel types

→P. 645

■ Fuel tank opening for unleaded gasoline (gasoline engine)

To help prevent incorrect fueling, your vehicle has a fuel tank opening that only accommodates the special nozzle on unleaded fuel pumps.

امداد خودرو فارما
تلفن شبانه روزی: ۰۲۱-۸۸۸۶۲۰۸۵

FarmaSOS.com

 **WARNING**
■ When refueling the vehicle

Observe the following precautions while refueling the vehicle. Failure to do so may result in death or serious injury.

- After exiting the vehicle and before opening the fuel cap, touch an unpainted metal surface to discharge any static electricity. It is important to discharge static electricity before refueling because sparks resulting from static electricity can cause fuel vapors to ignite while refueling.
- Type A (→P. 276) only: Always hold the grips on the fuel tank cap and turn it slowly to remove it.
A whooshing sound may be heard when the fuel tank cap is loosened. Wait until the sound cannot be heard before fully removing the cap. In hot weather, pressurized fuel may spray out the filler neck and cause injury.
- Do not allow anyone that has not discharged static electricity from their body to come close to an open fuel tank.
- Do not inhale vaporized fuel.
Fuel contains substances that are harmful if inhaled.
- Do not smoke while refueling the vehicle.
Doing so may cause the fuel to ignite and cause a fire.
- Do not return to the vehicle or touch any person or object that is statically charged.
This may cause static electricity to build up, resulting in a possible ignition hazard.

■ When refueling

Observe the following precautions to prevent fuel overflowing from the fuel tank:

- Securely insert the fuel nozzle into the fuel filler neck.
- Stop filling the tank after the fuel nozzle automatically clicks off.
- Do not top off the fuel tank.

 NOTICE

Refueling

- Do not spill fuel during refueling.
Doing so may damage the vehicle, such as causing the emission control system to operate abnormally or damaging fuel system components or the vehicle's painted surface.
- Vehicles with DPF system:
Use the specified fuel. If fuel other than the specified fuel is used, white smoke may be continuously emitted from the exhaust pipe during regenerating the filter. (→P. 364)

Opening the fuel tank cap
Type A

- 1 Pull up the opener to open the fuel filler door.

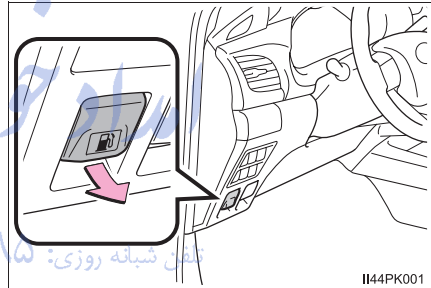

- 2 Turn the fuel tank cap slowly to remove it and hang it on the back of the fuel filler door.

▶ Without over fender

▶ With over fender

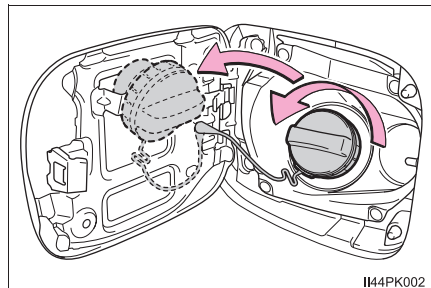
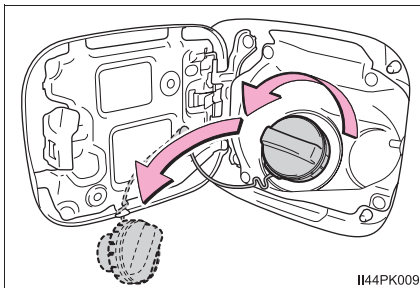

■ Type B

- 1 To unlock the fuel tank cap, insert the key and turn it counterclockwise.

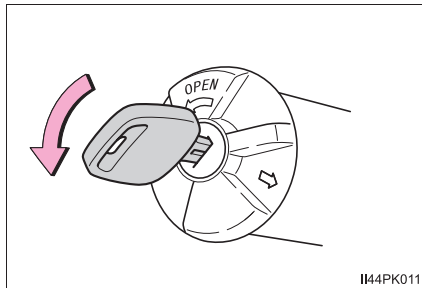

- 2 Turn the fuel tank cap slowly to open.
Make sure not to hold and turn the key.

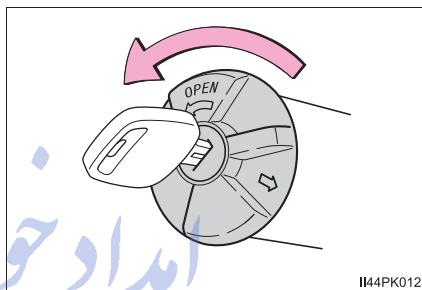

امداد خودرو فارما

Closing the fuel tank cap

■ Type A

After refueling, turn the fuel tank cap until you hear a click. Once the cap is released, it will turn slightly in the opposite direction.

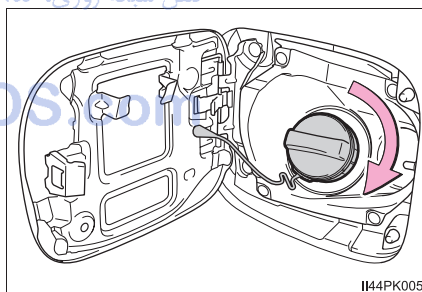

تلفن: شبانه روزی: ۰۲۱-۸۸۸۶۲۰۸۵

Farmasoft.com

Toyota Safety Sense*

The Toyota Safety Sense consists of the following drive assist systems and contributes to a safe and comfortable driving experience:

◆ PCS (Pre-Crash Safety system)*

→P. 287

◆ LDA (Lane Departure Alert)*

→P. 300

◆ RSA (Road Sign Assist)*

→P. 309

⚠ WARNING

■ Toyota Safety Sense

The Toyota Safety Sense is designed to operate under the assumption that the driver will drive safely, and is designed to help reduce the impact to the occupants and the vehicle in the case of a collision or assist the driver in normal driving conditions.

As there is a limit to the degree of recognition accuracy and control performance that this system can provide, do not overly rely on this system. The driver is always responsible for paying attention to the vehicle's surroundings and driving safely.

Vehicle data recording

The pre-crash safety system is equipped with a sophisticated computer that will record certain data, such as:

- Accelerator status
- Brake status
- Vehicle speed
- Operation status of the pre-crash safety system functions
- Information (such as the distance and relative speed between your vehicle and the vehicle ahead or other objects)

The pre-crash safety system does not record conversations, sounds or pictures.

● Data usage

Toyota may use the data recorded in this computer to diagnose malfunctions, conduct research and development, and improve quality.

Toyota will not disclose the recorded data to a third party except:

- With the consent of the vehicle owner or with the consent of the lessee if the vehicle is leased
- In response to an official request by the police, a court of law or a government agency
- For use by Toyota in a lawsuit
- For research purposes where the data is not tied to a specific vehicle or vehicle owner

Sensors

Two types of sensors, located behind the front grille and windshield, detect information necessary to operate the drive assist systems.

- ① Radar sensor
- ② Camera sensor

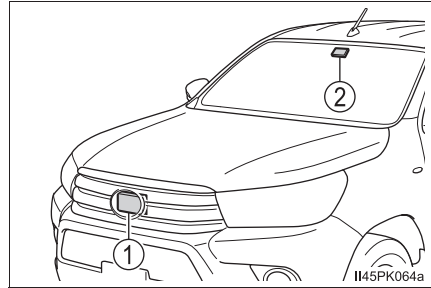

امداد خودرو فارما

تلفن شبانه روزی: ۰۲۱-۸۸۸۶۲۰۸۵

FarmaSOS.com

⚠ WARNING

■ To avoid malfunction of the radar sensor

Observe the following precautions.

Otherwise, the radar sensor may not operate properly, possibly leading to an accident resulting in death or serious injury.

● Keep the radar sensor and front grille emblem clean at all times.

- ① Radar sensor
- ② Front grille emblem

If the front of the radar sensor or the front or back of the front grille emblem is dirty or covered with water droplets, snow, etc., clean it.

Clean the radar sensor and front grille emblem with a soft cloth so you do not mark or damage them.

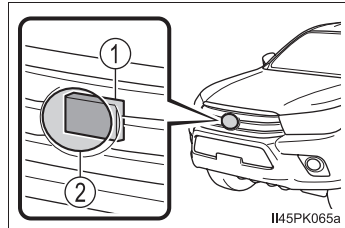

- Do not attach accessories, stickers (including transparent stickers) or other items to the radar sensor, front grille emblem or surrounding area.
- Do not subject the radar sensor or surrounding area to a strong impact. If the radar sensor, front grille, or front bumper has been subjected to a strong impact, have the vehicle inspected by any authorized Toyota dealer or repairer, or another duly qualified and equipped professional.
- Do not disassemble the radar sensor.
- Do not modify or paint the radar sensor, front grille emblem or surrounding area.
- If the radar sensor, front grille, or front bumper needs to be removed and installed, or replaced, contact any authorized Toyota dealer or repairer, or another duly qualified and equipped professional.

⚠ WARNING

■ To avoid malfunction of the camera sensor

Observe the following precautions.

Otherwise, the camera sensor may not operate properly, possibly leading to an accident resulting in death or serious injury.

- Keep the windshield clean at all times.
 - If the windshield is dirty or covered with an oily film, water droplets, snow, etc., clear the windshield.
 - If a glass coating agent is applied to the windshield, it will still be necessary to use the windshield wipers to remove water droplets, etc. from the area of the windshield in front of the camera sensor.
 - If the inner side of the windshield where the camera sensor is installed is dirty, contact any authorized Toyota dealer or repairer, or another duly qualified and equipped professional.
- Do not install an antenna or attach stickers (including transparent stickers) or other items to the area of the windshield in front of the camera sensor (shaded area in the illustration).

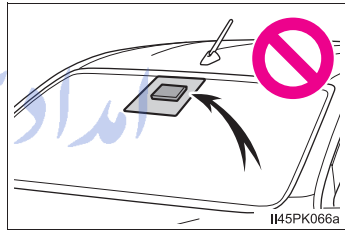

- If the part of the windshield in front of the camera sensor is fogged up or covered with condensation or ice, use the windshield defogger to remove the fog, condensation or ice. (→P. 449, 458)
- If water droplets cannot be properly removed from the area of the windshield in front of the camera sensor by the windshield wipers, replace the wiper insert or wiper blade.

If the wiper inserts or wiper blades need to be replaced, contact any authorized Toyota dealer or repairer, or another duly qualified and equipped professional.
- Do not attach window tinting to the windshield.

 **WARNING**

- Replace the windshield if it is damaged or cracked.
If the windshield needs to be replaced, contact any authorized Toyota dealer or repairer, or another duly qualified and equipped professional.
- Do not get the camera sensor wet.
- Do not allow bright lights to shine into the camera sensor.
- Do not dirty or damage the camera sensor.
When cleaning the inside of the windshield, do not allow glass cleaner to contact the lens. Also, do not touch the lens.
If the lens is dirty or damaged, contact any authorized Toyota dealer or repairer, or another duly qualified and equipped professional.
- Do not subject the camera sensor to a strong impact.
- Do not change the installation position or direction of the camera sensor or remove it.
- Do not disassemble the camera sensor.
- Do not install an electronic device or device that emits strong electric waves near the camera sensor.
- Do not modify any components of the vehicle around the camera sensor (inside rear view mirror, etc.) or ceiling.
- Do not attach any accessories that may obstruct the camera sensor to the hood, front grille or front bumper. Contact any authorized Toyota dealer or repairer, or another duly qualified and equipped professional for details.
- If a surfboard or other long object is to be mounted on the roof, make sure that it will not obstruct the camera sensor.
- Do not modify the headlights or other lights.

■ Certification

1. **CE 0682**

2. Link to the original DoC

<http://continentalautomotive-approvals.com/>

Česky [Czech]:	ADC Automotive Distance Control Systems GmbH tímto prohlašuje, že tento ARSTM 4-B je ve shodě se základními požadavky a dalšími příslušnými ustanoveními směrnice 1999/5/ES.
Dansk [Danish]:	Undertegnede ADC Automotive Distance Control Systems GmbH erklærer herved, at følgende udstyr ARSTM 4-B overholder de væsentlige krav og øvrige relevante krav i direktiv 1999/5/EF.
Deutsch [German]:	Hiermit erkläre ADC Automotive Distance Control Systems GmbH , dass sich das Gerät ARSTM 4-B in Übereinstimmung mit den grundlegenden Anforderungen und den übrigen einschlägigen Bestimmungen der Richtlinie 1999/5/EG befindet.
Eesti [Estonian]:	Käesolevaga kinnitab ADC Automotive Distance Control Systems GmbH seadme ARSTM 4-B vastavust direktiivi 1999/5/EÜ põhinõuetele ja nimetatud direktiivist tulenevatele teistele asjakohastele sätetele.
English:	Hereby, ADC Automotive Distance Control Systems GmbH , declares that this ARSTM 4-B is in compliance with the essential requirements and other relevant provisions of Directive 1999/5/EC.
Español [Spanish]:	Por medio de la presente ADC Automotive Distance Control Systems GmbH declara que el ARSTM 4-B cumple con los requisitos esenciales y cualesquiera otras disposiciones aplicables o exigibles de la Directiva 1999/5/CE.
Ελληνική [Greek]:	ΜΕ ΤΗΝ ΠΑΡΟΥΣΑ ADC Automotive Distance Control Systems GmbH ΔΗΛΩΝΕΙ ΟΤΙ ARSTM 4-B ΣΥΜΜΟΡΦΩΝΕΤΑΙ ΠΡΟΣ ΤΙΣ ΟΥΣΙΩΔΕΙΣ ΑΠΑΙΤΗΣΕΙΣ ΚΑΙ ΤΙΣ ΛΟΙΠΕΣ ΣΧΕΤΙΚΕΣ ΔΙΑΤΑΞΕΙΣ ΤΗΣ ΟΔΗΓΙΑΣ 1999/5/ΕΚ.
Français [French]:	Par la présente ADC Automotive Distance Control Systems GmbH déclare que l'appareil ARSTM 4-B est conforme aux exigences essentielles et aux autres dispositions pertinentes de la directive 1999/5/CE.
Italiano [Italian]:	Con la presente ADC Automotive Distance Control Systems GmbH dichiara che questo ARSTM 4-B è conforme ai requisiti essenziali ed alle altre disposizioni pertinenti stabilite dalla direttiva 1999/5/CE.
Latviski [Latvian]:	Ar šo ADC Automotive Distance Control Systems GmbH deklarē, ka ARSTM 4-B atbilst Direktīvas 1999/5/EK būtiskajām prasībām un citiem ar to saistītajiem noteikumiem.
Lietuvių [Lithuanian]:	Šiuo ADC Automotive Distance Control Systems GmbH deklaruoją, kad šis ARSTM 4-B atitinka esminius reikalavimus ir kitas 1999/5/EB Direktyvos nuostatas.

Nederlands [Dutch]:	Hierbij verklaart ADC Automotive Distance Control Systems GmbH dat het toestel ARSTM 4-B in overeenstemming is met de essentiële eisen en de andere relevante bepalingen van richtlijn 1999/5/EG.
Malti [Maltese]:	Hawnhekk, ADC Automotive Distance Control Systems GmbH , jiddikjara li dan ARSTM 4-B jikkonforma mal-htigijiet essenzjali u ma provvedimenti oħrajn relevanti li hemm fid-Dirrettiva 1999/5/EC.
Magyar [Hungarian]:	Alulírott, ADC Automotive Distance Control Systems GmbH nyilatkozik, hogy a ARSTM 4-B megfelel a vonatkozó alapvető követelményeknek és az 1999/5/EC irányelv egyéb előírásainak.
Polski [Polish]:	Niniejszym ADC Automotive Distance Control Systems GmbH oświadcza, że ARSTM 4-B jest zgodny z zasadniczymi wymogami oraz pozostałymi stosownymi postanowieniami Dyrektywy 1999/5/EC
Português [Portuguese]:	ADC Automotive Distance Control Systems GmbH declara que este ARSTM 4-B está conforme com os requisitos essenciais e outras disposições da Directiva 1999/5/CE.
Slovensko [Slovenian]:	ADC Automotive Distance Control Systems GmbH izjavlja, da je ta ARSTM 4-B v skladu z bistvenimi zahtevami in ostalimi relevantnimi določili direktive 1999/5/ES.
Slovensky [Slovak]:	ADC Automotive Distance Control Systems GmbH týmto vyhlasuje, že ARSTM 4-B spĺňa základné požiadavky a všetky príslušné ustanovenia Smernice 1999/5/ES.
Suomi [Finnish]:	ADC Automotive Distance Control Systems GmbH vakuuttaa täten että ARSTM 4-B tyyppinen laite on direktiivin 1999/5/EY oleellisten vaatimusten ja sitä koskevien direktiivin muiden ehtojen mukainen.
Svenska [Swedish]:	Härmed intygar ADC Automotive Distance Control Systems GmbH att denna ARSTM 4-B står i överensstämmelse med de väsentliga egenskapskrav och övriga relevanta bestämmelser som framgår av direktiv 1999/5/EG.
Íslenska (Icelandic):	Hér með lýsir ADC Automotive Distance Control Systems GmbH yfir því að ARSTM 4-B er í samræmi við grunnkröfur og aðrar kröfur, sem gerðar eru í tilskipun 1999/5/EC
Norsk [Norwegian]:	ADC Automotive Distance Control Systems GmbH erklærer herved at utstyret ARSTM 4-B er i samsvar med de grunnleggende krav og øvrige relevante krav i direktiv 1999/5/EF.

PCS (Pre-Crash Safety system)*

The pre-crash safety system uses a radar sensor and camera sensor to detect vehicles and pedestrians in front of your vehicle. When the system determines that the possibility of a frontal collision with a vehicle or pedestrian is high, a warning operates to urge the driver to take evasive action and the potential brake pressure is increased to help the driver avoid the collision. If the system determines that the possibility of a frontal collision with a vehicle or pedestrian is extremely high, the brakes are automatically applied to help avoid the collision or help reduce the impact of the collision.

The pre-crash safety system can be disabled/enabled and the warning timing can be changed. (→P. 291)

امداد خودرو فارما

تلفن شبانه روزی: ۰۲۱-۸۸۸۶۲۰۸۵

FarmaSOS.com

◆ Pre-crash warning

When the system determines that the possibility of a frontal collision is high, a buzzer will sound and a warning message will be displayed on the multi-information display to urge the driver to take evasive action.

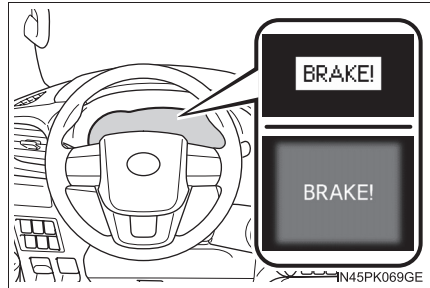

◆ Pre-crash brake assist

When the system determines that the possibility of a frontal collision is high, the system applies greater braking force in relation to how strongly the brake pedal is depressed.

◆ Pre-crash braking

When the system determines that the possibility of a frontal collision is high, the system warns the driver. If the system determines that the possibility of a frontal collision is extremely high, the brakes are automatically applied to help avoid the collision or reduce the collision speed. تلفن شبانه روزی: ۰۸۵-۸۸۸۶۲۰۲۱

 **WARNING**
■ Limitations of the pre-crash safety system

- The driver is solely responsible for safe driving. Always drive safely, taking care to observe your surroundings.
Do not use the pre-crash safety system instead of normal braking operations under any circumstances. This system will not prevent collisions or lessen collision damage or injury in every situation. Do not overly rely on this system. Failure to do so may lead to an accident, resulting in death or serious injury.
- Although this system is designed to help avoid a collision or help reduce the impact of the collision, its effectiveness may change according to various conditions, therefore the system may not always be able to achieve the same level of performance.
Read the following conditions carefully. Do not overly rely on this system and always drive carefully.
 - Conditions under which the system may operate even if there is no possibility of a collision: →P. 293
 - Conditions under which the system may not operate properly: →P. 296
- Do not attempt to test the operation of the pre-crash safety system yourself, as the system may not operate properly, possibly leading to an accident.

■ Pre-crash braking

- When the pre-crash braking function is operating, a large amount of braking force will be applied.
- If the vehicle is stopped by the operation of the pre-crash braking function, the pre-crash braking function operation will be canceled after approximately 2 seconds. Depress the brake pedal as necessary.
- The pre-crash braking function may not operate if certain operations are performed by the driver. If the accelerator pedal is being depressed strongly or the steering wheel is being turned, the system may determine that the driver is taking evasive action and possibly prevent the pre-crash braking function from operating.
- In some situations, while the pre-crash braking function is operating, operation of the function may be canceled if the accelerator pedal is depressed strongly or the steering wheel is turned and the system determines that the driver is taking evasive action.
- If the brake pedal is being depressed, the system may determine that the driver is taking evasive action and possibly delay the operation timing of the pre-crash braking function.

 **WARNING****■ When to disable the pre-crash safety system**

In the following situations, disable the system, as it may not operate properly, possibly leading to an accident resulting in death or serious injury:

- When the vehicle is being towed
- When your vehicle is towing another vehicle
- When transporting the vehicle via truck, boat, train or similar means of transportation
- When the vehicle is raised on a lift with the engine running and the tires are allowed to rotate freely
- When inspecting the vehicle using a drum tester such as a chassis dynamometer or speedometer tester, or when using an on vehicle wheel balancer
- When a strong impact is applied to the front bumper or front grille, due to an accident or other reasons
- If the vehicle cannot be driven in a stable manner, such as when the vehicle has been in an accident or is malfunctioning
- When the vehicle is driven in a sporty manner or off-road
- When the tires are not properly inflated
- When the tires are very worn
- When tires of a size other than specified are installed
- When tire chains are installed
- When a compact spare tire or an emergency tire puncture repair kit is used
- If equipment (snow plow, etc.) that may obstruct the radar sensor or camera sensor is temporarily installed to the vehicle

Changing settings of the pre-crash safety system

■ Disabling the pre-crash safety system

Press the PCS switch for 3 seconds or more.

The PCS warning light will turn on and a message will be displayed on the multi-information display.

To enable the system, press the PCS switch again.

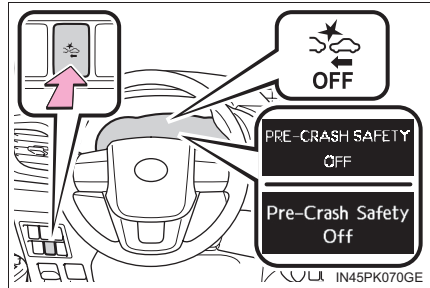

The system is enabled each time the engine switch is turned to the “ON” position (vehicles without smart entry & start system) or IGNITION ON mode (vehicles with smart entry & start system).

■ Changing the pre-crash warning timing

Press the PCS switch to display the current warning timing on the multi-information display. Each time the PCS switch is pressed with the warning timing displayed, the warning timing will change as follows.

The operation timing setting is retained when the engine switch is turned to the “LOCK” position (vehicles without smart entry & start system) or off (vehicles with smart entry & start system).

① Far

The warning will begin to operate earlier than with the default timing.

② Middle

This is the default setting.

③ Near

The warning will begin to operate later than with the default timing.

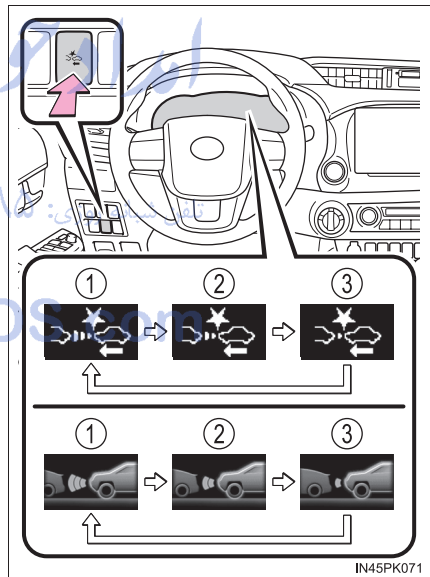

■ Operational conditions

The pre-crash safety system is enabled and the system determines that the possibility of a frontal collision with a vehicle or pedestrian is high.

Each function is operational at the following speeds:

- Pre-crash warning:
 - Vehicle speed is between approximately 10 and 180 km/h (7 and 110 mph). (For detecting a pedestrian, vehicle speed is between approximately 10 and 80 km/h [7 and 50 mph]. For detecting a stationary vehicle, vehicle speed is between approximately 10 and 90 km/h [7 and 55 mph].)
 - The relative speed between your vehicle and the vehicle or pedestrian ahead is approximately 10 km/h (7 mph) or more.
- Pre-crash brake assist:
 - Vehicle speed is between approximately 30 and 180 km/h (19 and 110 mph). (For detecting a pedestrian, vehicle speed is between approximately 30 and 80 km/h [19 and 50 mph]. For detecting a stationary vehicle, vehicle speed is between approximately 30 and 90 km/h [19 and 55 mph].)
 - The relative speed between your vehicle and the vehicle or pedestrian ahead is approximately 30 km/h (19 mph) or more.
- Pre-crash braking:
 - Vehicle speed is between approximately 10 and 180 km/h (7 and 110 mph). (For detecting a pedestrian, vehicle speed is between approximately 10 and 80 km/h [7 and 50 mph]. For detecting a stationary vehicle, vehicle speed is between approximately 10 and 90 km/h [7 and 55 mph].)
 - The relative speed between your vehicle and the vehicle or pedestrian ahead is approximately 10 km/h (7 mph) or more.

The system may not operate in the following situations:

- If a battery terminal has been disconnected and reconnected and then the vehicle has not been driven for a certain amount of time
- If the shift lever is in R
- If VSC is disabled (only the pre-crash warning function will be operational)
- If the low speed four-wheel drive indicator light is illuminated (only the pre-crash warning function will be operational)
- If the PCS warning light is flashing or illuminated

■ Pedestrian detection function

The pre-crash safety system detects pedestrians based on the size, profile, and motion of a detected object. However, a pedestrian may not be detected depending on the surrounding brightness and the motion, posture, and angle of the detected object, preventing the system from operating properly. (→P. 298)

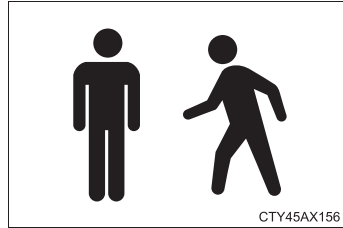

■ Cancellation of the pre-crash braking

If either of the following occur while the pre-crash braking function is operating, it will be canceled:

- The accelerator pedal is depressed strongly.
- The steering wheel is turned sharply or abruptly.

■ Conditions under which the system may operate even if there is no possibility of a collision

- In some situations such as the following, the system may determine that there is a possibility of a frontal collision and operate.
 - When passing a vehicle or pedestrian
 - When changing lanes while overtaking a preceding vehicle
 - When overtaking a preceding vehicle that is changing lanes
 - When overtaking a preceding vehicle that is making a left/right turn

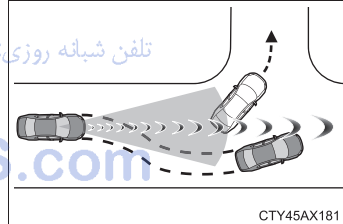

- When passing a vehicle in an oncoming lane that is stopped to make a right/left turn

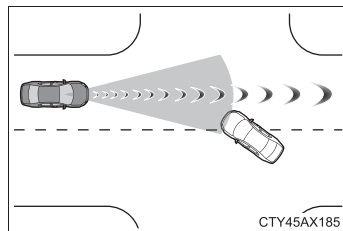

- When driving on a road where relative location to vehicle ahead in an adjacent lane may change, such as on a winding road

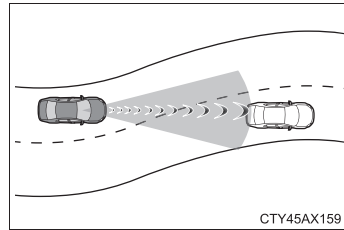

- When rapidly closing on a vehicle ahead
- If the front of the vehicle is raised or lowered, such as when the road surface is uneven or undulating
- When approaching objects on the roadside, such as guardrails, utility poles, trees, or walls
- When there is a vehicle, pedestrian, or object by the roadside at the entrance of a curve

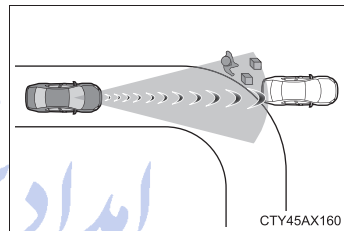

- When driving on a narrow path surrounded by a structure, such as in a tunnel or on an iron bridge
- When there is a metal object (manhole cover, steel plate, etc.), steps, or a protrusion on the road surface or roadside
- When a crossing pedestrian approaches very close to the vehicle

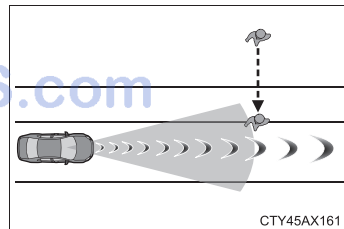

- When passing through a place with a low structure above the road (low ceiling, traffic sign, etc.)

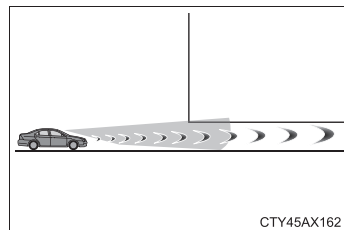

- When passing under an object (billboard, etc.) at the top of an uphill road

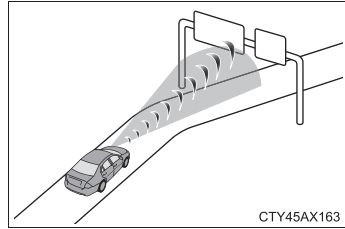

- When rapidly closing on an electric toll gate barrier, parking area barrier, or other barrier that opens and closes
- When using an automatic car wash
- When driving through or under objects that may contact the vehicle, such as thick grass, tree branches, or a banner

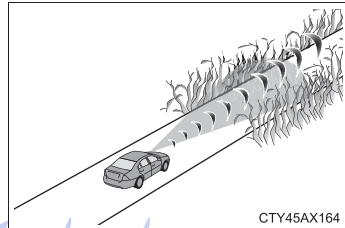

- When the vehicle is hit by water, snow, dust, etc. from a vehicle ahead
- When driving through steam or smoke
- When there are patterns or paint on the road or a wall that may be mistaken for a vehicle or pedestrian
- When driving near an object that reflects radio waves, such as a large truck or guardrail
- When driving near a TV tower, broadcasting station, electric power plant, or other location where strong radio waves or electrical noise may be present

FarmaSOS.com

■ Situations in which the system may not operate properly

- In some situations such as the following, a vehicle may not be detected by the radar sensor and camera sensor, preventing the system from operating properly:

- If an oncoming vehicle is approaching your vehicle
- If a vehicle ahead is a motorcycle or bicycle
- When approaching the side or front of a vehicle
- If a preceding vehicle has a small rear end, such as an unloaded truck
- If a preceding vehicle has a low rear end, such as a low bed trailer

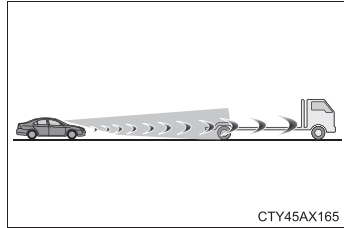

- If a vehicle ahead is carrying a load which protrudes past its rear bumper
- If a vehicle ahead has extremely high ground clearance

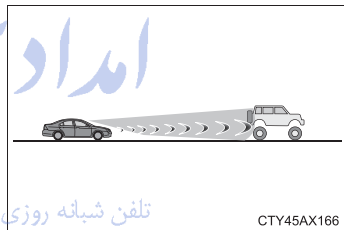

- If a vehicle ahead is irregularly shaped, such as a tractor or side car
- If the sun or other light is shining directly on a vehicle ahead
- If a vehicle cuts in front of your vehicle or emerges from beside a vehicle
- If a vehicle ahead makes an abrupt maneuver (such as sudden swerving, acceleration or deceleration)
- When suddenly cutting behind a preceding vehicle
- When a vehicle ahead is not directly in front of your vehicle

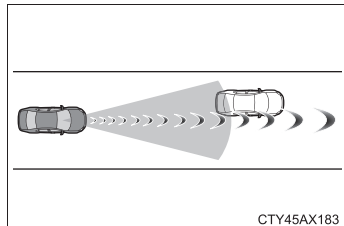

- When driving in inclement weather such as heavy rain, fog, snow or a sandstorm
- When the vehicle is hit by water, snow, dust, etc. from a vehicle ahead
- When driving through steam or smoke
- When driving in a place where the surrounding brightness changes suddenly, such as at the entrance or exit of a tunnel
- When a very bright light, such as the sun or the headlights of oncoming traffic, shines directly into the camera sensor
- When the surrounding area is dim, such as at dawn or dusk, or while at night or in a tunnel
- After the engine has started the vehicle has not been driven for a certain amount of time
- While making a left/right turn and for a few seconds after making a left/right turn
- While driving on a curve and for a few seconds after driving on a curve
- If your vehicle is skidding
- If the front of the vehicle is raised or lowered

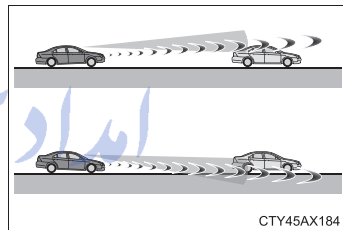

- If the wheels are misaligned
 - If a wiper blade is blocking the camera sensor
 - The vehicle is wobbling.
 - The vehicle is being driven at extremely high speeds.
 - When driving on a hill
 - If the radar sensor or camera sensor is misaligned
- In some situations such as the following, sufficient braking force may not be obtained, preventing the system from performing properly:
 - If the braking functions cannot operate to their full extent, such as when the brake parts are extremely cold, extremely hot, or wet
 - If the vehicle is not properly maintained (brakes or tires are excessively worn, improper tire inflation pressure, etc.)
 - When the vehicle is being driven on a gravel road or other slippery surface

- Some pedestrians such as the following may not be detected by the radar sensor and camera sensor, preventing the system from operating properly:
 - Pedestrians shorter than approximately 1 m (3.2 ft.) or taller than approximately 2 m (6.5 ft.)
 - Pedestrians wearing oversized clothing (a rain coat, long skirt, etc.), making their silhouette obscure
 - Pedestrians who are carrying large baggage, holding an umbrella, etc., hiding part of their body
 - Pedestrians who are bending forward or squatting
 - Pedestrians who are pushing a stroller, wheelchair, bicycle or other vehicle
 - Groups of pedestrians which are close together
 - Pedestrians who are wearing white and look extremely bright
 - Pedestrians in the dark, such as at night or while in a tunnel
 - Pedestrians whose clothing appears to be nearly the same color or brightness as their surroundings
 - Pedestrians near walls, fences, guardrails, or large objects
 - Pedestrians who are on a metal object (manhole cover, steel plate, etc.) on the road
 - Pedestrians who are walking fast
 - Pedestrians who are changing speed abruptly
 - Pedestrians running out from behind a vehicle or a large object
 - Pedestrians who are extremely close to the side of the vehicle (outside rear view mirror, etc.)

تلفن شبانه روزی: ۰۲۱-۸۸۸۶۲۰۸۵

FarmaSOS.com

■ If the PCS warning light flashes and a warning message is displayed on the multi-information display

The pre-crash safety system may be temporarily unavailable or there may be a malfunction in the system.

- In the following situations, the warning light will turn off, the message will disappear and the system will become operational when normal operating conditions return:
 - When the radar sensor or camera sensor or the area around either sensor is hot, such as in the sun
 - When the radar sensor or camera sensor or the area around either sensor is cold, such as in an extremely cold environment
 - When the radar sensor or front grille emblem is dirty or covered with snow, etc.
 - When the part of the windshield in front of the camera sensor is fogged up or covered with condensation or ice.
(Defogging the windshield: →P. 449, 458)
 - If the camera sensor is obstructed, such as when the hood is open or a sticker is attached to the windshield near the camera sensor
- If the PCS warning light continues to flash or the warning message does not disappear, the system may be malfunctioning. Have the vehicle inspected by any authorized Toyota dealer or repairer, or another duly qualified and equipped professional immediately.

■ If VSC is disabled

- If VSC is disabled (→P. 355), the pre-crash brake assist and pre-crash braking functions are also disabled.
- The PCS warning light will turn on and “VSC TURNED OFF PRE-CRASH BRAKE SYSTEM UNAVAILABLE”/“VSC Turned Off Pre-Crash Brake System Unavailable” will be displayed on the multi-information display.

LDA (Lane Departure Alert)*

Summary of functions

When driving on roads with white (yellow) lines, this function alerts the driver when the vehicle might depart from its lane.

The LDA system recognizes visible white (yellow) lines with the camera sensor on the upper portion of the front windshield.

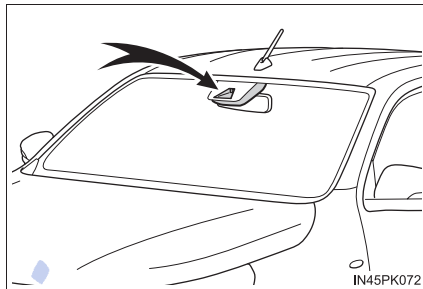

Functions included in LDA system

◆ Lane departure alert function

When the system determines that the vehicle might depart from its lane, a warning is displayed on the multi-information display and the warning buzzer sounds to alert the driver.

When the warning buzzer sounds, check the surrounding road situation and carefully operate the steering wheel to move the vehicle back to the center of the lane.

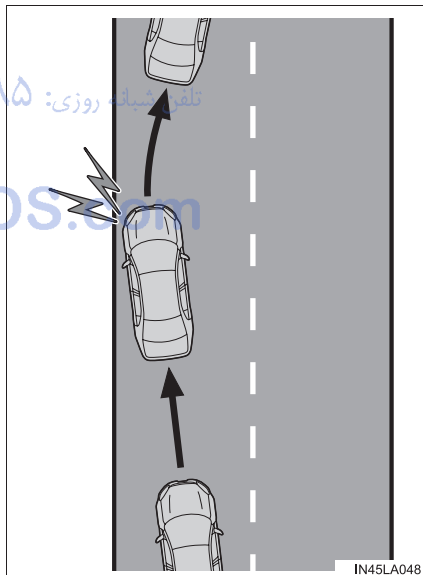

*: If equipped

◆ Vehicle sway warning function

When the vehicle is swaying or appears as if it may depart from its lane multiple times, the warning buzzer sounds and a message is displayed on the multi-information display to alert the driver.

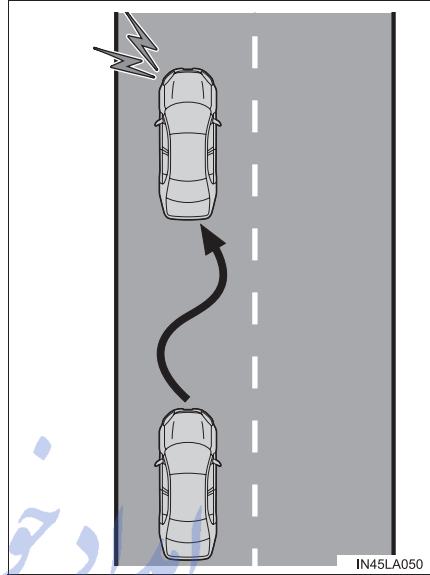

⚠ WARNING

■ Before using LDA system

Do not rely solely upon the LDA system. The LDA system does not automatically drive the vehicle or reduce the amount of attention that must be paid to the area in front of the vehicle. The driver must always assume full responsibility for driving safely by paying careful attention to the surrounding conditions and operating the steering wheel to correct the path of the vehicle. Also, the driver must take adequate breaks when fatigued, such as from driving for a long period of time.

Failure to perform appropriate driving operations and pay careful attention may lead to an accident, resulting in death or serious injury.

■ To avoid operating LDA system by mistake

When not using the LDA system, use the LDA switch to turn the system off.

 **WARNING****■ Situations unsuitable for LDA system**

Do not use the LDA system in the following situations.

The system may not operate properly and lead to an accident, resulting in death or serious injury.

- A spare tire, tire chains, etc., are equipped.
- Objects or patterns that could be mistaken for white (yellow) lines are present on the side of the road (guardrails, curbs, reflective poles, etc.).
- Vehicle is driven on a snow-covered road.
- White (yellow) lines are difficult to see due to rain, snow, fog, dust, etc.
- Asphalt repair marks, white (yellow) line marks, etc., are present due to road repair.
- Vehicle is driven in a temporary lane or restricted lane due to construction work.
- Vehicle is driven in a construction zone.

■ Preventing LDA system malfunctions and operations performed by mistake

- Do not modify the headlights or place stickers, etc., on the surface of the lights.
- Do not modify the suspension etc. If the suspension etc. needs to be replaced, contact any authorized Toyota dealer or repairer, or another duly qualified and equipped professional. تلفن شبانه روزی: ۱۵۰۰۰۰۰۰۰۰۰
- Do not install or place anything on the hood or grille. Also, do not install a grille guard (bull bars, kangaroo bar, etc.).
- If your windshield needs repairs, contact any authorized Toyota dealer or repairer, or another duly qualified and equipped professional.

Turning LDA system on

Press the LDA switch to turn the LDA system on.

The LDA indicator illuminates.

Press the LDA switch again to turn the LDA system off.

When the LDA system is turned on or off, operation of the LDA system continues in the same condition the next time the engine is started.

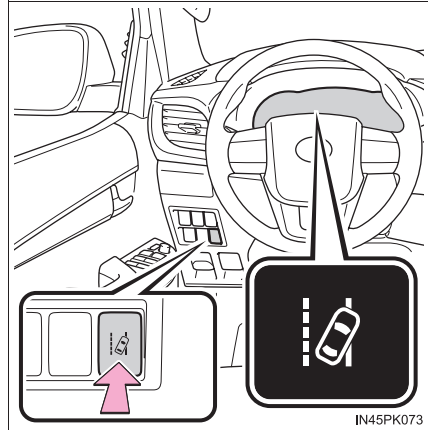

Indications on multi-information display

① LDA indicator

The illumination condition of the indicator informs the driver of the system operation status.

- ▶ Vehicles with multi-information display type A

Illuminated in green:
LDA system is operating.

Illuminated in green with the lane departure alert function display on:
Lane departure alert function is

operating.

- ▶ Vehicles with multi-information display type B

Illuminated in green:
LDA system is operating.

Flashing in yellow:
Lane departure alert function is

operating.

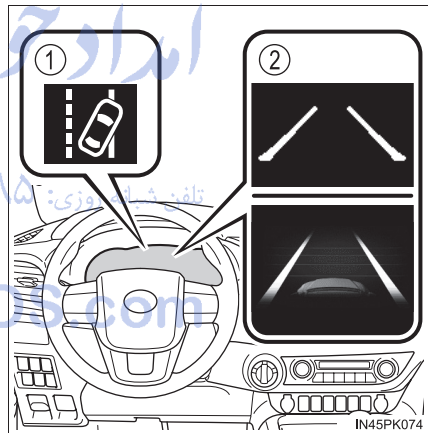

② Lane departure alert function display

Vehicles with multi-information display type A:

▶ Solid lane lines are shown



Indicates that the system is recognizing white (yellow) lines. When the vehicle departs from its lane, the white line displayed on the side the vehicle departs from flashes.

▶ Thin lines are shown

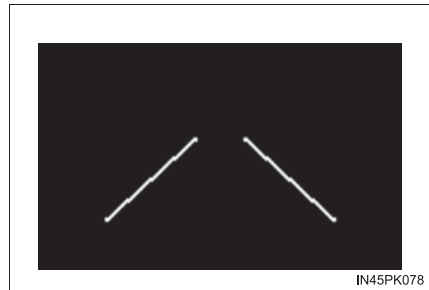

Indicates that the system is not able to recognize white (yellow) lines or is temporarily canceled.

Vehicles with multi-information display type B:

▶ Inside of displayed white lines is white

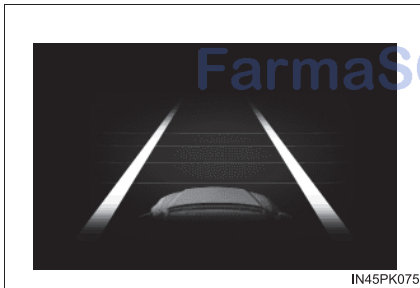

Indicates that the system is recognizing white (yellow) lines. When the vehicle departs from its lane, the white line displayed on the side the vehicle departs from flashes orange.

▶ Inside of displayed white lines is black



Indicates that the system is not able to recognize white (yellow) lines or is temporarily canceled.

■ Operation conditions of each function

● Lane departure alert function

This function operates when all of the following conditions are met.

- LDA is turned on.
- Vehicle speed is approximately 50 km/h (32 mph) or more.
- System recognizes white (yellow) lines.
- Width of traffic lane is approximately 3 m (9.8 ft.) or more.
- Turn signal lever is not operated.
- Vehicle is driven on a straight road or around a gentle curve with a radius of more than approximately 150 m (492 ft.).
- No system malfunctions are detected. (→P. 307)

● Vehicle sway warning function

This function operates when all of the following conditions are met.

- LDA is turned on.
- Vehicle speed is approximately 50 km/h (32 mph) or more.
- Width of traffic lane is approximately 3 m (9.8 ft.) or more.
- No system malfunctions are detected. (→P. 307)

■ Temporary cancellation of functions

When operation conditions are no longer met, a function may be temporarily canceled. However, when the operation conditions are met again, operation of the function is automatically restored. (→P. 305)

■ Lane departure alert function

The warning buzzer may be difficult to hear due to external noise, audio playback, etc.

■ White (yellow) lines are only on one side of road

The LDA system will not operate for the side on which white (yellow) lines could not be recognized.

■ Conditions in which functions may not operate properly

In the following situations, the camera sensor may not detect white (yellow) lines and various functions may not operate normally.

- There are shadows on the road that run parallel with, or cover, the white (yellow) lines.
- The vehicle is driven in an area without white (yellow) lines, such as in front of a tollgate or checkpoint, or at an intersection, etc.
- The white (yellow) lines are cracked, or “Raised pavement marker” or stones are present.
- The white (yellow) lines cannot be seen or are difficult to see due to sand, etc.
- The vehicle is driven on a road surface that is wet due to rain, puddles, etc.
- The traffic lines are yellow (which may be more difficult to recognize than lines that are white).
- The white (yellow) lines cross over a curb, etc.
- The vehicle is driven on a bright surface, such as concrete.
- The vehicle is driven on a surface that is bright due to reflected light, etc.
- The vehicle is driven in an area where the brightness changes suddenly, such as at the entrances and exits of tunnels, etc.
- Light from the headlights of an oncoming vehicle, the sun, etc., enters the camera.
- The vehicle is driven where the road diverges, merges, etc.
- The vehicle is driven on a slope.
- The vehicle is driven on a road which tilts left or right, or a winding road.
- The vehicle is driven on an unpaved or rough road.
- The vehicle is driven around a sharp curve.
- The traffic lane is excessively narrow or wide.
- The vehicle is extremely tilted due to carrying heavy luggage or having improper tire pressure.
- The distance to the preceding vehicle is extremely short.
- The vehicle is moving up and down a large amount due to road conditions during driving (poor roads or road seams).
- The headlight lenses are dirty and emit a faint amount of light at night, or the beam axis has deviated.
- The vehicle has just changed lanes or crossed an intersection.

■ Warning message

If the following warning message is displayed on the multi-information display, follow the appropriate troubleshooting procedure.

Warning message	Details/Actions
“LDA MALFUNCTION VISIT YOUR DEALER”/ “LDA malfunction Visit your dealer”	The system may not be operating properly. → Have the vehicle inspected at any authorized Toyota dealer or repairer, or another duly qualified and equipped professional.
“FORWARD CAMERA SYSTEM UNAVAILABLE CLEAN WINDSHIELD”/ “Forward Camera System Unavailable Clean Windshield”	Dirt, rain, condensation, ice, snow, etc., are present on the windshield in front of the camera sensor. → Turn the LDA system off, remove any dirt, rain, condensation, ice, snow, etc., from the windshield, and then turn the LDA system back on.
“FORWARD CAMERA SYSTEM UNAVAILABLE”/ “Forward Camera System Unavailable”	The operation conditions of the camera sensor (temperature, etc.) are not met. → When the operation conditions of the camera sensor (temperature, etc.) are met, the LDA system will become available. Turn the LDA system off, wait for a little while, and then turn the LDA system back on.

Warning message	Details/Actions
<p>“LDA UNAVAILABLE”/ “LDA unavailable”</p>	<p>The LDA system is temporarily canceled due to a malfunction in a sensor other than the camera sensor. → Turn the LDA system off and follow the appropriate troubleshooting procedures for the warning message. Afterward, drive the vehicle for a short time, and then turn the LDA system back on.</p>
<p>“LDA UNAVAILABLE BELOW APPROX 50km/h”/ “LDA unavailable Below approx 50km/h”</p>	<p>The LDA system cannot be used as the vehicle speed is less than approximately 50 km/h (32 mph). → Drive the vehicle at approximately 50 km/h (32 mph) or more.</p>
<p>“LDA UNAVAILABLE BELOW APPROX 32MPH”/ “LDA unavailable Below approx 32MPH”</p>	<p>→ Drive the vehicle at approximately 50 km/h (32 mph) or more.</p>
<p>“LDA UNAVAILABLE AT CURRENT SPEED”/ “LDA unavailable at current speed”</p>	<p>The LDA system cannot be used as the vehicle speed is too high. → Reduce the vehicle speed.</p>

If a different warning message is displayed, follow the instructions displayed on the screen.

RSA (Road Sign Assist)*

Summary of function

RSA recognizes specific road signs using the camera sensor and provides information to the driver via the multi-information display.

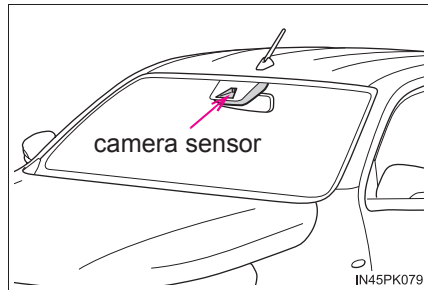

If the system judges that the vehicle is being driven over the speed limit, performing prohibited actions, etc., in relation to the recognized road signs, it alerts the driver using a warning display and warning buzzer*.

*: This setting needs to be customized.

⚠ WARNING

■ Before using the RSA

Do not rely solely upon the RSA system. RSA is a system which supports the driver by providing information, but it is not a replacement for a driver's own vision and awareness. Drive safely by always paying careful attention to the traffic rules.

Inappropriate or negligent driving could lead to an unexpected accident.

Indication on the multi-information display

After the camera sensor recognizes a sign, it is displayed on the multi-information display when the vehicle passes the sign.

- When the driving assist system information is selected, a maximum of 3 signs can be displayed. (→P. 136)

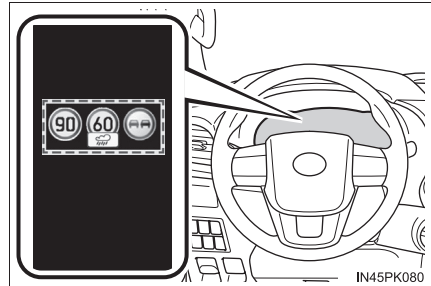

- When other than the driving assist system information is selected, a speed limit sign, a highway sign or an all canceled sign can be displayed. (→P. 136)

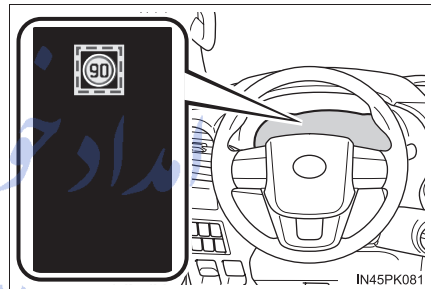











A no overtaking sign and a speed limit sign with supplemental mark are not displayed. However, if signs other than speed limit signs are recognized, they are mentioned in a stack under the current speed limit sign.

Types of recognized road signs

The following types of road signs, including electronic signs and blinking signs, are recognized.

A non-official (not meeting the Vienna Convention) or a recently introduced traffic sign may not be recognized.

Type		Multi-information display
Speed limit begins/ends* ¹		
Highway entrance/exit		
Speed limit with supplemental mark (Displayed simultaneously with speed limit)  (Display example)	Wet	
	Rain	
	Ice	
	On/off ramp* ²	
	Supplemental mark exists (Contents not recognized)	
No overtaking begins/ends		

Type	Multi-information display
<p style="text-align: center;">All canceled (All restrictions canceled. Returns to default road regulation.)</p>	

*1: A speed limit sign with a value greater than 130 may not be recognized and a wrong speed limit may be displayed.

*2: If the turn signal indicator is not operated when changing lanes, the mark does not display.

Warning display

In the following situations, the RSA system alerts the driver using a warning display.

- When the vehicle speed exceeds the speed warning threshold applied to the speed limit of the sign displayed on the multi-information display, the sign color becomes inverted.
- If it is detected that your vehicle is overtaking when a no overtaking sign is displayed on the multi-information display, the sign flashes.

Depending on the situation, traffic environment (traffic direction, speed, unit) may be detected incorrectly and a warning display may not operate properly.

Automatic turn-off of RSA sign display

One or more signs automatically turn off in the following situations.

- A new sign is not recognized for a certain distance.
- The road changes due to a left or right turn, etc.

Conditions in which the function may not operate or detect correctly

In the following situations, RSA does not operate normally and may not recognize signs, display the incorrect sign, etc. However, this does not indicate a malfunction.





- The camera sensor is misaligned due to a strong impact being applied to the sensor, etc.
- Dirt, snow, stickers, etc., are on the windshield near the camera sensor.
- In inclement weather such as heavy rain, fog, snow or sand storms
- Light from an oncoming vehicle, the sun, etc., enters the camera sensor.
- The sign is dirty, faded, tilted or bent, and if an electronic sign, the contrast is poor.
- All or part of the sign is hidden by the leaves of a tree, a pole, etc.

- The sign is only visible to the camera sensor for a short amount of time.
- The driving scene (turning, lane change, etc.) is judged incorrectly.
- Even if it is a sign not appropriate for the currently traveled lane, such a sign exists directly after a freeway branches, or in an adjacent lane just before merging.
- Stickers are attached to the rear of the preceding vehicle.
- A sign resembling a system compatible sign is recognized.
- The vehicle is driven in a country with a different direction of traffic.
- Side road speed signs may be detected and displayed (if positioned in sight of the camera sensor) while the vehicle is traveling on the main road.
- Roundabout exit road speed signs may be detected and displayed (if positioned in sight of the camera sensor) while traveling on a roundabout.
- The speed information displayed on the meter and that displayed on the Navigation system (if equipped) may be different due to the Navigation system or Multimedia system using map data.

■ When driving vehicle in country with different speed unit

Since RSA recognizes signs based on the set unit of the meter, it is necessary to change the set unit of the meter. Adjust the set unit of the meter to the speed unit of signs in the current location. (→P. 649)

■ Turning the system on/off

Use the meter control switches to select  while the vehicle is stopped and press , and select  and press . تلفن شبانه روزی: ۰۲۰۰۰۰۰۰۰۰۰۰

■ Speed limit sign display

If the engine switch was last turned to the "LOCK" position (vehicles without smart entry & start system) or off (vehicles with smart entry & start system) while a speed limit sign was displayed on the multi-information display, the same sign displays again when the engine switch is turned to the "ON" position (vehicles without smart entry & start system) or IGNITION ON mode (vehicles with smart entry & start system).

■ Customization

Setting (e.g. speeding warning threshold) can be changed. (Customizable feature: →P. 648)

Cruise control*

Summary of functions

Use the cruise control to maintain a set speed without depressing the accelerator pedal.

- ① Indicators
- ② Cruise control switch

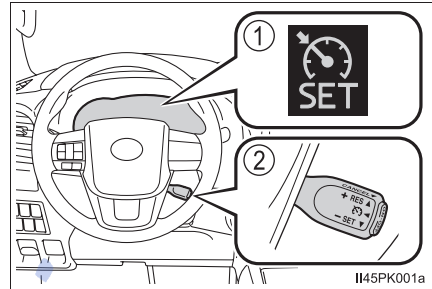

Setting the vehicle speed

- 1 Press the "ON-OFF" button to activate the cruise control.

Cruise control indicator will come on.

Press the button again to deactivate the cruise control.

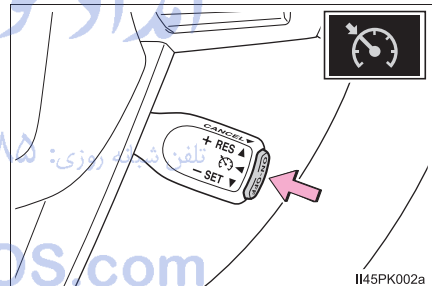

- 2 Accelerate or decelerate the vehicle to the desired speed, and push the lever down to set the speed.

"SET" indicator will come on.

The vehicle speed at the moment the lever is released becomes the set speed.

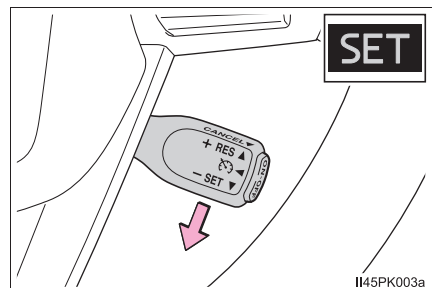

*: If equipped

Adjusting the set speed

To change the set speed, operate the lever until the desired set speed is obtained.

- ① Increases the speed
- ② Decreases the speed

Fine adjustment: Momentarily move the lever in the desired direction.

Large adjustment: Hold the lever in the desired direction.

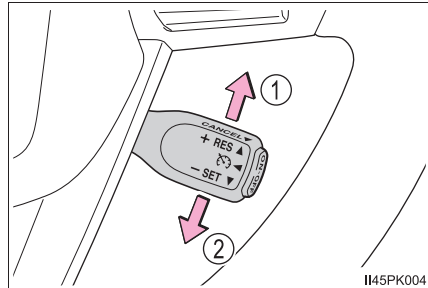

The set speed will be increased or decreased as follows:

Fine adjustment: By approximately 1.6 km/h (1 mph) each time the lever is operated.

Large adjustment: The set speed can be increased or decreased continually until the lever is released.

Canceling and resuming the constant speed control

- ① Pulling the lever toward you cancels the constant speed control.

The speed setting is also canceled when the brakes are applied or the clutch pedal (manual transmission only) is depressed.

- ② Pushing the lever up resumes the constant speed control.

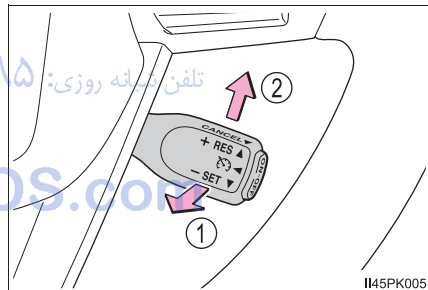

Resuming is available when the vehicle speed is more than approximately 40 km/h (25 mph).

■ Cruise control can be set when

- The shift lever is in the D or range 4 or higher of S has been selected. (vehicles with automatic transmission)
- Vehicle speed is above approximately 40 km/h (25 mph).

■ Accelerating after setting the vehicle speed

- The vehicle can be accelerated normally. After acceleration, the set speed resumes.
- Even without canceling the cruise control, the set speed can be increased by first accelerating the vehicle to the desired speed and then pushing the lever down to set the new speed.

■ Automatic cruise control cancelation

Cruise control will stop maintaining the vehicle speed in any of the following situations:

- Actual vehicle speed falls more than approximately 16 km/h (10 mph) below the preset vehicle speed.
At this time, the memorized set speed is not retained.
- Actual vehicle speed is below approximately 40 km/h (25 mph).
- VSC is activated. (if equipped)
- 4WD models: The front-wheel drive control switch is switched between H2 and H4.
- TRC or A-TRC is activated for a period of time.
- When the VSC, TRC or A-TRC system is turned off. (if equipped)

■ If the warning message for the cruise control is shown on the multi-information display

Press the "ON-OFF" button once to deactivate the system, and then press the button again to reactivate the system.

If the cruise control speed cannot be set or if the cruise control cancels immediately after being activated, there may be a malfunction in the cruise control system. Have the vehicle inspected by any authorized Toyota dealer or repairer, or another duly qualified and equipped professional.

 **WARNING****■ To avoid operating the cruise control by mistake**

Switch the cruise control off using the “ON-OFF” button when not in use.

■ Situations unsuitable for cruise control

Do not use cruise control in any of the following situations.

Doing so may result in loss of control and could cause an accident resulting in death or serious injury.

- In heavy traffic
- On roads with sharp bends
- On winding roads
- On slippery roads, such as those covered with rain, ice or snow
- On steep hills
Vehicle speed may exceed the set speed when driving down a steep hill.
- When your vehicle is towing a trailer (models for model code destination W*) or during emergency towing

*: See “Checking your vehicle’s model” if you are not sure of which model your vehicle is. (→P. 11)

تلفن شبانه روزی: ۰۲۱-۸۸۸۶۲۰۸۵

FarmaSOS.com

Rear view monitor system*

The rear view monitor system assists the driver by displaying an image of the view behind the vehicle with fixed guide lines while backing up, for example while parking.

The screen illustrations used in this text are intended as examples, and may differ from the image that is actually displayed on the screen.

The rear view monitor system will activate when the shift lever is in R. (→P. 247, 254)

The rear view monitor system will be deactivated when the shift lever is in any position other than R.

When the shift lever is shifted to the R position and any mode button (such as "SETUP") is pressed, the rear view monitor system is canceled, and the screen is switched to the mode of the button that was pressed.

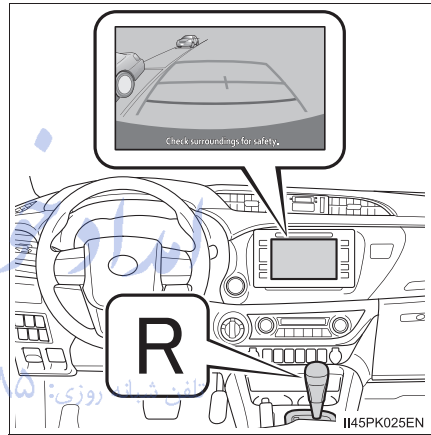

FarmaSOS.com

*: If equipped

Using the rear view monitor system

■ Screen description

▶ Vehicles without smart entry & start system

The rear view monitor system screen will be displayed if the shift lever is shifted to R while the engine switch is in the “ON” position.

▶ Vehicles with smart entry & start system

The rear view monitor system screen will be displayed if the shift lever is shifted to R while the engine switch is in IGNITION ON mode.

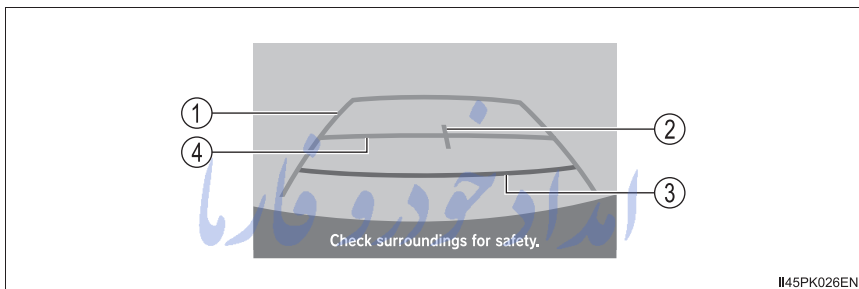

① Vehicle width guide line

The line indicates a guide path when the vehicle is being backed straight up.

The displayed width is wider than the actual vehicle width.

② Vehicle center guide line

The line indicates the estimated vehicle center on the ground.

③ Distance guide line (red)

The line shows distance behind the vehicle, a point approximately 0.5 m (1.5 ft.) from the edge of the bumper.

④ Distance guide line (blue)

The line shows distance behind the vehicle, a point approximately 1 m (3 ft.) from the edge of the bumper.

Rear view monitor system precautions

■ Area displayed on screen

The rear view monitor system displays an image of the view from the bumper of the rear area of the vehicle.

The image on the rear view monitor system screen can be adjusted. Refer to the “Navigation and multimedia system Owner’s manual”.

- The area displayed on the screen may vary according to vehicle orientation conditions.
- Objects which are close to either corner of the bumper or under the bumper cannot be displayed.
- The camera uses a special lens. The distance of the image that appears on the screen differs from the actual distance.
- Items which are located higher than the camera may not be displayed on the monitor.

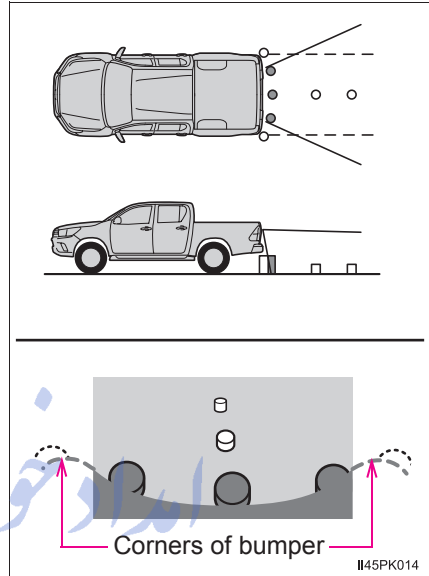

■ Rear view monitor system camera

The camera for the rear view monitor system is located on the tail-gate.

▶ Type A

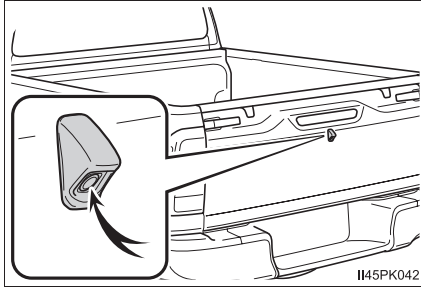

▶ Type B

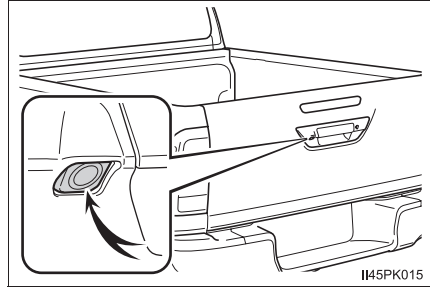

● Using the camera

If dirt or foreign matter (such as water droplets, snow, mud etc.) is adhering to the camera, it cannot transmit a clear image. In this case, flush it with a large quantity of water and wipe the camera lens clean with a soft and wet cloth.

■ Differences between the screen and the actual road

The distance guide lines and the vehicle width guide lines may not actually be parallel with the dividing lines of the parking space, even when they appear to be so. Be sure to check visually.

The distances between the vehicle width guide lines and the left and right dividing lines of the parking space may not be equal, even when they appear to be so. Be sure to check visually.

The distance guide lines give a distance guide for flat road surfaces. In any of the following situations, there is a margin of error between the fixed guide lines on the screen and the actual distance/course on the road.

- When the ground behind the vehicle slopes up sharply

The distance guide lines will appear to be closer to the vehicle than the actual distance. Because of this, objects will appear to be further away than they actually are. In the same way, there will be a margin of error between the guide lines and the actual distance/course on the road.

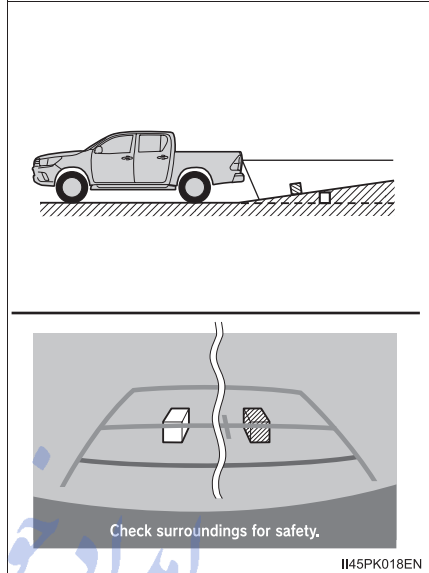

- When the ground behind the vehicle slopes down sharply

The distance guide lines will appear to be further from the vehicle than the actual distance. Because of this, objects will appear to be closer than they actually are. In the same way, there will be a margin of error between the guide lines and the actual distance/course on the road.

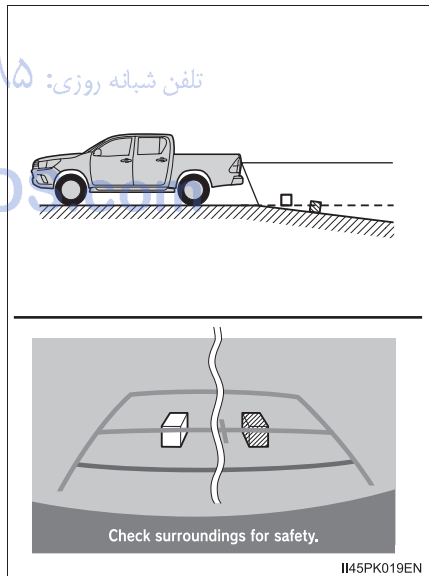

- When any part of the vehicle sags

When any part of the vehicle sags due to the number of passengers or the distribution of the load, there is a margin of error between the fixed guide lines on the screen and the actual distance/course on the road.

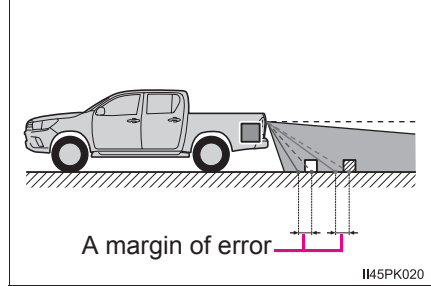

- When approaching three-dimensional objects

The distance guide lines are displayed according to flat surfaced objects (such as the road). It is not possible to determine the position of three-dimensional objects (such as vehicles) using the vehicle width guide lines and distance guide lines. When approaching a three-dimensional object that extends outward (such as the flatbed of a truck), be careful of the following.

- Vehicle width guide lines

Visually check the surroundings and the area behind the vehicle. In the case shown in the illustration, the truck appears to be outside of the vehicle width guide lines and the vehicle does not look as if it hits the truck. However, the rear body of the truck may actually cross over the vehicle width guide lines. In reality if you back up as guided by the vehicle width guide lines, the vehicle may hit the truck.

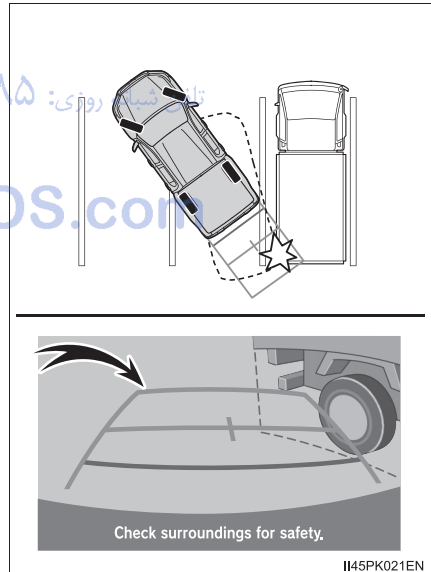

● Distance guide lines

Visually check the surroundings and the area behind the vehicle. On the screen, it appears that a truck is parking at point ②. However, in reality if you back up to point ①, you will hit the truck. On the screen, it appears that ① is closest and ③ is farthest away. However, in reality, the distance to ① and ③ is the same, and ② is further than ① and ③.

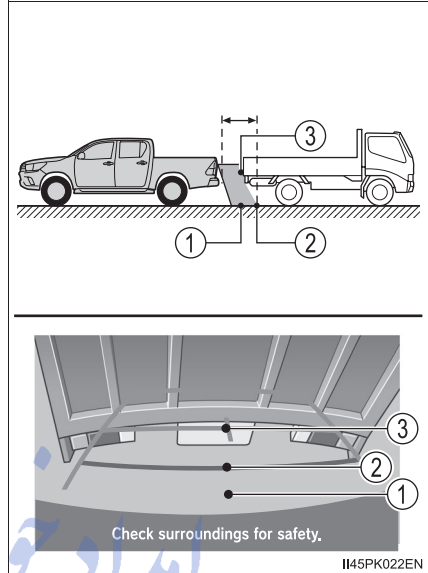

تلفن شبانه روزی: ۰۲۱-۸۸۸۶۲۰۸۵

FarmaSOS.com

Things you should know

■ If you notice any symptoms

If you notice any of the following symptoms, refer to the likely cause and the solution, and re-check.

If the symptom is not resolved by the solution, have the vehicle inspected by any authorized Toyota dealer or repairer, or another duly qualified and equipped professional.

Likely cause	Solution
<input type="checkbox"/> The image is difficult to see	
<ul style="list-style-type: none"> • The vehicle is in a dark area • The temperature around the lens is either high or low • The outside temperature is low • There are water droplets on the camera • It is raining or humid • Foreign matter (mud etc.) is adhering to the camera • There are scratches on the camera • Sunlight or headlights are shining directly into the camera • The vehicle is under fluorescent lights, sodium lights, mercury lights etc. 	<p>If this happens due to these causes, it does not indicate a malfunction. Back up while visually checking the vehicle's surroundings. (Use the monitor again once conditions have been improved.)</p> <p>The image on the rear view monitor system screen can be adjusted, refer to the "Navigation and multimedia system Owner's manual".</p>
<input type="checkbox"/> The image is blurry	
<p>Dirt or foreign matter (such as water droplets, snow, mud etc.) is adhering to the camera.</p>	<p>Flush the camera with a large quantity of water and wipe the camera lens clean with a soft and wet cloth.</p>

Likely cause	Solution
<input type="checkbox"/> The image is out of alignment	
The camera or surrounding area has received a strong impact.	Have the vehicle inspected by any authorized Toyota dealer or repairer, or another duly qualified and equipped professional.
<input type="checkbox"/> The fixed guide lines are very far out of alignment	
The camera position is out of alignment.	Have the vehicle inspected by any authorized Toyota dealer or repairer, or another duly qualified and equipped professional.
<ul style="list-style-type: none"> • The vehicle is tilted (there is a heavy load on the vehicle, tire pressure is low due to a tire puncture, etc.) • The vehicle is used on an incline. 	If this happens due to these causes, it does not indicate a malfunction. Back up while visually checking the vehicle's surroundings.

امداد خودرو فارما

تلفن شبانه روزی: ۰۲۱-۸۸۸۶۲۰۸۵

FarmaSOS.com

 **WARNING****■ When using the rear view monitor system**

The rear view monitor system is a supplemental device intended to assist the driver when backing up. When backing up, be sure to visually check all around the vehicle both directly and using the mirrors before proceeding.

Observe the following precautions to avoid an accident that could result in death or serious injuries.

- Never depend on the rear view monitor system entirely when backing up. The image and the position of the guide lines displayed on the screen may differ from the actual state. Use caution, just as you would when backing up any vehicle.
- Be sure to back up slowly, depressing the brake pedal to control vehicle speed.
- The instructions given are only guide lines. When and how much to turn the steering wheel will vary according to traffic conditions, road surface conditions, vehicle condition, etc. when parking. It is necessary to be fully aware of this before using the rear view monitor system.
- When parking, be sure to check that the parking space will accommodate your vehicle before maneuvering into it.
- Do not use the rear view monitor system in the following cases:
 - On icy or slick road surfaces, or in snow
 - When using tire chains
 - When the tailgate is not closed completely
 - On roads that are not flat or straight, such as curves or slopes.
- In low temperatures, the screen may darken or the image may become faint. The image could distort when the vehicle is moving, or you may become unable to see the image on the screen. Be sure to visually check all around the vehicle both directly and using the mirrors before proceeding.
- If the tire sizes are changed, the position of the fixed guide lines displayed on the screen may change.
- The camera uses a special lens. The distances between objects and pedestrians that appear in the image displayed on the screen will differ from the actual distances.



NOTICE

How to use the camera

- The rear view monitor system may not operate properly in the following cases.
 - If the back of the vehicle is hit, the position and mounting angle of the camera may change.
 - As the camera has a water proof construction, do not detach, disassemble or modify it. This may cause incorrect operation.
 - When cleaning the camera lens, flush the camera with a large quantity of water and wipe it with a soft and wet cloth. Strongly rubbing the camera lens may cause the camera lens to be scratched and unable to transmit a clear image.
 - Do not allow organic solvent, car wax, window cleaner or glass coat to adhere to the camera. If this happens, wipe it off as soon as possible.
 - If the temperature changes rapidly, such as when hot water is poured on the vehicle in cold weather, the system may not operate normally.
 - When washing the vehicle, do not apply intensive bursts of water to the camera or camera area. Doing so may result in the camera malfunctioning.
 - When the camera is used under fluorescent lights, sodium light or mercury light etc., the lights and the illuminated areas may appear to flicker.
- Do not expose the camera to strong impact as this could cause a malfunction. If this happens, have the vehicle inspected by any authorized Toyota dealer or repairer, or another duly qualified and equipped professional as soon as possible.

Four-wheel drive system*

Use the front-wheel drive control switch to select the following transfer modes.

- ① H2 (high speed position, two-wheel drive)

Use this for normal driving on dry hard-surfaced roads. This position gives greater economy, quietest ride and least wear.

- ② H4 (high speed position, four-wheel drive)

Use this for driving only on tracks that permit the tires slide, like off-road, icy or snow-covered roads. This position provides greater traction than two-wheel drive.

The four-wheel drive indicator light comes on

- ③ L4 (low speed position, four-wheel drive)

Use this for maximum power and traction. Use L4 for climbing or descending steep hills, off-road driving, and hard pulling in sand, mud or deep snow.

The four-wheel drive and low speed four-wheel drive indicator lights come on

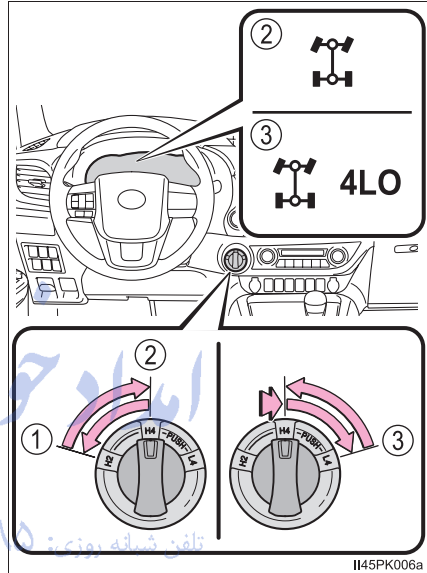

A.D.D. (automatic disconnecting differential) (if equipped)

The A.D.D. can be engaged or disengaged by the shifting operations described in the following shifting procedures.

*: If equipped

Shifting between H2 and H4

■ Shifting from H2 to H4

- 1 Reduce the vehicle speed to less than 100 km/h (62 mph).

The transfer mode cannot be switched if the vehicle speed is more than 100 km/h (62 mph).

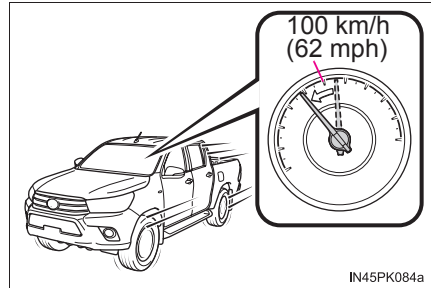

- 2 Turn the front-wheel drive control switch to H4.

The four-wheel drive indicator light flashes while switching.

If turning the front-wheel drive control switch when the vehicle speed is more than 100 km/h (62 mph), the four-wheel drive indicator light flashes and a buzzer sounds.

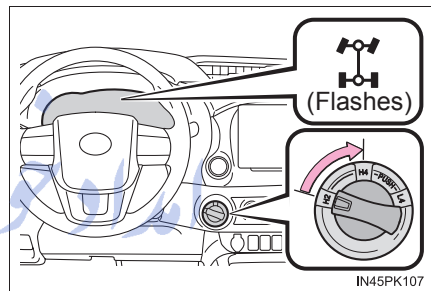

Reduce the vehicle speed to less than 100 km/h (62 mph), or return the front-wheel drive control switch to H2 and try step 1 again.

- 3 Check that the four-wheel drive indicator light comes on.

The four-wheel drive indicator light comes on when switching the transfer mode is completed.

If the four-wheel drive indicator light does not stop flashing after turning the front-wheel drive control switch from H2 to H4, perform any of the followings while driving straight.

- Accelerating
- Decelerating
- Driving in reverse

The four-wheel drive indicator light may not stop flashing if the front-wheel drive control switch is turned from H2 to H4 while the vehicle is stopped. In this case, perform any of the followings.

- Driving forward
- Driving in reverse

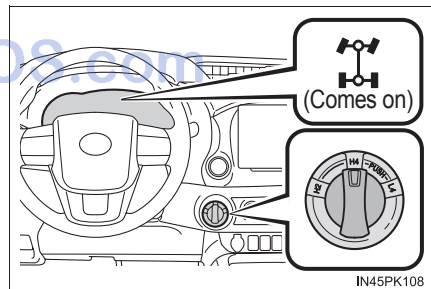

■ Shifting from H4 to H2

- 1 Turn the front-wheel drive control switch to H2.

The four-wheel drive indicator light flashes while switching.

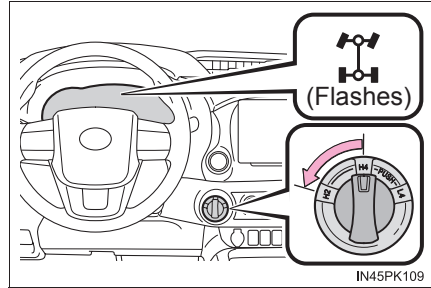

- 2 Check that the four-wheel drive indicator light goes off.

The four-wheel drive indicator light goes off when switching the transfer mode is completed.

If the four-wheel drive indicator light does not stop flashing after turning the front-wheel drive control switch from H4 to H2, perform the followings while driving straight.

- Accelerating
- Decelerating
- Driving in reverse

If the four-wheel drive indicator light is still flashing, perform the operations above while turning the steering wheel left and right.

Impact may be felt through the vehicle body and steering. However, this does not indicate a malfunction.

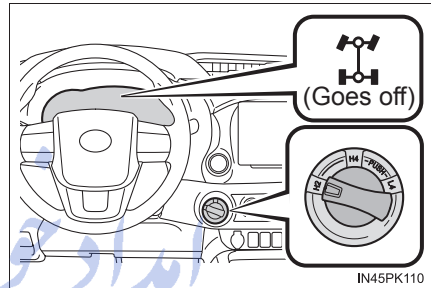

Shifting between H4 and L4 (automatic transmission)

■ Shifting from H4 to L4

- 1 Stop the vehicle.

The transfer mode cannot be switched if the vehicle is moving.

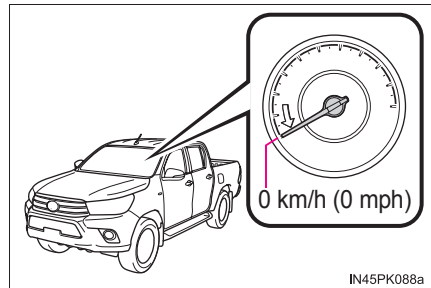

IN45PK088a

- 2 Shift the shift lever to N.

Keep the shift lever in N until switching the transfer mode is completed (indicator on).

The transfer mode cannot be switched if the shift lever is in other than N.

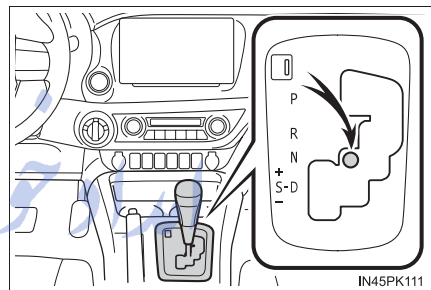

IN45PK111

- 3 Push and turn the front-wheel drive control switch to L4.

The low speed four-wheel drive indicator light flashes while switching.

If turning the front-wheel drive control switch without following steps 1 and 2, the low speed four-wheel drive indicator light flashes and a buzzer sounds. Return the front-wheel drive control switch to H4 and try steps 1 and 2 again.

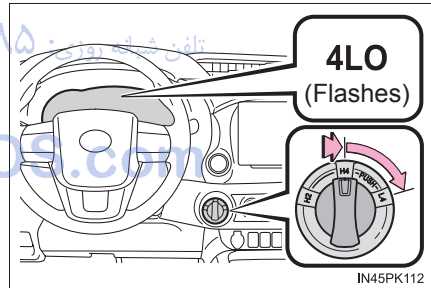

IN45PK112

If the shift lever is shifted to other than N while the low speed four-wheel drive indicator light is flashing, gear noise may be caused. Immediately shift the shift lever to N and wait until switching the transfer mode is completed.

- 4 Check that the low speed four-wheel drive indicator light comes on.

The low speed four-wheel drive indicator light comes on when switching the transfer mode is completed.

Shift the shift lever from N to D or R to drive the vehicle.

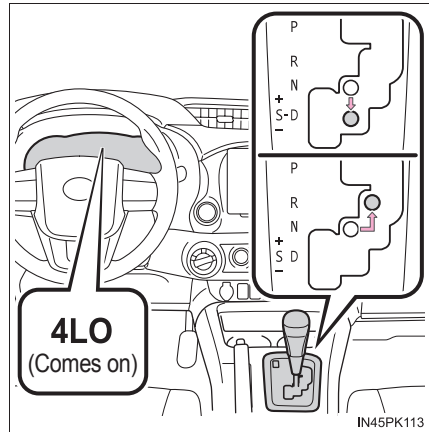

■ Shifting from L4 to H4

- 1 Stop the vehicle.

The transfer mode cannot be switched if the vehicle is moving.

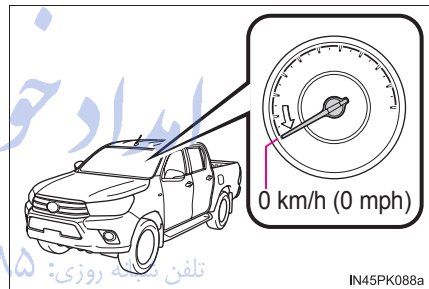

- 2 Shift the shift lever to N.

Keep the shift lever in N until switching the transfer mode is completed (indicator off).

The transfer mode cannot be switched if the shift lever is in other than N.

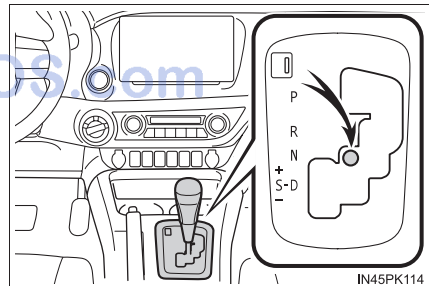

- 3 Turn the front-wheel drive control switch to H4.

The low speed four-wheel drive indicator light flashes while switching.

If turning the front-wheel drive control switch without following steps 1 and 2, the low speed four-wheel drive indicator light flashes and a buzzer sounds. Return the front-wheel drive control switch to L4 and try steps 1 and 2 again.

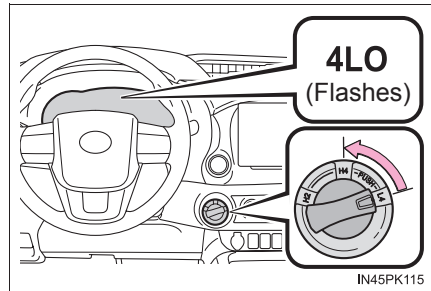

If the shift lever is shifted to other than N while the low speed four-wheel drive indicator light is flashing, gear noise may be caused. Immediately shift the shift lever to N and wait until switching the transfer mode is completed.

- 4 Check that the low speed four-wheel drive indicator light goes off.

The low speed four-wheel drive indicator light goes off when switching the transfer mode is completed.

Shift the shift lever from N to D or R to drive the vehicle.

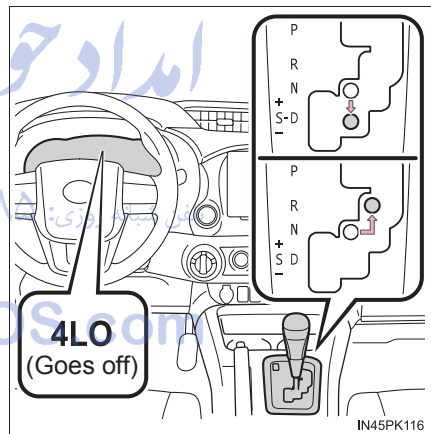

 NOTICE

■ **Shifting between H4 and L4**

Do not shift the shift lever to other than N or depress the accelerator pedal while the low speed four-wheel drive indicator light is flashing. Failure to do so may cause gear noise and result in a malfunction.

Shifting between H4 and L4 (manual transmission)

■ Shifting from H4 to L4

- 1 Stop the vehicle.

The transfer mode cannot be switched if the vehicle is moving.

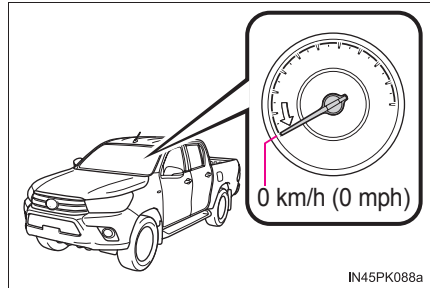

- 2 Firmly depress the clutch pedal.

Keep depressing the clutch pedal until switching the transfer mode is completed (indicator on).

The transfer mode cannot be switched if the clutch pedal is not fully depressed.

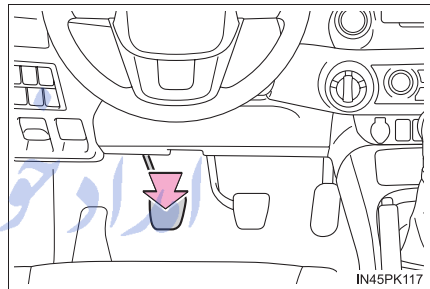

- 3 Push and turn the front-wheel drive control switch to L4.

The low speed four-wheel drive indicator light flashes while switching.

If turning the front-wheel drive control switch without following steps 1 and 2, the low speed four-wheel drive indicator light flashes and a buzzer sounds. Return the front-wheel drive control switch to H4 and try steps 1 and 2 again.

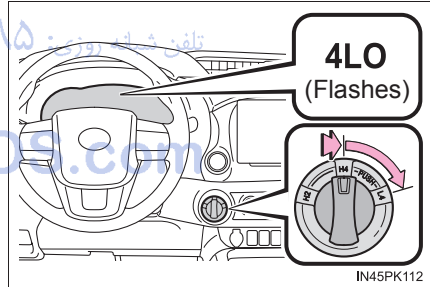

If the clutch pedal is released while the low speed four-wheel drive indicator light is flashing, gear noise may be caused. Immediately depress the clutch pedal firmly and wait until switching the transfer mode is completed.

- 4 Check that the low speed four-wheel drive indicator light comes on.

The low speed four-wheel drive indicator light comes on when switching the transfer mode is completed.

Release the clutch pedal to drive the vehicle.

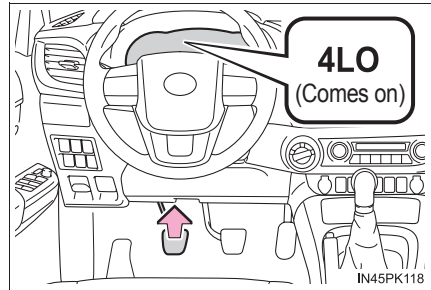

■ Shifting from L4 to H4

- 1 Stop the vehicle.

The transfer mode cannot be switched if the vehicle is moving.

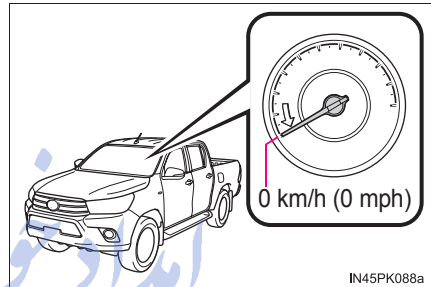

- 2 Firmly depress the clutch pedal.

Keep depressing the clutch pedal until switching the transfer mode is completed (indicator off).

The transfer mode cannot be switched if the clutch pedal is not fully depressed.

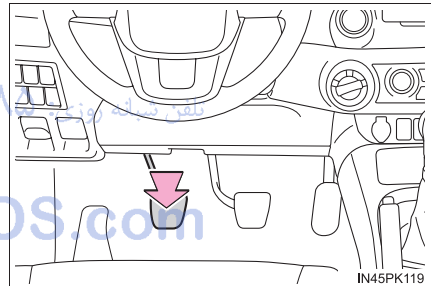

- 3 Turn the front-wheel drive control switch to H4.

The low speed four-wheel drive indicator light flashes while switching.

If turning the front-wheel drive control switch without following steps 1 and 2, the low speed four-wheel drive indicator light flashes and a buzzer sounds. Return the front-wheel drive control switch to L4 and try steps 1 and 2 again.

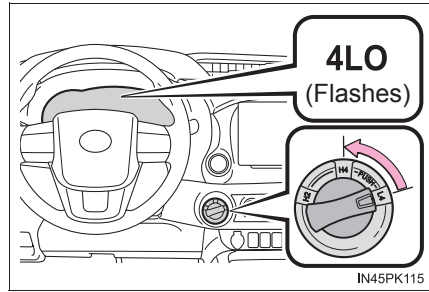

If the clutch pedal is released while the low speed four-wheel drive indicator light is flashing, gear noise may be caused. Immediately depress the clutch pedal firmly and wait until switching the transfer mode is completed.

- 4 Check that the low speed four-wheel drive indicator light goes off.

The low speed four-wheel drive indicator light goes off when switching the transfer mode is completed.

Release the clutch pedal to drive the vehicle.

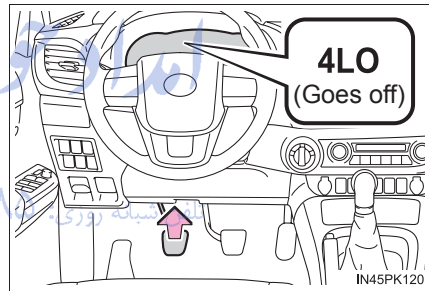

NOTICE

FarmaSOS.com

■ Shifting between H4 and L4

Do not release the clutch pedal or depress the accelerator pedal while the low speed four-wheel drive indicator light is flashing. Failure to do so may cause gear noise and result in a malfunction.

■ Four-wheel drive usage frequency (vehicles with A.D.D.)

You should drive in four-wheel drive for at least 16 km (10 miles) each month. This will assure that the front drive components are lubricated.

■ Shifting between H2 and H4

If you have trouble shifting in cold weather, reduce your speed or stop the vehicle and reshift.

■ Shifting to L4 (vehicles with VSC)

VSC is automatically turned off.

■ When driving on dry paved surface roads and expressway

Use H2 position. If the vehicle is driven in H4 or L4 position for a long time, a warning buzzer sounds, and the four-wheel drive indicator light flashes rapidly or a warning message is shown on the multi-information display. If the warning message is shown on the multi-information display, follow the message.

■ If “DIFFERENTIAL OIL TEMP HIGH SHIFT TO 2WD MODE COOLING TIME REQUIRED”/“Differential oil temp high Shift to 2WD mode Cooling time required” is shown on the multi-information display (vehicles with multi-information display)

The differential oil temperature is too high.

Turn the front-wheel drive control switch to H2, and wait until the warning message goes off.



WARNING

■ While driving

- Never turn the front-wheel drive control switch from H2 to H4 if the wheels are slipping. Stop the slipping or spinning before shifting.
- For normal driving on dry and hard surface roads, use H2 position. Driving on dry and hard surface roads in H4 or L4 position may cause drive component oil leakage, seizure, or other problems resulting in an accident. Further, it may cause tire wear and increased fuel consumption.
- Avoid turning suddenly in H4 or L4 position. If you do turn suddenly, the difference in turning speeds between the front and rear wheels may have a similar effect to braking, thus making driving difficult.

Rear differential lock system*

The rear differential lock system is provided for use only when wheel spinning occurs in a ditch or on a slippery or ragged surface.

This differential lock system is effective in case one of the rear wheels is spinning.

Press the rear differential lock switch to lock the rear differential.

The rear differential lock indicator comes on.

To unlock the rear differential, push the switch again.

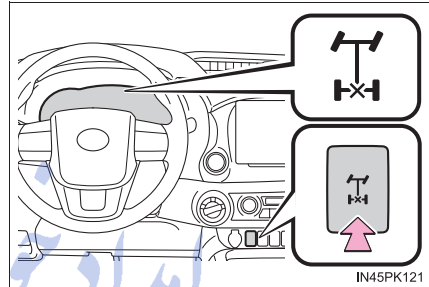

تلفن شبانه روزی: ۰۲۱-۸۸۸۶۲۰۸۵

FarmaSOS.com

Using the rear differential lock system

- 1 4WD models only: Before using the rear differential lock system, turn the front-wheel drive control switch to L4 and try to move the vehicle. (→P. 332, 335)

If this is not sufficient, use the rear differential lock system as well.

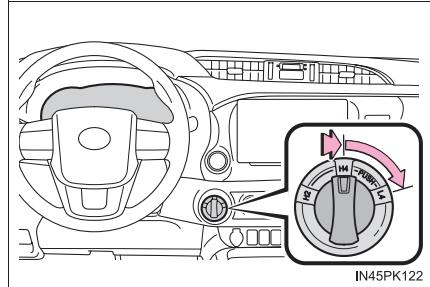

- 2 Reduce the vehicle speed to less than 8 km/h (5 mph).

Make sure that the wheels are not spinning.

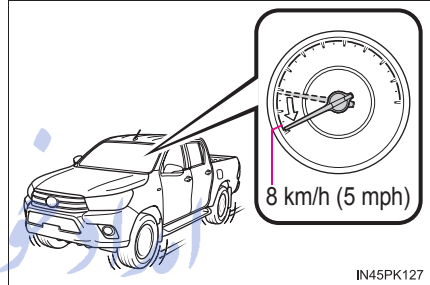

- 3 Press the rear differential lock switch.

The rear differential lock indicator flashes while the rear differential is being locked.

If pressing the rear differential lock switch without following steps 1 and 2, the rear differential lock indicator flashes three times and a buzzer sounds three times, and the rear differential cannot be locked. Try steps 1 and 2 again.

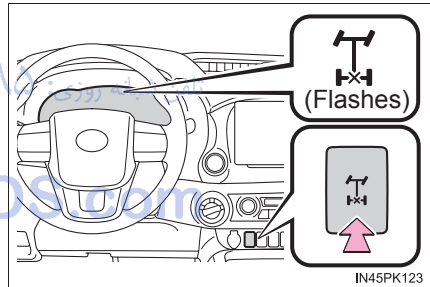

- 4 Gently depress the accelerator pedal.

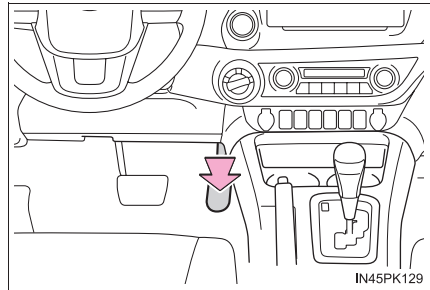

- 5 Check that the rear differential lock indicator comes on.

The rear differential lock indicator comes on when locking the rear differential is completed.

If the rear differential lock indicator does not stop flashing after pressing the rear differential lock switch, perform any of the followings while turning the steering wheel left and right.

- Accelerating
- Decelerating

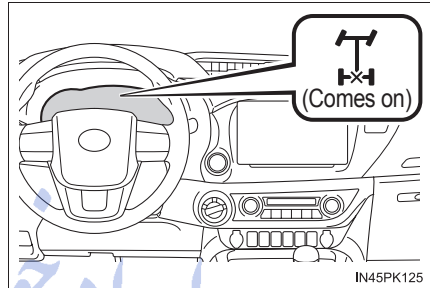

Unlock the rear differential as soon as the vehicle moves. To unlock the rear differential, push the switch again.

FarmaSOS.com

■ Locking the rear differential

The following systems do not operate when the rear differential is locked. It is normal operation for the ABS warning light, VSC OFF indicator (if equipped) and "TRC OFF" indicator (if equipped) to be on or for "TRC TURNED OFF"/"TRC turned off" to be displayed on the multi-information display (if equipped) at this time.

- ABS
- Brake assist (if equipped)
- VSC (if equipped)
- TRC/A-TRC (if equipped)
- Trailer Sway Control (if equipped)
- Hill-start assist control (if equipped)
- Downhill assist control (if equipped)

■ For easy unlocking

Slightly turn the steering wheel in either direction while the vehicle is in motion.

■ Automatic system cancelation of the rear differential lock system

The rear differential lock is also unlocked in any of the following situations:

- The front-wheel drive control switch is turned to H2 or H4 (4WD models)
- The engine switch is turned to the "ACC" or "LOCK" position (vehicles without smart entry & start system) or ACCESSORY or off (vehicles with smart entry & start system)

■ After unlocking the rear differential

Check that the indicator goes off.



WARNING

■ To avoid an accident

Failure to observe the following precautions may result in an accident.

- Do not use the rear differential lock system except when wheel spinning occurs in a ditch or on a slippery or rugged surface. Large steering effort and careful cornering control will be required.
- Do not lock the rear differential until the wheels have stopped spinning. Otherwise, the vehicle may move in an unexpected direction when the differential lock is engaged, resulting in an accident. This may also lead to possible damage to rear differential lock component parts.
- Do not drive over 8 km/h (5 mph) when the differential is locked.
- Do not keep driving with the rear differential lock switch on.

Stop & Start system (Smart Stop)*

The Stop & Start system stops and restarts the engine according to the brake pedal operation (automatic transmission) or clutch pedal operation (manual transmission) for stopping and starting the vehicle.

Stop & Start system operation

■ Stopping the engine

- ▶ Vehicles with automatic transmission

While driving in D or S, depress the brake pedal, and stop the vehicle.

The Stop & Start indicator will come on.

- ▶ Vehicles with manual transmission

Stop the vehicle With the clutch pedal fully depressed, shift the shift lever to N, and release the clutch pedal.

The Stop & Start indicator will come on.

■ Restarting the engine

- ▶ Vehicles with automatic transmission

Release the brake pedal.

The Stop & Start indicator will go off.

- ▶ Vehicles with manual transmission

Check that the shift lever is in N and depress the clutch pedal.

The Stop & Start indicator will go off.

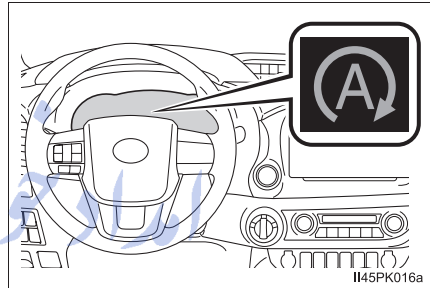

Disabling the Stop & Start system

Press the Stop & Start cancel switch to disable the Stop & Start system.

The Stop & Start cancel indicator will come on.

Press the switch again to re-enable the Stop & Start system.

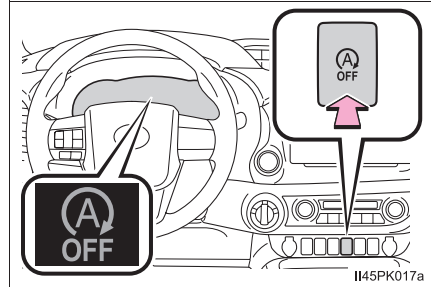

■ Automatic reactivation of the Stop & Start system

Even if the Stop & Start system is disabled by the Stop & Start cancel switch, it will be automatically re-enabled once the engine switch is turned to the "LOCK" position (vehicles without smart entry & start system) or off (vehicles with smart entry & start system), and then the engine is started.

■ If the Stop & Start cancel switch is pressed while the vehicle is stopped

- When the engine is stopped by the Stop & Start system, pressing the Stop & Start cancel switch will restart the engine.
From the next time the vehicle is stopped (after Stop & Start system has been turned off), the engine will not be stopped.
- With the Stop & Start system disabled, pressing the Stop & Start cancel switch will re-enable the system but not stop the engine.
From the next time the vehicle is stopped (after Stop & Start system has been turned on), the engine will be stopped.

Hill-start assist control

After the engine is stopped by the Stop & Start system when the vehicle is on an incline, brake force is temporarily maintained to prevent rolling backwards until the engine is restarted and drive force is generated. When drive force is generated, the maintained brake force is automatically canceled.

- This system operates on flat surfaces as well as steep grades.
- Sound may be generated by the brakes, but this is not a malfunction.
- The brake pedal response may change and vibration may occur, but these are not malfunctions.

Operating conditions

- The Stop & Start system is operational when all of the following conditions are met:
 - Vehicles with automatic transmission: The brake pedal is being depressed firmly
 - Vehicles with manual transmission: The clutch pedal is not being depressed.
 - The engine is adequately warmed up.
 - The outside temperature is -5°C (23°F) or higher
 - Vehicles with automatic transmission: The shift lever is in D or S, or P after driving in D or S.
 - Vehicles with manual transmission: The shift lever is in N.
 - Vehicles with automatic air conditioning system:  is off.
 - The hood is closed. (→P. 347)
 - The driver's seat belt is fastened.
 - The driver's door is closed.
 - The accelerator pedal is not being depressed.
- In the following circumstances, the engine may not be stopped by the Stop & Start system. This is not a malfunction of the Stop & Start system.
 - The air conditioning system is being used when the ambient temperature is high or low.
 - The battery is not sufficiently charged, or is undergoing a periodic recharge.
 - The brake booster vacuum is low.
 - The vehicle is stopped on a steep hill.

- When the steering wheel is being operated
 - Due to traffic or other circumstances the vehicle is stopped repeatedly, resulting in the amount of time the engine is stopped by the Stop & Start system to become excessively high.
 - At high altitude.
 - Engine coolant temperature or transmission fluid temperature is too low or too high.
 - The battery fluid temperature is excessively high or low.
 - After the battery terminals have been disconnected and reconnected.
 - For a while after a battery replacement.
 - When the front-wheel drive control switch is in the L4 position or the rear differential is locked.
- In the following circumstances, the engine will automatically restart when the engine is stopped by the Stop & Start system.
- The air conditioning system is turned on.
 - Vehicles with automatic air conditioning system:  is turned on.
 - When the steering wheel is being operated.
 - Vehicles with automatic transmission: The shift lever is in any position other than D, S or P.
 - Vehicles with manual transmission: The shift lever is in any position other than N
 - The driver's seat belt is unfastened.
 - The driver's door is opened.
 - The accelerator pedal is depressed.
 - The Stop & Start cancel switch is pressed.
 - The vehicle starts to roll on an incline.

In order to have the engine stopped by the Stop & Start system again, drive the vehicle once.

Vehicles with automatic transmission: The engine may be stopped by Stop & Start system automatically without driving the vehicle if the idling stop time is set to "Long". (→P. 348)

- In the following circumstances, the engine may automatically restart when the engine is stopped by the Stop & Start system.
- The brake pedal is pumped or strongly depressed.
 - The air conditioning system is being used.
 - The battery is not sufficiently charged.

In order to have the engine stopped by the Stop & Start system again, drive the vehicle once.

Vehicles with automatic transmission: The engine may be stopped by Stop & Start system automatically without driving the vehicle if the idling stop time is set to "Long". (→P. 348)

■ Hood

- If the hood is opened while the engine is stopped by the Stop & Start system, the engine may not be restarted by the Stop & Start system or by the automatic engine start function. In this case, shift the shift lever to P (vehicles with automatic transmission) or N (vehicles with manual transmission) and restart the engine with the engine switch operation. (→P. 236, 239)
- Even if the hood is closed after the engine is started with the hood open, the Stop & Start system does not operate. Close the hood, turn the engine switch to the “LOCK” position (vehicles without smart entry & start system) or off (vehicles with smart entry & start system), wait 30 seconds or more, and then start the engine.

■ Steering wheel operation

When the engine is stopped by the Stop & Start system, the steering wheel may become heavier than when driving.

■ When to use the Stop & Start system

- Use the Stop & Start system when stopping the vehicle temporarily at red lights, intersections, etc. When stopping the vehicle for a longer period of time, turn off the engine completely.
- When the system cannot operate, is canceled, or is malfunctioning, warning messages and the warning buzzer are used to inform the driver. (→P. 349)
- Even if an attempt is made to start the engine during an engine stop, the engine does not automatically restart. Start the engine by shifting the shift lever to P (vehicles with automatic transmission) or N (vehicles with manual transmission) and performing a normal engine start operation.
- When the engine restarts after having been stopped by the Stop & Start system, the power outlet may be temporarily unusable, but this is not a malfunction.
- Installation and removal of electrical components and wireless devices may affect the Stop & Start system, contact any authorized Toyota dealer or repairer, or another duly qualified and equipped professional.

■ If the windshield is fogged up while the engine is stopped by the Stop & Start system

▶ Vehicles with manual air conditioning system:

Restart the engine by pressing the Stop & Start cancel switch, and then set the air outlet selection dial to . (→P. 449)

▶ Vehicles with automatic air conditioning system:

Turn the windshield defogger on. (The engine will start due to the automatic engine start function.) (→P. 458)

If the windshield fogs up frequently, press the Stop & Start cancel switch to deactivate the system.

■ Air conditioning system while the engine is stopped by the Stop & Start system

While the engine is stopped by the Stop & Start system, the air conditioning system (cooling, heating and dehumidifying functions) is cancelled and it only blows air or stops blowing air. In order to prevent the air conditioning system from being cancelled, deactivate the Stop & Start system by pressing the Stop & Start cancel switch.

■ If an odor comes from the air conditioning system while the engine is stopped by the Stop & Start system

Vehicles with manual air conditioning system:





If the idling stop time is set to “Long”, change the setting to “Normal”. If an odor occurs even when “Normal” is selected, press the Stop & Start cancel switch to deactivate the Stop & Start system.

Vehicles with automatic air conditioning system:

Press the Stop & Start cancel switch to deactivate the Stop & Start system.

■ Switching the idling stop time with the air conditioning system on

When the air conditioning system is on, the Stop & Start system idling stop time can be adjusted by performing the following operation.

- 1 Use the meter control switches to select  while the vehicle is stopped and press , and select  and press .
- 2 Select “Normal” or “Long”, and then press .

■ The Stop & Start system protection feature

- When an excessively loud sound is being projected by the audio system, the audio system may be automatically cut off in order to reduce battery consumption. If it occurs, turn the engine switch to the “LOCK” position (vehicles without smart entry & start system) or off (vehicles with smart entry & start system), wait for 3 seconds or longer and then turn it to the “ACC” or “ON” position (vehicles without smart entry & start system), or ACCESSORY mode or IGNITION ON mode (vehicles with smart entry & start system) to re-enable the audio system.
- The audio system may not be activated when the battery terminals are disconnected and then reconnected. If it occurs, turn the engine switch to the “LOCK” position (vehicles without smart entry & start system) or off (vehicles with smart entry & start system), and then repeat the following operation twice to activate the audio system normally.
 - Turn the engine switch to the “ON” position (vehicles without smart entry & start system), or IGNITION ON mode (vehicles with smart entry & start system), and then to the “LOCK” position (vehicles without smart entry & start system) or off (vehicles with smart entry & start system).

■ Replacing battery

→P. 610

■ Displaying the Stop & Start system status

Operation status of the Stop & Start system can be displayed on the (Drive information) screen of multi-information display. (→P. 139)



Smart Stop	Displays the current engine stop time. Also, the engine stop time when the air conditioning system is on can be adjusted using the meter control switches. (→P. 348)
After Start	Displays the cumulative time that the engine is stopped by the Stop & Start system from when the engine is started until the engine is stopped.
After Reset	Displays the cumulative time that the engine is stopped by the Stop & Start system from the previous reset until the system is reset again.

The display of “After Reset” can be reset.





- To reset the display, press of the meter control switches, press “<” or “>” to select “Reset”, and then press and hold .
- To stop the reset procedure, press .

■ Multi-information display messages







When the engine cannot be stopped by the Stop & Start system, and when the engine automatically restarts while stopped by the Stop & Start system, the following messages are displayed on the multi-information display.

- When the engine cannot be stopped by the Stop & Start system

Message	Details/Actions
“Depress brake firmly to activate”	The brake pedal is not depressed enough. → Operates when the brake pedal is depressed further after stopping the vehicle.
“For climate control”	Vehicles with automatic air conditioning system: <ul style="list-style-type: none"> • The air conditioning system is being used when the ambient temperature is high or low. → Readily operates when the difference between the set temperature and cabin temperature is small. <ul style="list-style-type: none"> • is pressed.

Message	Details/Actions
 <p>“Battery charging”</p>	<ul style="list-style-type: none"> • The battery charge amount may be low. → Engine stop is temporarily prohibited to prioritize charging of the battery, but if the engine is operated for a short while, engine stop is allowed. • A refresh charge may be occurring (Examples: A short time after replacing the battery, removing battery terminals, etc.) → After a refresh charge of approximately 5 to 40 minutes completes, the system can be operated. • The engine may have been started with the hood opened. → Close the hood, turn the engine switch to the “LOCK” position (vehicles without smart entry & start system) or off (vehicles with smart entry & start system), wait 30 seconds or more, and then start the engine. • The battery may be cold. → Operating the engine for a short while allows the system to recover due to the temperature increase in the engine compartment. • The battery may be extremely hot. → If the engine is stopped and the engine compartment is allowed to cool sufficiently, the system recovers.
 <p>“For brake system”</p>	<ul style="list-style-type: none"> • The brake booster load decreased. • The vehicle is operated at a high elevation. → When a predetermined load is generated by the brake booster, the system recovers.
 <p>“Driver seat belt unbuckled”</p>	<p>The driver seat belt is not fastened.</p>
 <p>“Non-dedicated battery”</p>	<p>A non-dedicated battery for the Stop & Start system may have been installed. → The Stop & Start system does not operate. Have the vehicle inspected by any authorized Toyota dealer or repairer, or another duly qualified and equipped professional.</p>

- When the engine automatically restarts while stopped by the Stop & Start system

Message	Details/Actions
 “For climate control”	Vehicles with automatic air conditioning system: <ul style="list-style-type: none"> • The air conditioning system is turned on or the air conditioning is being used. •  is turned on.
 “For brake system”	The brake pedal is strongly depressed further or pumped. → When a predetermined load is generated from the brake booster by driving the vehicle, the system recovers.
 “Battery charging”	The battery charge amount may be low. → The engine is restarted to prioritize battery charging. Operating the engine for a short while allows the system to recover.
 “Steering wheel turned”	The steering wheel is turned.
 “Driver seat belt unbuckled”	The driver seat belt is not fastened.

- If “**Stop & Start system malfunction Visit your dealer**” is shown on the multi-information display (if equipped)

The system may be malfunctioning. Have the vehicle inspected by any authorized Toyota dealer or repairer, or another duly qualified and equipped professional.

- If the **Stop & Start cancel indicator continues to flash**

The system may be malfunctioning. Have the vehicle inspected by any authorized Toyota dealer or repairer, or another duly qualified and equipped professional.

 **WARNING**
■ When the Stop & Start system is operating

- Keep the shift lever in N (manual transmission), depress the brake pedal or apply the parking brake when necessary while the engine is stopped due to the Stop & Start system (while the Stop & Start indicator is on). Unexpected accidents may occur due to the automatic engine start function.
- Do not allow anyone to leave the vehicle while the engine is stopped due to the Stop & Start system (while the Stop & Start indicator is on). Unexpected accidents may occur due to the automatic engine start function.
- Ensure that the engine is not stopped by the Stop & Start system while the vehicle is in a poorly ventilated area. The engine may restart due to the automatic engine start function, causing exhaust gases to collect and enter the vehicle and resulting in death or a serious health hazard.

■ Off-road driving precaution

When driving off-road, such as driving through water, press the Stop & Start cancel switch to disable the Stop & Start system. Failure to do so may cause the engine to be unable to restart.

 **NOTICE**
■ To ensure the system operates correctly تلفن شبانه روزی ۰۲۱-۸۸۶۲۰۸۸

If any one of the following situations occurs, the Stop & Start system may not operate correctly. Have the vehicle inspected by any authorized Toyota dealer or repairer, or another duly qualified and equipped professional.

- While the driver's seat belt is fastened, the driver's and front passenger's seat belt reminder light flashes.
- Even when the driver's seat belt is not fastened, the driver's and front passenger's seat belt reminder light remains off.
- Even when the driver's door is closed, the symbol indicating the driver's door is open is shown on the multi-information display, or the personal/interior lights come on when the personal/interior light main switch or interior light switch (if equipped) is in the door position.
- Even when the driver's door is opened, the symbol indicating the driver's door is open is not shown on the multi-information display, or the personal/interior lights do not come on when the personal/interior light main switch or interior light switch (if equipped) is in the door position.

Driving assist systems

To help enhance driving safety and performance, the following systems operate automatically in response to various driving situations. Be aware, however, that these systems are supplementary and should not be relied upon too heavily when operating the vehicle.

◆ ABS (Anti-lock Brake System)

Helps to prevent wheel lock when the brakes are applied suddenly, or if the brakes are applied while driving on a slippery road surface

◆ Brake assist (if equipped)

Generates an increased level of braking force after the brake pedal is depressed when the system detects a panic stop situation

◆ VSC (Vehicle Stability Control) (if equipped)

Helps the driver to control skidding when swerving suddenly or turning on slippery road surfaces

◆ TRC (Traction Control) for Pre Runner and H2 position on 4WD models (if equipped)

Helps to maintain drive power and prevent the drive wheels from spinning when starting the vehicle or accelerating on slippery roads

◆ A-TRC (Active Traction Control) for H4 and L4 position on 4WD models (if equipped)

Helps to maintain drive power and prevent the four wheels from spinning when starting the vehicle or accelerating on slippery roads

◆ Hill-start assist control (if equipped)

Helps to prevent the vehicle from rolling backward when starting on an incline or slippery slope

◆ PCS (Pre-Crash Safety system) (if equipped)

→P. 287

◆ Emergency brake signal (if equipped)

When the brakes are applied suddenly, the emergency flashers automatically flash to alert the vehicle behind.

◆ Trailer Sway Control (if equipped)

Helps the driver to control trailer sway by selectively applying brake pressure for individual wheels and reducing engine torque when trailer sway is detected.

Trailer Sway Control is part of the VSC system and will not operate if VSC turned off or experiences a malfunction.

When the TRC/A-TRC/VSC/Trailer Sway Control systems are operating

The slip indicator will flash while the TRC/A-TRC/VSC/Trailer Sway Control systems are operating.

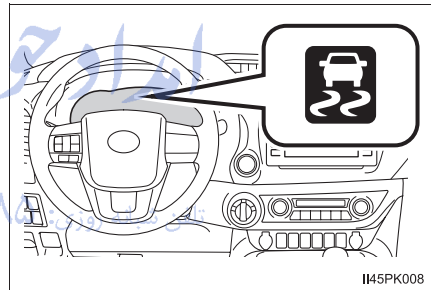

Disabling the TRC/A-TRC systems

If the vehicle gets stuck in fresh snow or mud, the TRC/A-TRC systems may reduce power from the engine to the wheels. Pressing  to turn the system off may make it easier for you to rock the vehicle in order to free it.

► Vehicles without multi-information display

To turn the TRC/A-TRC systems off, quickly press and release



The “TRC OFF” indicator light will come on.

Press  again to turn the system back on.

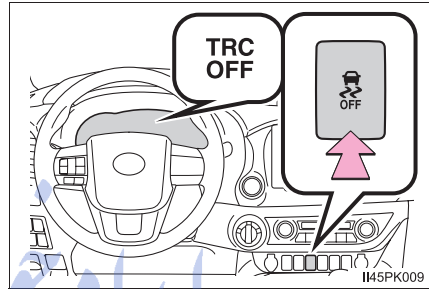

► Vehicles with multi-information display

To turn the TRC/A-TRC systems off, quickly press and release



The “TRC TURNED OFF”/“TRC turned off” will be shown on the multi-information display.

Press  again to turn the system back on.

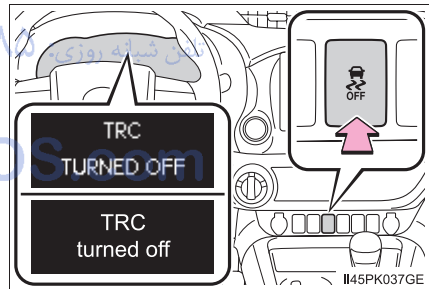

■ Turning off TRC, A-TRC, VSC and Trailer Sway Control systems

▶ Vehicles without multi-information display

To turn the TRC, A-TRC, VSC and Trailer Sway Control systems off, press

and hold  for more than 3 seconds while the vehicle is stopped.

The “TRC OFF” indicator light and VSC OFF indicator light will come on.*

Press  again to turn the system back on.

▶ Vehicles with multi-information display

To turn the TRC, A-TRC, VSC and Trailer Sway Control systems off, press

and hold  for more than 3 seconds while the vehicle is stopped.

The VSC OFF indicator light will come on and the “TRC TURNED OFF”/“TRC turned off” will be shown on the multi-information display.*

Press  again to turn the system back on.

*: On vehicles with pre-crash safety system, pre-crash brake assist and pre-crash braking will also be disabled. The PCS warning light will come on and the message will be shown on the multi-information display. (→P. 356)

■ If “TRC OFF” indicator light comes on or “TRC TURNED OFF”/“TRC turned off” is shown on the multi-information display even if  has not been pressed

TRC, A-TRC and downhill assist control cannot be operated. Contact any authorized Toyota dealer or repairer, or another duly qualified and equipped professional.

■ If “VSC TURNED OFF PRE-CRASH BRAKE SYSTEM UNAVAILABLE”/“VSC Turned Off Pre-Crash Brake System Unavailable” is shown on the multi-information display

The pre-crash brake assist and pre-crash braking functions are stopped since VSC was turned off. To activate the functions, turn VSC on.

■ Sounds and vibrations caused by the ABS, brake assist, VSC, Trailer Sway Control, TRC, A-TRC and the hill-start assist control systems

- A sound may be heard from the engine compartment when the brake pedal is depressed repeatedly, when the engine is started or just after the vehicle begins to move. This sound does not indicate that a malfunction has occurred in any of these systems.
- Any of the following conditions may occur when the above systems are operating. None of these indicates that a malfunction has occurred.
 - Vibrations may be felt through the vehicle body and steering.
 - A motor sound may be heard after the vehicle comes to a stop.
 - The brake pedal may pulsate slightly after the ABS is activated.
 - The brake pedal may move down slightly after the ABS is activated.

■ Automatic reactivation of TRC, A-TRC, VSC and Trailer Sway Control systems

After turning the TRC, A-TRC, VSC and Trailer Sway Control systems off, the systems will be automatically re-enabled in the following situations:

- When the engine switch is turned to the “LOCK” position (vehicles without smart entry & start system) or off (vehicles with smart entry & start system).
- If only the TRC/A-TRC system is turned off, the TRC/A-TRC will turn on when vehicle speed increases.
If the TRC, A-TRC, VSC and Trailer Sway Control systems are turned off, automatic re-enabling will not occur when vehicle speed increases.

■ Operating conditions of the hill-start assist control

- ▶ Vehicles with automatic transmission
 - When on an uphill: The shift lever is in a position other than P, R and N.
 - When on a downhill: The shift lever is in a position R.
 - When the vehicle is stopped.
 - The parking brake is not set.
 - The accelerator pedal is not depressed.
- ▶ Vehicles with manual transmission
 - When on an uphill: The shift lever is in a position other than R.
 - When on a downhill: The shift lever is in a position R.
 - When the vehicle is stopped.
 - The parking brake is not set.
 - The accelerator pedal is not depressed.

■ Automatic system cancelation of the hill-start assist control

- ▶ Vehicles with automatic transmission
 - When on an uphill: The shift lever is in a position P, R and N.
 - When on a downhill: The shift lever is in a position other than R.
 - The accelerator pedal is depressed.
 - The parking brake is set.
 - Maximum 2 seconds elapse after the brake pedal is released.
- ▶ Vehicles with manual transmission
 - When on an uphill: The shift lever is in a position R.
 - When on a downhill: The shift lever is in a position other than R.
 - The accelerator pedal is depressed.
 - The parking brake is set.
 - Maximum 2 seconds elapse after the brake pedal is released.

■ Operating conditions of emergency brake signal

When the following three conditions are met, the emergency brake signal will operate:

- The emergency flashers are off.
- Actual vehicle speed exceeds approximately 55 km/h (35 mph).
- The brake pedal is depressed in a manner that cause the system to judge from the vehicle deceleration that this is a sudden braking operation.

■ Automatic system cancelation of emergency brake signal

The emergency brake signal will turn off in any of the following situations:

- The emergency flashers are turned on.
- The brake pedal is released.
- The system judges from the vehicle deceleration that is not a sudden braking operation.

■ If the slip indicator light comes on

It may indicate a malfunction in the TRC, A-TRC, VSC, Trailer Sway Control or hill-start assist control systems. Consult any authorized Toyota dealer or repairer, or another duly qualified and equipped professional.

 **WARNING****■ The ABS does not operate effectively when**

- The limits of tire gripping performance have been exceeded (such as excessively worn tires on a snow covered road).
- The vehicle hydroplanes while driving at high speed on the wet or slick road.

■ Stopping distance when the ABS is operating may exceed that of normal conditions

The ABS is not designed to shorten the vehicle's stopping distance. Always maintain a safe distance from the vehicle in front of you, especially in the following situations:

- When driving on dirt, gravel or snow-covered roads
- When driving with tire chains
- When driving over bumps in the road
- When driving over roads with potholes or uneven surfaces

■ TRC/A-TRC may not operate effectively when

Directional control and power may not be achievable while driving on slippery road surfaces, even if the TRC/A-TRC system is operating. Drive the vehicle carefully in conditions where stability and power may be lost.

■ Hill-start assist control

- Do not overly rely on the hill-start assist control. The hill-start assist control may not operate effectively on steep inclines and roads covered with ice.
- Unlike the parking brake, the hill-start assist control is not intended to hold the vehicle stationary for an extended period of time. Do not attempt to use the hill-start assist control to hold the vehicle on an incline, as doing so may lead to an accident.

■ When the VSC/Trailer Sway Control is activated

The slip indicator light flashes. Always drive carefully. Reckless driving may cause an accident. Exercise particular care when the indicator light flashes.

 **WARNING****■ When the TRC/A-TRC/VSC/Trailer Sway Control systems are turned off**

Be especially careful and drive at a speed appropriate to the road conditions. As these are the systems to help ensure vehicle stability and driving force, do not turn the TRC/A-TRC/VSC/Trailer Sway Control systems off unless necessary.

■ Replacing tires

Make sure that all tires are of the specified size, brand, tread pattern and total load capacity. In addition, make sure that the tires are inflated to the recommended tire inflation pressure level.

The ABS, TRC, A-TRC, VSC, Trailer Sway Control, hill-start assist control and downhill assist control systems will not function correctly if different tires are installed on the vehicle.

Contact any authorized Toyota dealer or repairer, or another duly qualified and equipped professional for further information when replacing tires or wheels.

■ Handling of tires and the suspension

Using tires with any kind of problem or modifying the suspension will affect the driving assist systems, and may cause the system to malfunction.

■ Trailer Sway Control precaution

The Trailer Sway Control system is not able to reduce trailer sway in all situations. Depending on many factors such as the conditions of the vehicle, trailer, road surface, and driving environment, the Trailer Sway Control system may not be effective. Refer to your trailer owner's manual for information on how to tow your trailer properly.

■ If trailer sway occurs (vehicles with Trailer Sway Control)

Observe the following precautions.

Failing to do so may cause death or serious injury.

- Firmly grip the steering wheel. Steer straight ahead.
Do not try to control trailer swaying by turning the steering wheel.
- Begin releasing the accelerator pedal immediately but very gradually to reduce speed.
Do not increase speed. Do not apply vehicle brakes.

If you make no extreme correction with the steering or brakes, your vehicle and trailer should stabilize. (→P. 231)

Downhill assist control system*

The downhill assist control system helps to prevent excessive speed on steep downhill slopes.

The system will operate when the vehicle is traveling under 30 km/h (18 mph), the front-wheel drive control switch is in the L4 or H4 position and the rear differential is not locked.

System operation

Press the “DAC” switch. The downhill assist control system indicator light comes on and the system will operate.

When the system is in operation, the slip indicator light will flash, and the stop lights/high mounted stop lights will be lit.

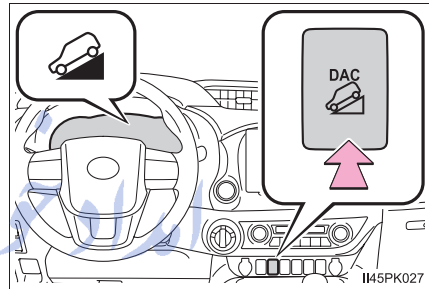

تلفن شبانه روزی: ۰۲۱-۸۸۸۶۲۰۸۵

FarmaSOS.com

■ Operating tips

- ▶ Vehicles with automatic transmission

The system will operate when the shift lever is in a position other than P, however to make effective use of the system it is recommended that the shift lever be shifted to range 2 or 1 of S.

- ▶ Vehicles with manual transmission

To make effective use of the system, it is recommended to drive in a low gear.

■ If the downhill assist control system indicator flashes

- In the following situations, the indicator flashes and the system will not operate:

- The front-wheel drive control switch is in the H2 position.
- The shift lever is in P. (vehicles with automatic transmission)
- The rear differential is locked. (if equipped)
- The accelerator or brake pedal is depressed.
- The vehicle speed exceeds approximately 30 km/h (18mph).
- The brake system overheats.

The system will cease operation. At this time, a buzzer sounds, the downhill assist control system indicator flashes and "TRC turned off" is shown on the multi-information display. Refrain from using the system until the downhill assist control system indicator stays on and "TRC turned off" displayed on the multi-information display goes out. (The vehicle can be driven normally during this time.)

- In the following situations, the indicator flashes to alert the driver, but the system will operate:

- The shift lever is in N. (vehicles with automatic transmission)
- The shift lever is in N and the clutch pedal is depressed. (vehicles with manual transmission)
- The "DAC" switch is turned off while the system is operating.

The system will gradually cease operation. The indicator will flash during operation, and then go off when the system is fully off.

■ Sounds and vibrations caused by the downhill assist control system

- A sound may be heard from the engine compartment when the engine is started or just after the vehicle begins to move. This sound does not indicate that a malfunction has occurred in downhill assist control system.
- Either of the following conditions may occur when the downhill assist control system is operating. None of these are indicators that a malfunction has occurred.
 - Vibrations may be felt through the vehicle body and steering.
 - A motor sound may be heard after the vehicle comes to a stop.

■ System malfunction

- The downhill assist control system indicator does not come on when the engine switch is turned to the “ON” position (vehicles without smart entry & start system) or IGNITION ON mode (vehicles with smart entry & start system).
- The downhill assist control system indicator does not come on when the “DAC” switch is pressed.
- The slip indicator comes on.

In the above cases, have your vehicle checked by any authorized Toyota dealer or repairer, or another duly qualified and equipped professional.

WARNING

■ When using downhill assist control system

- Do not rely overmuch on the downhill assist control system. This function does not extend the vehicle’s performance limitations. Always thoroughly check the road conditions, and drive safely.
- Vehicles with manual transmission: Drive in a low gear. Driving in a high gear when using downhill assist control system may cause the engine to stall, which may lose the brake effectiveness and lock the tires, resulting in an accident.
- Vehicles with manual transmission: On a steep slope, use the engine braking efficiently. If the vehicle is driven in N or with the clutch pedal depressed on a steep slope, the load on the brake increases and controlling the vehicle speed may be impossible, resulting in an accident.

■ The system may not operate on the following surfaces, which may lead to an accident causing death or serious injury

- Slippery surfaces such as wet or muddy roads
- Icy surface
- Unpaved roads

DPF (Diesel Particulate Filter) system*

When the deposit collected by the filter reaches a predetermined amount, it is automatically regenerated.

◆ Regeneration

Regeneration is performed as necessary in accordance with driving conditions.

◆ System characteristics

The DPF system has the following characteristics:

- Idle speed increases during regeneration
- The smell of the exhaust gas differs from that of a conventional diesel vehicle
- White smoke may be emitted from the exhaust pipe during regeneration. However, this does not indicate a malfunction.

DPF system failure warning

- ▶ Vehicles without DPF system switch
- If the DPF system warning message “DPF FULL SEE OWNER’S MANUAL”/“DPF full See owner’s manual” appears on the display, drive continuously. (→P. 581)
- If the DPF system warning message “DPF FULL VISIT YOUR DEALER”/“DPF full Visit your dealer” appears on the display and the malfunction indicator lamp comes on, have the vehicle inspected by any authorized Toyota dealer or repairer, or another duly qualified and equipped professional immediately.

► Vehicles with DPF system switch

- If the DPF system warning message “DPF FULL MANUAL REGENERATION REQUIRED SEE OWNER’S MANUAL”/“DPF full Manual regeneration required See owner’s manual” appears on the display, follow the procedure below to regenerate.

- 1 Stop the vehicle in a safe place.
- 2 Shift the shift lever to P (automatic transmission) or N (manual transmission), and firmly set the parking brake.

Do not stop the engine.

Also, make sure that there are no flammable materials near the exhaust pipe. (→P. 366)

Check the engine is warmed up. If the engine is cold, warm up the engine by depressing the accelerator pedal.*1

- 3 Press the DPF system switch.

The DPF system warning message shown in the illustration appears on the display, and the idling engine speed will increase.

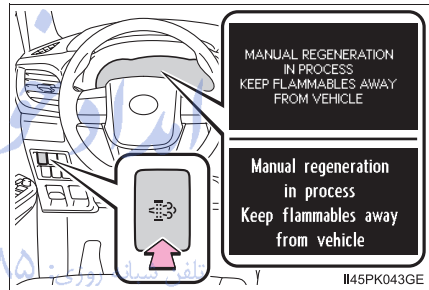

Regeneration will take around 30 - 40 minutes to complete.*2

When the DPF system warning message goes out, the idling engine speed will have finished returning to normal.

The DPF system switch may not operate when the vehicle is higher than 4000 m (13123 ft.) above sea level.

*1: Depending on the situation, it may be necessary to depress the accelerator pedal until the engine speed is increased to 3000 rpm. If the engine coolant temperature or exhaust gas temperature is low, it may take a long time to regenerate, or regeneration may be impossible.

*2: Time required for regeneration differs in accordance with the outside temperature. Also, if the engine speed is still approximately 2000 rpm 10 minutes after pressing the DPF system switch, the exhaust gas temperature may be low. In this case, depress the accelerator pedal to run the engine at approximately 3000 rpm for a while.

- If the DPF system warning message “DPF FULL VISIT YOUR DEALER”/“DPF full Visit your dealer” appears on the display and the malfunction indicator lamp comes on, have the vehicle inspected by any authorized Toyota dealer or repairer, or another duly qualified and equipped professional immediately.

■ Regeneration with the DPF system switch (if equipped)

- After pressing the DPF system switch, depressing the accelerator pedal or clutch pedal (manual transmission) will stop regeneration. If regeneration has been stopped, restart regeneration as soon as possible.
- After regeneration is finished, race the engine several time to clean the exhaust system.

■ DPF system warning

Under the following driving conditions, the DPF system warning message may come on earlier than normal.*

- When only driving at low speeds (for example 20 km/h [12 mph] or below).
- If the engine is turned on and off frequently (if the engine is not left running for more than 10 minutes at a time).

*: Differs in accordance with weather, driving conditions, etc.

⚠ WARNING

■ During regeneration

Observe the following precautions.

Failure to do so may result in serious injury such as burns caused by the hot exhaust pipe and exhaust gases, or may cause a fire.

- Do not stop the vehicle where flammable materials, such as dry grass, are near the exhaust pipe.



- Make sure that there are no people near the exhaust pipe.

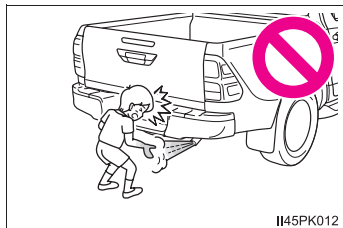

 WARNING

- Vehicles with DPF system switch: Do not carry out regeneration when the vehicle is in an enclosed area, such as a garage.
- Do not touch the exhaust pipe and exhaust gases during regeneration.

■ If the malfunction indicator lamp comes on

The malfunction indicator lamp comes on if you continue driving while the DPF system warning message appears on the display. In this event, damage may be caused to the vehicle or an accident may occur. Have the vehicle inspected by any authorized Toyota dealer or repairer, or another duly qualified and equipped professional immediately.

 NOTICE**■ To prevent the DPF system from failing**

- Do not drive for long periods of time while the DPF system warning message “DPF FULL VISIT YOUR DEALER”/“DPF full Visit your dealer” appears on the display
- Do not use fuel other than the specified type
- Do not use engine oil other than the recommended type
- Do not modify the exhaust pipe

تلفن شبانه روزی: ۰۲۱-۸۸۸۶۲۰۸۵

FarmaSOS.com

Winter driving tips

Carry out the necessary preparations and inspections before driving the vehicle in winter. Always drive the vehicle in a manner appropriate to the prevailing weather conditions.

Preparation for winter

- Use fluids that are appropriate to the prevailing outside temperatures.
 - Engine oil
 - Engine coolant
 - Washer fluid
- Have a service technician inspect the condition of the battery.
- Have the vehicle fitted with four snow tires or purchase a set of tire chains for the rear tires.

Ensure that all tires are the same size and brand, and that chains match the size of the tires.

Before driving the vehicle

Perform the following according to the driving conditions:

- Do not try to forcibly open a window or move a wiper that is frozen. Pour warm water over the frozen area to melt the ice. Wipe away the water immediately to prevent it from freezing.
- To ensure proper operation of the climate control system fan, remove any snow that has accumulated on the air inlet vents in front of the windshield.
- Check for and remove any excess ice or snow that may have accumulated on the exterior lights, vehicle's roof, chassis, around the tires or on the brakes.
- Remove any snow or mud from the bottom of your shoes before getting in the vehicle.

When driving the vehicle

Accelerate the vehicle slowly, keep a safe distance between you and the vehicle ahead, and drive at a reduced speed suitable to road conditions.

When parking the vehicle (in the winter time or in the cold latitudes)

- Park the vehicle and move the shift lever to P (automatic transmission) or 1 or R (manual transmission) without setting the parking brake. The parking brake may freeze up, preventing it from being released. If the vehicle is parked without setting the parking brake, make sure to block the wheels.

Failure to do so may be dangerous because it may cause the vehicle to move unexpectedly, possibly leading to an accident.

- Vehicles with automatic transmission: If the vehicle is parked without setting the parking brake, confirm that the shift lever cannot be moved out of P*.

*: The shift lever will be locked if it is attempted to be shifted from P to any other position without depressing the brake pedal. If the shift lever can be shifted from P, there may be a problem with the shift lock system. Have the vehicle inspected by any authorized Toyota dealer or repairer, or another duly qualified and equipped professional.

Selecting tire chains

Use the correct tire chain size when mounting the snow chains. Chain size is regulated for each tire size.

Regulations on the use of tire chains

Regulations regarding the use of tire chains vary depending on location and type of road. Always check local regulations before installing chains.

■ Tire chain installation

Observe the following precautions when installing and removing chains:

- Install and remove tire chains in a safe location.
- Install tire chains on the rear tires. Do not install tire chains on the front tires.
- Install tire chains on rear tires as tightly as possible. Retighten chains after driving 0.5 - 1.0 km (1/4 - 1/2 mile).
- Install tire chains following the instructions provided with the tire chains.

WARNING

■ Driving with snow tires

Observe the following precautions to reduce the risk of accidents.

Failing to do so may result in a loss of vehicle control and cause death or serious injury.

- Use tires of the specified size.
- Maintain the recommended level of air pressure.
- Do not drive at speeds in excess of the speed limit or the speed limit specified for the snow tires being used.
- Use snow tires on all, not just some wheels.

■ Driving with tire chains

Observe the following precautions to reduce the risk of accidents.

Failing to do so may result in the vehicle being unable to be driven safely, and may cause death or serious injury.

- Do not drive in excess of the speed limit specified for the tire chains being used, or 50 km/h (30 mph), whichever is lower.
- Avoid driving on bumpy road surfaces or over potholes.
- Avoid sudden acceleration, abrupt steering, sudden braking and shifting operations that cause sudden engine braking.
- Slow down sufficiently before entering a curve to ensure that vehicle control is maintained.
- Do not use LDA (Lane Departure Alert) system.



NOTICE

■ Repairing or replacing snow tires (vehicles with tire pressure warning system)

Request repairs or replacement of snow tires from Toyota dealers or legitimate tire retailers.

This is because the removal and attachment of snow tires affects the operation of the tire pressure warning valves and transmitters.

■ Fitting tire chains (vehicles with tire pressure warning system)

The tire pressure warning valves and transmitters may not function correctly when tire chains are fitted.

امداد خودرو فارما

تلفن شبانه روزی: ۰۲۱-۸۸۸۶۲۰۸۵

FarmaSOS.com

امداد خودرو فارما

تلفن شبانه روزی: ۰۲۱-۸۸۸۶۲۰۸۵

FarmaSOS.com

Audio system

5

- 5-1. Basic Operations**
- Audio system types374
 - Steering wheel audio switches.....376
 - AUX port/USB port379
- 5-2. Using the audio system**
- Optimal use of the audio system380
- 5-3. Using the radio**
- Radio operation382
- 5-4. Playing an audio CD and MP3/WMA discs**
- CD player operation.....387
- 5-5. Using an external device**
- Listening to an iPod397
 - Listening USB memory device405
 - Using the AUX port.....412
- 5-6. Using Bluetooth® devices**
- Bluetooth® audio/phone.....413
 - Using the steering wheel switches418
 - Registering a Bluetooth® device419
- 5-7. "SETUP" menu**
- Using the "SETUP" menu ("Bluetooth*" menu).....420
 - Using the "SETUP" menu ("TEL" or "PHONE" menu)426
- 5-8. Bluetooth® Audio**
- Operating a Bluetooth® enabled portable player433
- 5-9. Bluetooth® Phone**
- Making a phone call.....435
 - Receiving a phone call.....437
 - Speaking on the phone.....438
- 5-10. Bluetooth®**
- Bluetooth®440

*: The Bluetooth® word mark and logos are registered trademarks owned by Bluetooth SIG, Inc.

Audio system types*

- ▶ Vehicles with navigation system or multimedia system
Refer to the “Navigation and multimedia system Owner’s manual”.
- ▶ Vehicles without navigation system or multimedia system
CD player with AM/FM radio
- Type A

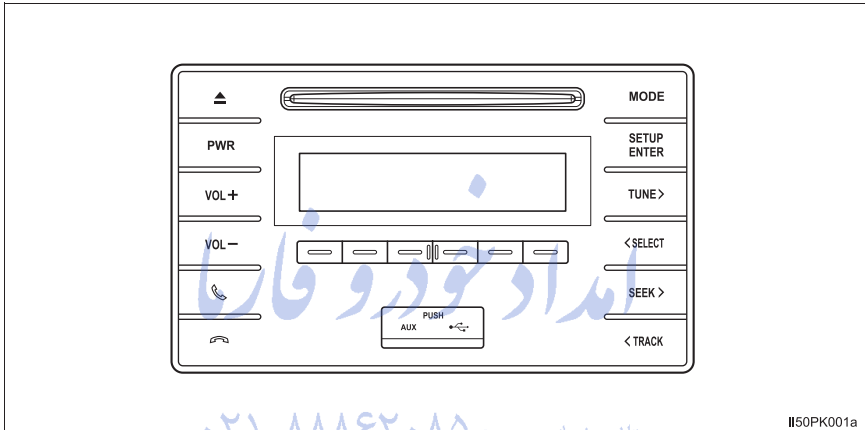

- Type B

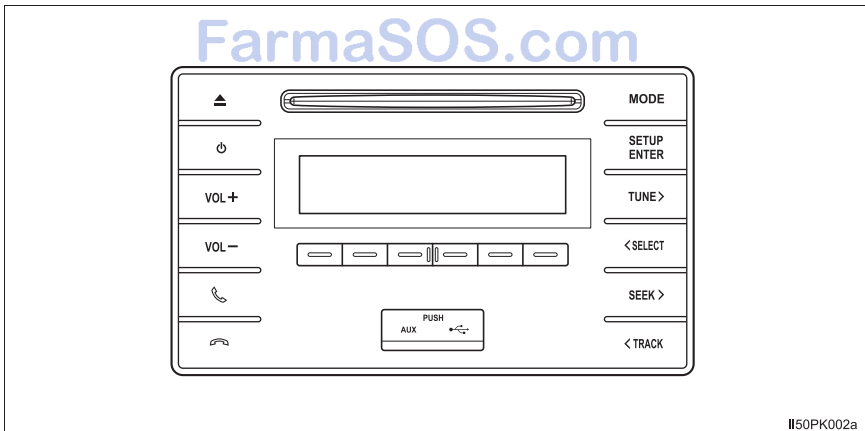

This illustration is for a left-hand drive vehicle. Some button positions are reversed for right-hand drive vehicles. (type B only)

*: If equipped

■ Using cellular phones

Interference may be heard through the audio system's speakers if a cellular phone is being used inside or close to the vehicle while the audio system is operating.

WARNING

■ Certification for the disc player

CAUTION

This product is a class 1 laser product classified under the Safety of laser products, IEC 60825-1:2007.

CLASS 1 LASER PRODUCT

NOTICE

■ To prevent battery discharge

Do not leave the audio system on longer than necessary with the engine stopped.

■ To avoid damaging the audio system

Take care not to spill drinks or other fluids over the audio system.

تلفن شبانه روزی: +۸۵-۸۸۸۶۲-۲۱

FarmaSOS.com

Steering wheel audio switches*

Some audio features can be controlled using the switches on the steering wheel.

Operation may differ depending on the type of audio system or navigation system. For details, refer to the manual provided with the audio system or navigation system.

- ① Volume
- ② Radio mode:
Selects a radio station
CD mode:
Selects a track and file (MP3 and WMA)
Bluetooth® audio mode:
Selects a track
iPod mode:
Selects a song
USB memory mode:
Selects a file
- ③ Power on, select audio source

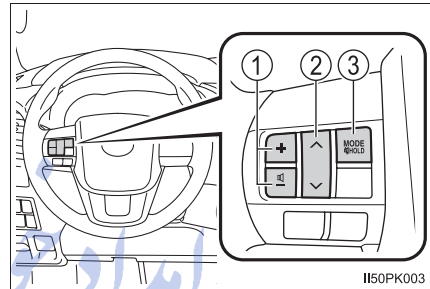

تلفن شبانه روزی: ۰۸۵ ۸۸۸۶۲ ۰۲۴
FarmaSOS.com

*: If equipped

Turning on the power

Press the “MODE” switch when the audio system is turned off.

Changing the audio source

Press the “MODE” switch when the audio system is turned on. The audio source changes as follows each time the button is pressed. If a mode cannot be used, it will be skipped.

AM→FM1→FM2*→CD mode→iPod or USB memory→
Bluetooth® audio*→AUX

*: If equipped

Adjusting the volume

Press the “+” switch to increase the volume and the “-” switch to decrease the volume.

Hold down the switch to continue increasing or decreasing the volume.

Silencing a sound

Press and hold the “MODE” switch.

To cancel, press and hold the switch again.

Selecting a radio station

- 1 Press the “MODE” switch to select the radio mode.
- 2 Press the “^” or “v” switch to select a preset station.

To scan for receivable stations, press and hold the switch until you hear a beep.

Selecting a track/file or song

- 1 Press the “MODE” switch to select the CD, Bluetooth® audio, iPod or USB memory mode.
- 2 Press the “^” or “v” switch to select the desired track/file or song.

Selecting an album

- 1 Press the “MODE” switch to select Bluetooth® audio mode.
- 2 Press and hold the “^” or “v” switch until you hear a beep.

Selecting a folder (MP3 and WMA or USB memory)

- 1 Press the “MODE” switch to select CD or USB memory mode.
- 2 Press and hold the “^” or “v” switch until you hear a beep.

⚠ WARNING**■ To reduce the risk of an accident**

Exercise care when operating the audio switches on the steering wheel.

تلفن شبانه روزی: ۰۲۱-۸۸۸۶۲۰۸۵

FarmaSOS.com

AUX port/USB port

Connect an iPod, USB memory device or portable audio player to the AUX port/USB port as indicated below. Press the “MODE” button to select “iPod”, “USB” or “AUX”.

Connecting using the AUX port/USB port

■ iPod

Open the cover and connect an iPod using an iPod cable.

Turn on the power of the iPod if it is not turned on.

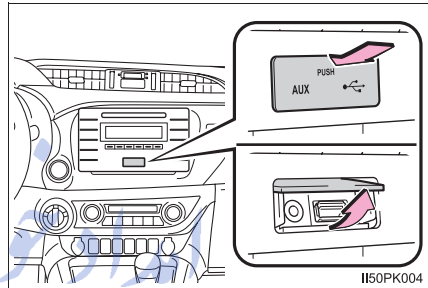

■ USB memory

Open the cover and connect the USB memory device.

Turn on the power of the USB memory device if it is not turned on.

■ Portable audio player

Open the cover and connect the portable audio player.

Turn on the power of the portable audio player if it is not turned on.

⚠ WARNING

■ While driving

Do not connect a device or operate the device controls.

⚠ NOTICE

■ To prevent damage to portable audio device or its terminal

- Do not leave the portable audio device in the vehicle. The temperature inside the vehicle may become high, resulting in damage to the device.
- Do not push down on or apply unnecessary pressure to the portable audio device while it is connected.
- Do not insert foreign objects into the port.

Optimal use of the audio system

The sound quality, volume balance and ASL settings can be adjusted.

- ① Displays the “SETUP” menu/
Selecting the mode
- ② Changes the following settings
 - Sound quality and volume balance
→P. 380
 - The sound quality and balance setting can be changed to produce the best sound.
 - Automatic Sound Levelizer
→P. 381

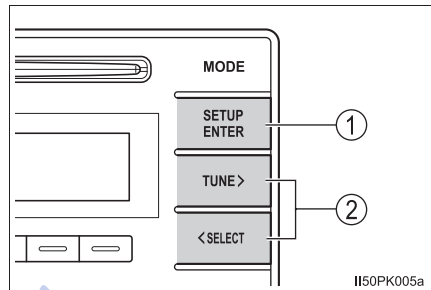

Using the audio control function

■ Changing sound quality modes

- 1 Press the “SETUP ENTER” button
- 2 Press the “TUNE >” or “< SELECT” button to select “Sound Setting”, and press the “SETUP ENTER” button.
- 3 Press the “TUNE >” or “< SELECT” button as corresponds to the desired mode.
“BASS”, “TREBLE”, “FADER”, “BALANCE”, or “ASL” can be selected.
- 4 Press the “SETUP ENTER” button.

■ Adjusting sound quality

Pressing the “TUNE >” or “< SELECT” button adjusts the level.

Sound quality mode	Mode displayed	Level	Press the “< SELECT”	Press the “TUNE >”
Bass*1	“BASS”	-5 to 5	Low	High
Treble*1	“TREBLE”	-5 to 5		
Front/rear volume balance*2	“FADER”	F7 to R7	Shifts to rear	Shifts to front
Left/right volume balance	“BALANCE”	L7 to R7	Shifts to left	Shifts to right

*1: The sound quality level is adjusted individually in each audio mode.

*2: For the vehicles with 2 speakers system, the sound will be mute if the sound balance is adjusted to the maximum level at the rear.

Press the “SETUP ENTER” button or  (BACK) to return to the sound setting menu.

■ Adjusting the Automatic Sound Levelizer (ASL)

When ASL is selected, press the “TUNE >” or “< SELECT” button to change the amount of ASL.

“LOW”, “MID”, “HIGH”, or “OFF” can be selected.

ASL automatically adjusts the volume and tone quality according to vehicle speed.

Press the “SETUP ENTER” button or  (BACK) to return to the sound setting menu.

Radio operation

Press the “MODE” button until “AM” or “FM” is displayed.

► Type A

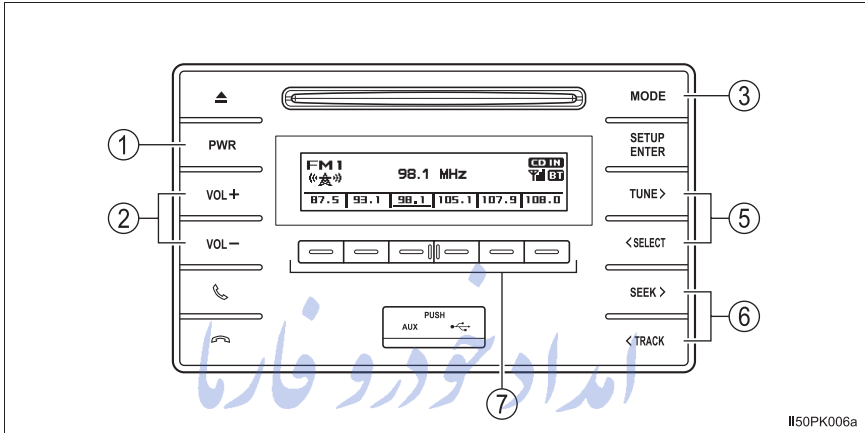

II50PK006a

تلفن شبانه روزی: ۰۲۱-۸۸۸۶۲۰۸۵

FarmaSOS.com

► Type B

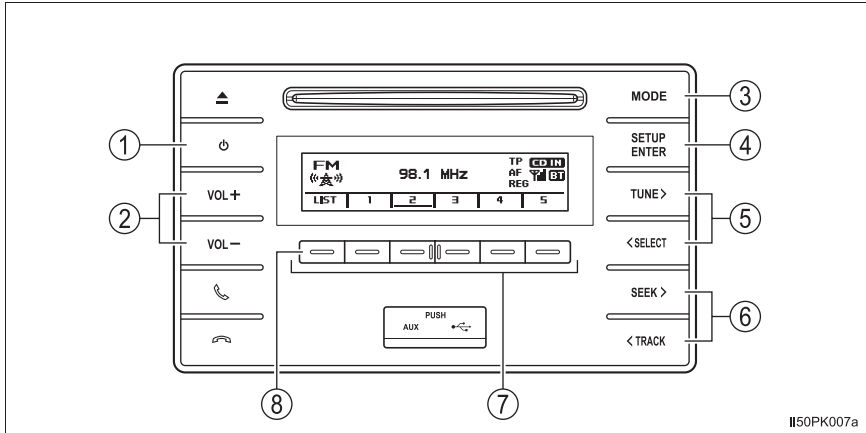

- | | |
|--|---|
| ① Power | ⑤ Adjusting the frequency |
| ② Volume | ⑥ Seeking the frequency |
| ③ AM/FM mode button | ⑦ Station selectors |
| ④ AF/region code/TA mode setup (type B only) | ⑧ Displaying the station list (type B only) |

Setting station presets

- 1 Search for the desired stations by pressing the “TUNE >”, “< SELECT”, “SEEK >” or “< TRACK” button.
- 2 Press and hold one of the station selectors () to be set until you hear a beep.

Using the station list (type B only)

■ Updating the station list

- 1 Press  (LIST).

The station list will be displayed.

- 2 Press  (UPDATE) to update the list.

“Updating” is displayed while the searching is in process, and then available stations will be listed on the display.

To cancel the updating process, press  (BACK).

■ Selecting a station from the station list

- 1 Press  (LIST).

The station list will be displayed.

- 2 Press the “TUNE >” or “< SELECT” button to select a station.

- 3 Press the “SETUP ENTER” button to tune in the station.

To return to the previous display, press  (BACK).

RDS (Radio Data System) (type B only)

This feature allows your radio to receive station.

■ Listening to stations of the same network

- 1 Press the “SETUP ENTER” button. تلفن شبانه روزی

- 2 Press the “TUNE >” or “< SELECT” button to select “RADIO”, and press the “SETUP ENTER” button.

- 3 Press the “TUNE >” or “< SELECT” button as corresponds to the desired mode: “FM AF” or “Region code”.

- 4 Press the “SETUP ENTER” button to select “ON” or “OFF”.

FM AF ON mode:

The station among those of the same network with strong reception is selected.

Region code ON mode:

The station among those of the same network with strong reception and broadcasting the same program is selected.

■ Traffic information

- 1 Press the “SETUP ENTER” button.
- 2 Press the “TUNE >” or “< SELECT” button to select “RADIO”, and press the “SETUP ENTER” button.
- 3 Press the “TUNE >” or “< SELECT” button to select “FM TA” mode.
- 4 Press the “SETUP ENTER” button to select “ON” or “OFF”.

TP mode:

The system automatically switches to traffic information when a broadcast with a traffic information signal is received.

The station returns to the previous one when the traffic information ends.

TA mode:

The system automatically switches to traffic information when a broadcast with a traffic information signal is received. In FM modes, the system will be mute unless traffic information is being broadcast.

The audio system returns to the previous mode when the traffic information ends.

تلفن شبانه روزی: ۰۲۱-۸۸۸۶۲۰۸۵

FarmaSOS.com

■ EON (Enhanced Other Network) system (for traffic announcement function) (type B only)

If the RDS station (with EON data) you are listening to is not broadcasting a traffic information program and the audio system is in the TA (traffic announcement) mode, the radio will be switched automatically to a station broadcasting a traffic information program in the EON AF list when traffic information begins.

■ When the battery is disconnected

Stations presets are erased.

■ Reception sensitivity

- Maintaining perfect radio reception at all times is difficult due to the continually changing position of the antenna, differences in signal strength and surrounding objects, such as trains, transmitters, etc.
- The radio antenna is mounted on the roof. The antenna can be removed from the base by turning it.

**NOTICE****■ To prevent damage, remove the antenna in the following cases**

- The antenna will touch the ceiling of a garage.
- A cover will be put on the roof.
- When driving through an automatic car wash.
- Any other cases where there is a risk of touching surrounding parts.

CD player operation

Insert a disc, press the “MODE” button to begin listening to a CD.

► Type A

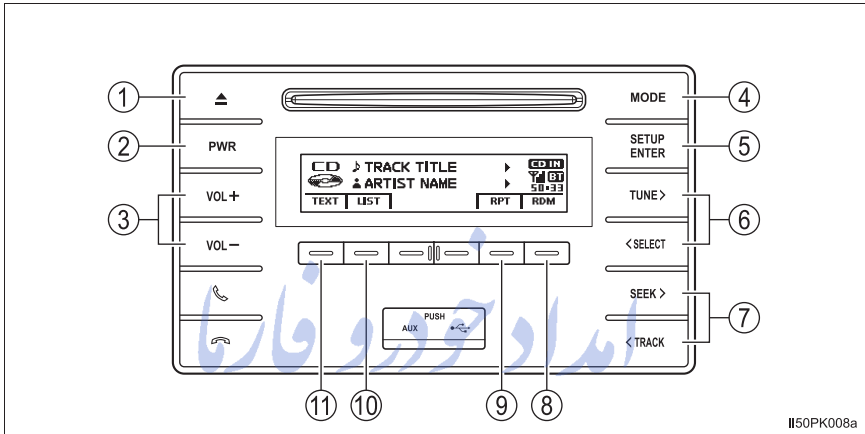

تلفن شبانه روزی: ۰۲۱-۸۸۸۶۲۰۸۵

FarmaSOS.com

► Type B

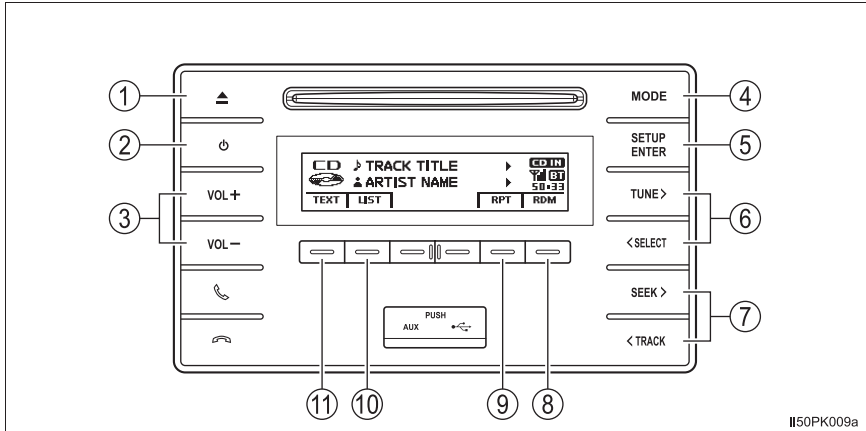

- | | |
|--|---|
| ① CD eject | ⑦ Selecting a track, fast forwarding or rewinding |
| ② Power | ⑧ Random play or back button |
| ③ Volume | ⑨ Repeat play |
| ④ Changing the audio source/playback | ⑩ Displaying track list |
| ⑤ Selecting a track from the list | ⑪ Displaying text message |
| ⑥ Moving the cursor to select a desired item from the list | |

Loading CDs

Insert a CD.

Ejecting CDs

Press  and remove the CD.

Using the CD player

■ Selecting a track

Press the “SEEK >” or “< TRACK” button to move up or down until the desired track number is displayed.

■ Selecting a track from a track list

1 Press  (LIST).

The track list will be displayed.

2 Press the “TUNE >” or “< SELECT” button to select a track, and press the “SETUP ENTER” button.

To return to the previous display, press  (BACK).

■ Fast-forwarding and rewinding tracks

Press and hold the “SEEK >” or “< TRACK” button.

■ Random play

Press  (RDM).

To cancel, press  (RDM) again.

■ Repeat play

Press  (RPT).

To cancel, press  (RPT) again.

■ Switching the display



Press  (TEXT) to display or hide the CD title.

If there are continuing texts,  is displayed.

Press and hold  (TEXT) to display the remaining texts.

Playing back MP3 and WMA discs

■ Selecting folders one at a time

Press  (<FOLDER) or  (FOLDER>) to select the desired folder.

■ Selecting a folder and file from folder list

1 Press  (LIST).

The folder list will be displayed.

2 Press the “TUNE >” or “< SELECT” button to select a folder and file, and press the “SETUP ENTER” button.

To return to the previous display, press  (BACK).

■ Returning to the first folder

Press and hold  (<FOLDER) until you hear a beep.

■ Selecting a file

Press the “SEEK >” or “< TRACK” button to select the desired file.

■ Fast-forwarding and rewinding files

Press and hold the “SEEK >” or “< TRACK” button.

■ Random play

Pressing  (RDM) changes modes in the following order:
Folder random→Disc random→Off

■ Repeat play

Pressing  (RPT) changes modes in the following order:
File repeat→Folder repeat*→Off

*: Available except when RDM (random play) is selected

■ Switching the display

Press  (TEXT) to display or hide the album title.

If there are continuing texts,  is displayed.

Press and hold  (TEXT) to display the remaining texts.

■ Display

Depending on the contents recorded, the characters may not be displayed properly or may not be displayed at all.

■ Error messages

If an error message is displayed, refer to the following table and take the appropriate measures. If the problem is not rectified, take the vehicle to any authorized Toyota dealer or repairer, or another duly qualified and equipped professional.

Message	Cause/Correction procedures
"ERROR"	This indicates a problem either in the CD or inside the player.
"CD CHECK"	The CD may be dirty, damaged or inserted upside-down.
"WAIT"	Operation has stopped due to a high temperature inside the player. Wait for a while and then press the "MODE" button. If the CD still cannot be played back, contact any authorized Toyota dealer or repairer, or another duly qualified and equipped professional.
"NO SUPPORT"	This indicates that the MP3/WMA file is not included in the CD.

■ Discs that can be used

Discs with the marks shown below can be used.

Playback may not be possible depending on recording format or disc features, or due to scratches, dirt or deterioration.



CDs with copy-protect features may not play correctly.

■ CD player protection feature

To protect the internal components, playback is automatically stopped when a problem is detected while the CD player is being used.

■ If a CD is left inside the CD player or in the ejected position for extended periods

The CD may be damaged and may not play properly.

■ Lens cleaners

Do not use lens cleaners. Doing so may damage the CD player.

■ MP3 and WMA files

MP3 (MPEG Audio LAYER3) is a standard audio compression format.

Files can be compressed to approximately 1/10 of their original size by using MP3 compression.

WMA (Windows Media Audio) is a Microsoft audio compression format.

This format compresses audio data to a size smaller than that of the MP3 format.

There is a limit to the MP3 and WMA file standards and to the media/formats recorded by them that can be used.

● MP3 file compatibility

- Compatible standards
MP3 (MPEG1 LAYER3, MPEG2 LSF LAYER3)
- Compatible sampling frequencies
MPEG1 LAYER3: 32, 44.1, 48 (kHz)
MPEG2 LSF LAYER3: 16, 22.05, 24 (kHz)
- Compatible bit rates (compatible with VBR)
MPEG1 LAYER3: 32—320 (kbps)
MPEG2 LSF LAYER3: 8—160 (kbps)
- Compatible channel modes: stereo, joint stereo, dual channel and monaural

● WMA file compatibility

- Compatible standards
WMA Ver. 7, 8, 9
- Compatible sampling frequencies
32, 44.1, 48 (kHz)
- Compatible bit rates (only compatible with 2-channel playback)
Ver. 7, 8: CBR 48—192 (kbps)
Ver. 9: CBR 48—320 (kbps)

- Compatible media

Media that can be used for MP3 and WMA playback are CD-Rs and CD-RWs.

Playback in some instances may not be possible, depending on the status of the CD-R or CD-RW. Playback may not be possible or the audio may jump if the disc is scratched or marked with fingerprints.

- Compatible disc formats

The following disc formats can be used.

- Disc formats:

- CD-ROM Mode 1 and Mode 2

- CD-ROM XA Mode 2, Form 1 and Form 2

- File formats:

- ISO9660 Level 1, Level 2, (Romeo, Joliet)

MP3 and WMA files written in any format other than those listed above may not play correctly, and their file names and folder names may not be displayed correctly.

Items related to standards and limitations are as follows.

- Maximum directory hierarchy: 8 levels
- Maximum length of folder names/file names: 32 characters
- Maximum number of folders: 192 (including the root)
- Maximum number of files per disc: 255

- File names

The only files that can be recognized as MP3/WMA and played are those with the extension .mp3 or .wma.

- Multi-sessions

As the audio system is compatible with multi-sessions, it is possible to play discs that contain MP3 and WMA files. However, only the first session can be played.

- ID3 and WMA tags

ID3 tags can be added to MP3 files, making it possible to record the track title and artist name, etc.

The system is compatible with ID3 Ver. 1.0, 1.1, and Ver. 2.2, 2.3 ID3 tags. (The number of characters is based on ID3 Ver. 1.0 and 1.1.)

WMA tags can be added to WMA files, making it possible to record the track title and artist name in the same way as with ID3 tags.

- MP3 and WMA playback

When a disc containing MP3 or WMA files is inserted, all files on the disc are first checked. Once the file check is finished, the first MP3 or WMA file is played. To make the file check finish more quickly, we recommend you do not write in any files other than MP3 or WMA files or create any unnecessary folders.

If the discs contain a mixture of music data and MP3 or WMA format data, only music data can be played.

- Extensions

If the file extensions .mp3 and .wma are used for files other than MP3 and WMA files, they will be mistakenly recognized and played as MP3 and WMA files. This may result in large amounts of interference and damage to the speakers.

- Playback

- To play MP3 file with steady sound quality, we recommend a fixed bit rate of 128 kbps and a sampling frequency of 44.1 kHz.
- CD-R or CD-RW playback may not be possible in some instances, depending on the characteristics of the disc.
- There is a wide variety of freeware and other encoding software for MP3 and WMA files on the market, and depending on the status of the encoding and the file format, poor sound quality or noise at the start of playback may result. In some cases, playback may not be possible at all.
- When files other than MP3 or WMA files are recorded on a disc, it may take more time to recognize the disc and in some cases, playback may not be possible at all.
- Microsoft, Windows, and Windows Media are the registered trademarks of Microsoft Corporation in the U.S. and other countries.

 NOTICE

■ **CDs and adapters that cannot be used**

Do not use the following types of CDs.

Also, do not use 8 cm (3 in.) CD adapters, DualDiscs or printable discs. Doing so may damage the player and/or the CD insert/eject function.

- CDs that have a diameter that is not 12 cm (4.7 in.)

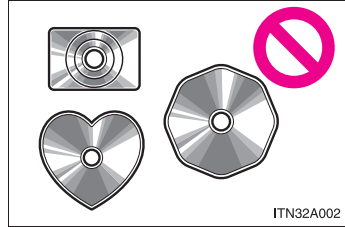

- Low-quality and deformed CDs

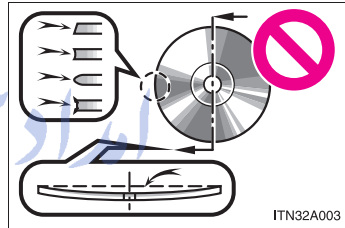

تلفن شبانه روزی: ۰۲۱-۸۸۸۶۲۰۸۵

FarmaSOS.com

 NOTICE

- CDs with a transparent or translucent recording area

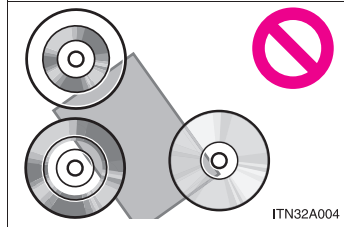

- CDs that have tape, stickers or CD-R labels attached to them, or that have had the label peeled off

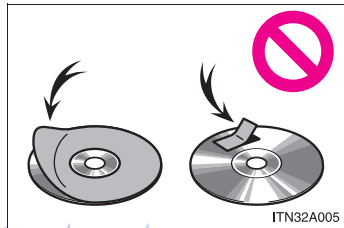

■ **CD Player precautions**

Failure to follow the precautions below may result in serious damage to the CDs or the player itself.

- Do not insert anything other than CDs into the CD slot.
- Do not apply oil to the CD player.
- Store CDs away from direct sunlight. تلفن شبانه روزی: ۰۲۱-۸۸۸۰۰۰۰۰
- Never try to disassemble any part of the CD player.

Listening to an iPod

Connecting an iPod enables you to enjoy music from the vehicle speakers.

Connecting an iPod

→P. 379

Control panel

► Type A

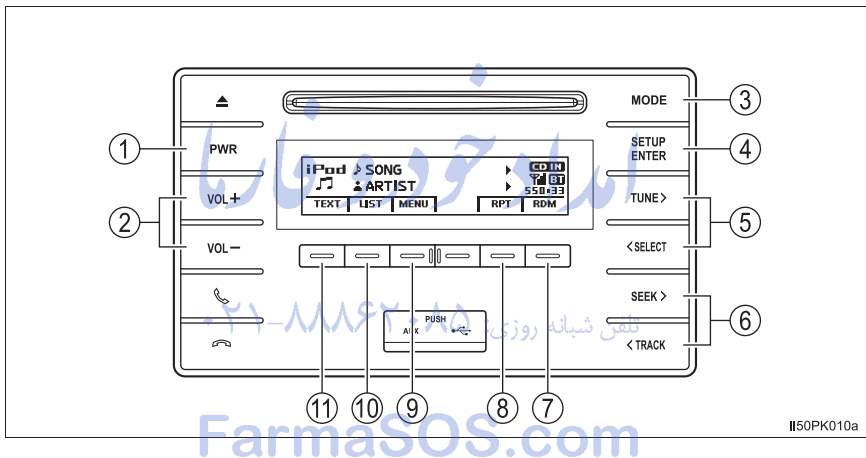

► Type B

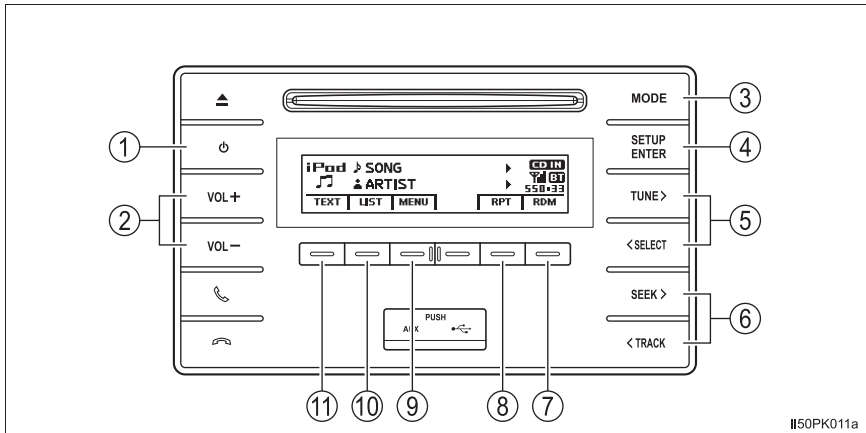

- | | |
|--|--|
| ① Power | ⑥ Selecting a song, fast-forwarding or rewinding |
| ② Volume | ⑦ Random play or back button |
| ③ Changing the audio source/ playback | ⑧ Repeat play |
| ④ Selecting an iPod menu/song from the list | ⑨ iPod menu mode, playback |
| ⑤ Moving the cursor to select a desired item from the list | ⑩ Displaying song list |
| | ⑪ Displaying text message |

Selecting a play mode

- 1 Press (MENU) to select iPod menu mode.
- 2 Pressing the “TUNE >” button changes the play mode in the following order:
 “Playlists” → “Artists” → “Albums” → “Songs” → “Podcasts” → “Genres” → “Composers” → “Audiobooks”
- 3 Press the “SETUP ENTER” button to select the desired play mode.

■ Play mode list

Play mode	First selection	Second selection	Third selection	Fourth selection
"Playlists"	Playlists select	Songs select	-	-
"Artists"	Artists select	Albums select	Songs select	-
"Albums"	Albums select	Songs select	-	-
"Songs"	Songs select	-	-	-
"Podcasts"	Podcasts select	Episodes select	-	-
"Genres"	Genre select	Artists select	Albums select	Songs select
"Composers"	Composers select	Albums select	Songs select	-
"Audiobooks"	Audiobooks select	Chapter select	-	-

■ Selecting a list

- 1 Press the "TUNE >" or "< SELECT" button to display the first selection list.
- 2 Press the "SETUP ENTER" button to select the desired item and display the second selection list.
- 3 Repeat the same procedure to select the desired item.

To return to the previous selection list, press  (BACK).

Press  (PLAY) to play the desired selection.

Selecting songs

Press the “SEEK >” or “< TRACK” button to select the desired song.

Selecting a song from the song list

- 1 Press  (LIST).

The song list will be displayed.

- 2 Press the “TUNE >” or “< SELECT” button to select a song.

- 3 Press the “SETUP ENTER” button to play the song.

To return to the previous display, press  (BACK).

Fast-forwarding and rewinding songs

Press and hold the “SEEK >” or “< TRACK” button.

Repeat play

Press  (RPT).

To cancel, press  (RPT) again.

Random play

Pressing  (RDM) changes modes in the following order:

Track random → Album random → Off

Switching the display

Press  (TEXT) to display or hide the album title.

If there are continuing texts,  is displayed.

Press and hold  (TEXT) to display the remaining texts.

■ About iPod



- “Made for iPod” and “Made for iPhone” mean that an electronic accessory has been designed to connect specifically to iPod, or iPhone, respectively, and has been certified by the developer to meet Apple performance standards.
- Apple is not responsible for the operation of this device or its compliance with safety and regulatory standards. Please note that the use of this accessory with iPod or iPhone may affect wireless performance.
- iPhone, iPod, iPod classic, iPod nano, iPod shuffle, and iPod touch are trademarks of Apple Inc., registered in the U.S. and other countries.

■ iPod functions

- When an iPod is connected and the audio source is changed to iPod mode, the iPod will resume play from the same point in which it was last used.
- Depending on the iPod that is connected to the system, certain functions may not be available. Disconnecting the device and reconnecting it once again may resolve some malfunctions.
- While connected to the system, the iPod cannot be operated with its own controls. It is necessary to use the controls of the vehicle’s audio system instead.

■ iPod problems

To resolve most problems encountered when using your iPod, disconnect your iPod from the vehicle iPod connection and reset it.

For instructions on how to reset your iPod, refer to your iPod Owner's Manual.

■ Display

→P. 391

■ Error messages

If an error message is displayed, refer to the following table and take the appropriate measures. If the problem is not rectified, take the vehicle to any authorized Toyota dealer or repairer, or another duly qualified and equipped professional.

Message	Cause/Correction procedures
"ERROR"	This indicates a problem in the iPod or its connection.
"NO SONGS"	This indicates that there is no music data in the iPod.
"NO PLAYLIST"	This indicates that some available songs are not found in a selected playlist.
"UPDATE YOUR iPod"	This indicates that the version of the iPod is not compatible. Upgrade your iPod software to the latest version. تلفن شبا: ۰۲۱-۸۸۸۸۸۸۸۸

■ Compatible models

The following iPod®, iPod nano®, iPod classic®, iPod touch® and iPhone® devices can be used with this system.

● Made for

- iPod touch (5th generation)
- iPod touch (4th generation)
- iPod touch (3rd generation)
- iPod touch (2nd generation)
- iPod touch (1st generation)
- iPod classic
- iPod with video
- iPod nano (7th generation)
- iPod nano (6th generation)
- iPod nano (5th generation)
- iPod nano (4th generation)
- iPod nano (3rd generation)
- iPod nano (2nd generation)
- iPod nano (1st generation)
- iPhone 5s
- iPhone 5c
- iPhone 5
- iPhone 4S
- iPhone 4
- iPhone 3GS
- iPhone 3G
- iPhone

Depending on differences between models or software versions etc., some models might be incompatible with this system.

Items related to standards and limitations are as follows:

- Maximum number of lists in device: 9999
- Maximum number of songs in device: 65535
- Maximum number of songs per list: 65535

⚠ WARNING

■ While driving

Do not connect iPod or operate the controls. Doing so may cause an accident, resulting in death or serious injury.



NOTICE

■ To prevent damage to iPod

- Do not leave iPod in the vehicle. The temperature inside the vehicle may become high, resulting in damage to the iPod.
- Do not push down on or apply unnecessary pressure to the iPod while it is connected as this may damage the iPod or its terminal.
- Do not insert foreign objects into the port as this may damage the iPod or its terminal.

امداد خودرو فارما

تلفن شبانه روزی: ۰۲۱-۸۸۸۶۲۰۸۵

FarmaSOS.com

Listening USB memory device

Connecting a USB memory enables you to enjoy music from the vehicle speakers.

Connecting a USB memory

→P. 379

Control panel

► Type A

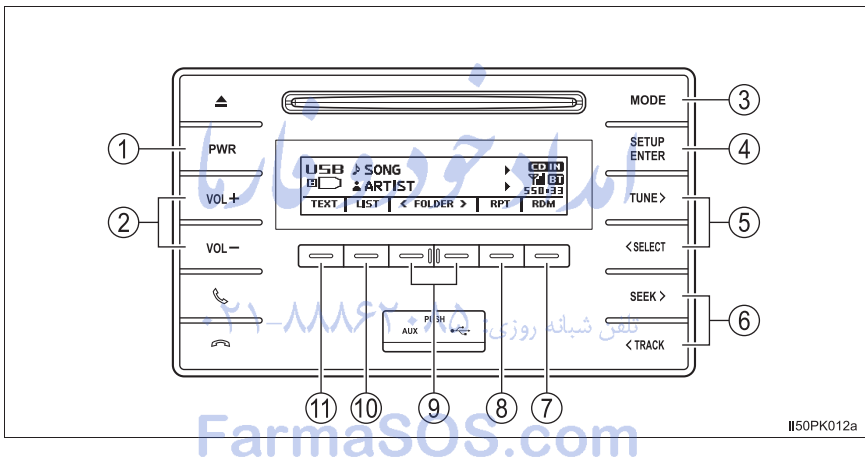

► Type B

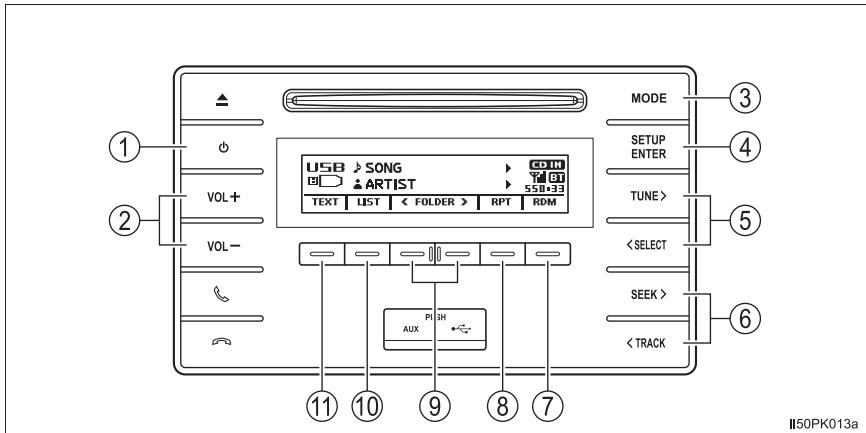

- | | |
|--|--|
| ① Power | ⑥ Selecting a file, fast-forwarding or rewinding |
| ② Volume | ⑦ Random play or back button |
| ③ Changing the audio source/ playback | ⑧ Repeat play |
| ④ Selecting a song, file or folder from the list | ⑨ Selecting a folder |
| ⑤ Moving the cursor to select a desired item from the list | ⑩ Displaying folder list |
| | ⑪ Displaying text message |

Selecting a folder

■ Selecting folders one at a time

Press \square (<FOLDER) or \square (FOLDER>) to select the desired folder.

■ Selecting a folder and file from folder list

1 Press \square (LIST).

The folder list will be displayed.

2 Press the “TUNE >” or “< SELECT” button to select a folder and file, and press the “SETUP ENTER” button.

To return to the previous display, press \square (BACK).

■ Returning to the first folder

Press and hold \square (<FOLDER) until you hear a beep.

Selecting a file

Press the “SEEK >” or “< TRACK” button to select the desired file.

Fast-forwarding and rewinding files

Press and hold the “SEEK >” or “< TRACK” button.

Random play

Pressing \square (RDM) changes modes in the following order:
Folder random → All folder random → Off

Repeat play

Pressing \square (RPT) changes modes in the following order:
File repeat → Folder repeat* → Off

*: Available except when RDM (random play) is selected

Switching the display

Press \square (TEXT) to display or hide the album title.

If there are continuing texts, \blacktriangleright is displayed.

Press and hold \square (TEXT) to display the remaining texts.

■ USB memory functions

- Depending on the USB memory that is connected to the system, the device itself may not be operable and certain functions may not be available. If the device is inoperable or a function is unavailable due to a malfunction (as opposed to a system specification), disconnecting the device and reconnecting it once again may resolve the problem.
- If the USB memory still does not begin operation after being disconnected and reconnected, format the memory.

■ Display

→P. 391

■ Error messages

If an error message is displayed, refer to the following table and take the appropriate measures. If the problem is not rectified, take the vehicle to any authorized Toyota dealer or repairer, or another duly qualified and equipped professional.

Message	Cause/Correction procedures
“ERROR”	This indicates a problem in the USB memory or its connection.
“NO MUSIC”	This indicates that no MP3/WMA files are included in the USB memory.

■ USB memory

- Compatible devices

USB memory that can be used for MP3 and WMA playback

- Compatible device formats

The following device formats can be used:

- USB communication formats: USB2.0 FS (12mbps)
- File formats: FAT12/16/32 (Windows)
- Correspondence class: Mass storage class

MP3 and WMA files written in any format other than those listed above may not play correctly, and their file names and folder names may not be displayed correctly.

Items related to standards and limitations are as follows:

- Maximum directory hierarchy: 8 levels
- Maximum number of folders in a device: 999 (including the root)
- Maximum number of files in a device: 9999
- Maximum number of files per folder: 255

- MP3 and WMA files

MP3 (MPEG Audio LAYER3) is a standard audio compression format.

Files can be compressed to approximately 1/10 of their original size by using MP3 compression.

WMA (Windows Media Audio) is a Microsoft audio compression format.

This format compresses audio data to a size smaller than that of the MP3 format.

There is a limit to the MP3 and WMA file standards and to the media/formats recorded by them that can be used.

- MP3 file compatibility

- Compatible standards

MP3 (MPEG1 LAYER3, MPEG2 LSF LAYER3)

- Compatible sampling frequencies

MPEG1 LAYER3: 32, 44.1, 48 (kHz)

MPEG2 LSF LAYER3: 16, 22.05, 24 (kHz)

- Compatible bit rates (compatible with VBR)

MPEG1 LAYER3: 32—320 (kbps)

MPEG2 LSF LAYER3: 8—160 (kbps)

- Compatible channel modes: stereo, joint stereo, dual channel and monoaural

- WMA file compatibility

- Compatible standards

WMA Ver. 7, 8, 9

- Compatible sampling frequencies

32, 44.1, 48 (kHz)

- Compatible bit rates (only compatible with 2-channel playback)

Ver. 7, 8: CBR 48—192 (kbps)

Ver. 9: CBR 48—320 (kbps)

- File names

The only files that can be recognized as MP3/WMA and played are those with the extension .mp3 or .wma.

- ID3 and WMA tags

ID3 tags can be added to MP3 files, making it possible to record the track title, artist name, etc.

The system is compatible with ID3 Ver. 1.0, 1.1, and Ver. 2.2, 2.3, 2.4 ID3 tags. (The number of characters is based on ID3 Ver. 1.0 and 1.1.)

WMA tags can be added to WMA files, making it possible to record the track title and artist name in the same way as with ID3 tags.

- MP3 and WMA playback

- When a device containing MP3 or WMA files is connected, all files in the USB memory device are checked. Once the file check is finished, the first MP3 or WMA file is played. To make the file check finish more quickly, we recommend that you do not include any files other than MP3 or WMA files or create any unnecessary folders.
- When the USB device is connected and the audio source is changed to USB memory mode, the USB device will start playing the first file in the first folder. If the same device is removed and reinserted (and the contents have not been changed), the USB memory will resume play from the same point in which it was last used.

- Extensions

If the file extensions .mp3 and .wma are used for files other than MP3 and WMA files, they will be skipped (not played). تلفن شبانه روزی

- Playback

- To play MP3 files with steady sound quality, we recommend a fixed bit rate of at least 128 kbps and a sampling frequency of 44.1 kHz.
- There is a wide variety of freeware and other encoding software for MP3 and WMA files on the market, and depending on the status of the encoding and the file format, poor sound quality or noise at the start of playback may result. In some cases, playback may not be possible at all.
- Microsoft, Windows, and Windows Media are registered trademarks of Microsoft Corporation in the U.S.A. and other countries.

**WARNING****■ While driving**

Do not connect USB memory or operate the controls. Doing so may cause an accident, resulting in death or serious injury.

**NOTICE****■ To prevent damage to USB memory**

- Do not leave USB memory in the vehicle. The temperature inside the vehicle may become high, resulting in damage to the USB memory.
- Do not push down on or apply unnecessary pressure to the USB memory while it is connected as this may damage the USB memory or its terminal.
- Do not insert foreign objects into the port as this may damage the USB memory or its terminal.

Using the AUX port

This port can be used to connect a portable audio device and listen to it using the vehicle's speakers.

Connecting a portable player

→P. 379

■ Operating portable audio devices connected to the audio system

The volume can be adjusted using the vehicle's audio controls. All other adjustments must be made on the portable audio device itself.

■ When using a portable audio device connected to the power outlet

Noise may occur during playback. Use the power source of the portable audio device.

امداد خودرو فارما

تلفن شبانه روزی: ۰۲۱-۸۸۸۶۲۰۸۵

FarmaSOS.com

Bluetooth® audio/phone

The following can be performed using Bluetooth® wireless communication:

◆ Bluetooth® audio

The Bluetooth® audio system enables you to enjoy music played on a portable digital audio player (portable player) from the vehicle speakers via wireless communication.

This audio system supports Bluetooth®, a wireless data system capable of playing portable audio music without cables. If your portable player does not support Bluetooth®, the Bluetooth® audio system will not function.

◆ Bluetooth® phone (hands-free phone system)

This system supports Bluetooth®, which allows you to make or receive calls without using cables to connect a cellular phone and the system, and without operating the cellular phone.

تلفن شبانه روزی: ۰۲۱-۸۸۸۶۲۰۸۵

FarmaSOS.com

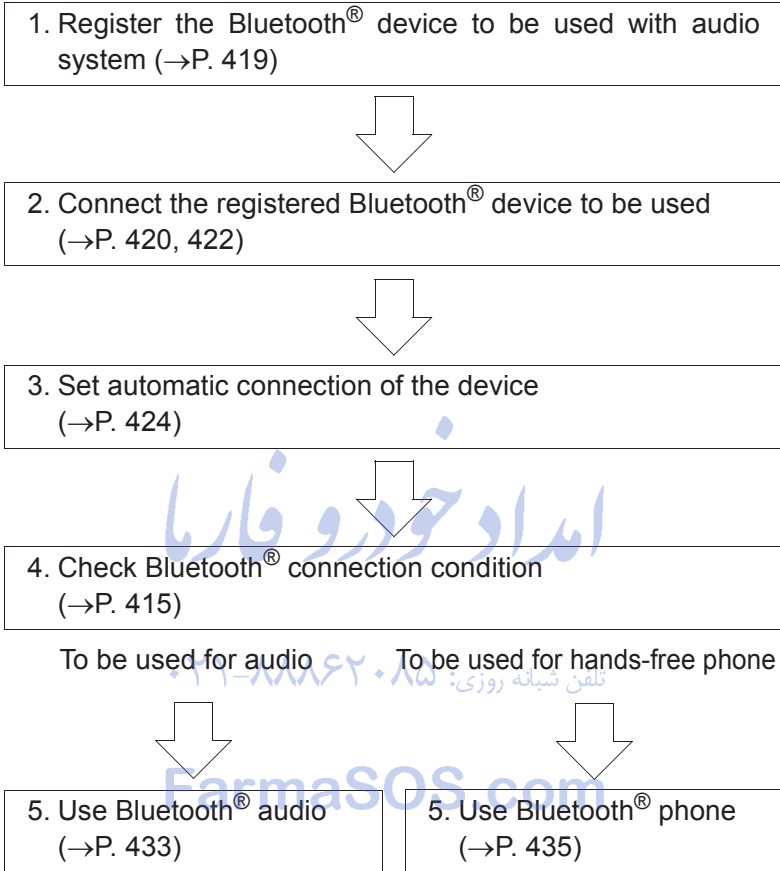
Device registration/connection flow

Audio unit

► Type A

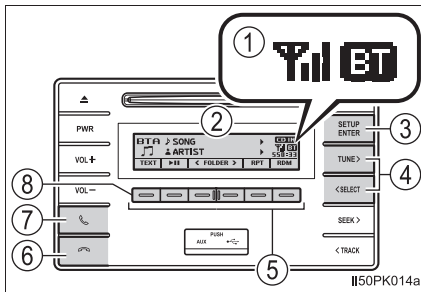

► Type B

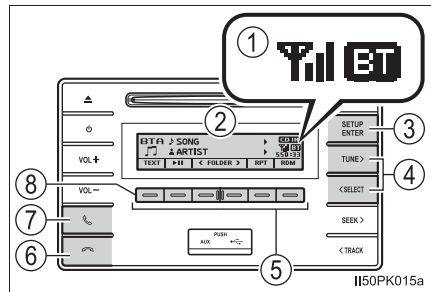

① Bluetooth® connection condition

If “BT” is not displayed, the Bluetooth® audio/phone cannot be used.

② Display

A message, name, number, etc. is displayed.

Lower-case characters and special characters may not be displayed.

③ “SETUP ENTER” button

Displays set up menu or inputs the selected item

④ “TUNE >” or “< SELECT” button

Selects items such as menu and number.

⑤ Selects speed dials (Bluetooth® phone operation)

⑥ On-hook switch

Turns the hands-free system off/ends a call/refuses a call

⑦ Off-hook switch

Turns the hands-free system on/starts a call

⑧ Press and hold:

Displays information that is too long to be displayed at one time on the display (Bluetooth® audio operation)

Microphone

You can use the microphone when talking on the phone.

The person you are speaking to can be heard from the speakers.

To use the hands-free system, you must register your Bluetooth® phone in the system. (→P. 419)

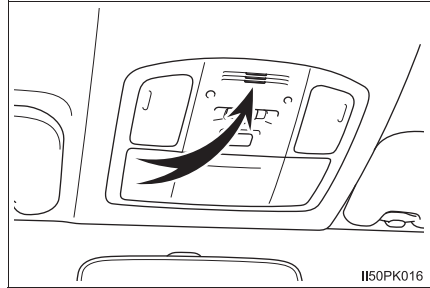

Menu list of the Bluetooth® audio/phone

First menu	Second menu	Third menu	Operation details	
"Bluetooth*"	"Pairing"	-	Registering a Bluetooth® device	
	"List phone"	-	Listing the registered cellular phones	
	"List audio"	-	Listing the registered portable players	
	"Passkey"	-	Changing the pass-key	
	"BT power"	-	Setting automatic connection of the device on or off	
	"Bluetooth* info"	"Device name" "Device address"	-	Displaying the device status
	"Display setting"	-	Setting the automatic connection confirmation display to on or off	
"Initialize"	-	Initializing the settings		

*: The Bluetooth® word mark and logos are registered trademarks owned by Bluetooth SIG, Inc.

First menu	Second menu	Third menu	Operation details
"TEL" or "PHONE"	"Phonebook"	"Add contacts"	Adding a new number
		"Add SD"	Registering a speed dial
		"Delete call history"	Deleting a number stored in the call history
		"Delete contacts"	Deleting a number stored in the phonebook
		"Delete other PB"	Deleting a phonebook's data
	"Auto transfer"	-	Setting automatic transferring of the phonebook to on or off
	"HF sound setting"	"Call volume"	Setting call volume
		"Ringtone volume"	Setting ring tone volume
		"Ringtone"	Setting the ring tone
	"Transfer histories"	-	Transferring the call histories

■ Bluetooth® audio/phone system functions

Depending on the Bluetooth® device, certain functions may not be available.

Using the steering wheel switches

The steering wheel switches can be used to operate a connected cellular phone, or portable digital audio player (portable player).

Operating Bluetooth® phone using the steering wheel switches

- ① Volume
The voice guidance volume cannot be adjusted using this button.
- ② Off-hook switch
Turns the hands-free system on/
starts a call
- ③ On-hook switch
Turns the hands-free system off/
ends a call/refuses a call

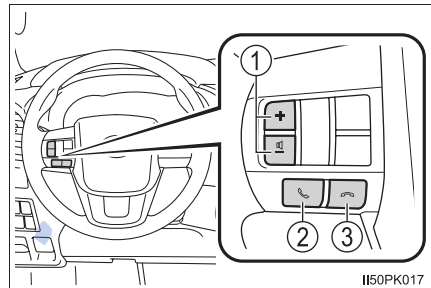

امداد خودرو فارما

تلفن شبانه روزی: ۰۲۱-۸۸۸۶۲۰۸۵

FarmaSOS.com

Registering a Bluetooth® device

Before using the Bluetooth® audio/phone, it is necessary to register a Bluetooth® device in the system. Follow the procedure below to register (pair) a device:

How to register a Bluetooth® device

- 1 Press the “SETUP ENTER” button.
- 2 Select “Bluetooth*” using the “TUNE >” or “< SELECT” button, and press the “SETUP ENTER” button.
- 3 Select “Pairing” using the “TUNE >” or “< SELECT” button, and press the “SETUP ENTER” button.

A passkey will be displayed.

- 4 SSP (Secure Simple Pairing) incompatible Bluetooth® devices:
Input the passkey into the device.
SSP (Secure Simple Pairing) compatible Bluetooth® devices:
Select “YES” to register the device. Depending on the type of device, it may register automatically.

If a Bluetooth® device has both music player and cellular phone functions, both functions will be registered at the same time. When deleting the device, both functions will be deleted at the same time.

If the off-hook switch is pressed and the “TEL” or “PHONE” mode is entered when no phones have been registered, the registration screen will be automatically displayed.

*: The Bluetooth® word mark and logos are registered trademarks owned by Bluetooth SIG, Inc.

Using the "SETUP" menu ("Bluetooth*" menu)

Registering a Bluetooth® device in the system allows the system to function. The following functions can be used for registered devices:

Functions and operation procedures

- 1 Press the "SETUP ENTER" button.
- 2 Select "Bluetooth*" using the "TUNE >" or "< SELECT" button, and press the "SETUP ENTER" button.
- 3 Select one of the following functions using the "TUNE >" or "< SELECT" button.
 - Registering a Bluetooth® device "Pairing"
 - Listing the registered cellular phones "List phone"
 - Listing the registered portable players "List audio"
 - Changing the passkey "Passkey"
 - Setting automatic connection of the device on or off "BT power"
 - Displaying the device status "Bluetooth* info"
 - Setting the automatic connection confirmation display to on or off "Display setting"
 - Initialization "Initialize"

*: The Bluetooth® word mark and logos are registered trademarks owned by Bluetooth SIG, Inc.

Registering a Bluetooth® device

Select "Pairing" using the "TUNE >" or "< SELECT" button, and press the "SETUP ENTER" button, and press (Add New).

- If a Bluetooth® device is not connected currently
Perform the procedure for registering a Bluetooth® device from step **4**. (→P. 419)
- If other Bluetooth® device is connected currently
The Bluetooth® device needs to be disconnected.
After disconnecting, perform the procedure for registering a Bluetooth® device from step **2**. (→P. 419)
- If device list is full
 - 1** Select the Bluetooth® device to be deleted using the "TUNE >" or "< SELECT" button, and press the "SETUP ENTER" button.
 - 2** Press (YES).

امداد خودرو فارما

تلفن شبانه روزی: ۰۲۱-۸۸۸۶۲۰۸۵

FarmaSOS.com

Listing the registered cellular phones

Select "List phone" using the "TUNE >" or "< SELECT" button, and press the "SETUP ENTER" button. The list of registered cellular phones will be displayed.

● Connecting the registered cellular phone to the audio system

- 1 Select the name of the cellular phone to be connected using the "TUNE >" or "< SELECT" button, and press the "SETUP ENTER" button.
- 2 Select "Select" using the "TUNE >" or "< SELECT" button, and press the "SETUP ENTER" button.

● Deleting a registered cellular phone

- 1 Select the name of the cellular phone to be deleted using the "TUNE >" or "< SELECT" button, and press the "SETUP ENTER" button.
- 2 Select "Delete" using the "TUNE >" or "< SELECT" button, and press the "SETUP ENTER" button.
- 3 Press (YES).

● Disconnecting the registered cellular phone from the audio system

- 1 Select the name of the cellular phone to be disconnected using the "TUNE >" or "< SELECT" button, and press the "SETUP ENTER" button.
- 2 Select "Disconnect" using the "TUNE >" or "< SELECT" button, and press the "SETUP ENTER" button.
- 3 Press (YES).

Listing the registered portable players

Select "List audio" using the "TUNE >" or "< SELECT" button, and press the "SETUP ENTER" button. The list of registered portable players will be displayed.

- Connecting the registered portable player to the audio system

- 1 Select the name of the portable player to be connected using the "TUNE >" or "< SELECT" button, and press the "SETUP ENTER" button.
- 2 Select "Select" using the "TUNE >" or "< SELECT" button, and press the "SETUP ENTER" button.

- Deleting the registered portable player

- 1 Select the name of the portable player to be deleted using the "TUNE >" or "< SELECT" button, and press the "SETUP ENTER" button.
- 2 Select "Delete" using the "TUNE >" or "< SELECT" button, and press the "SETUP ENTER" button.
- 3 Press (YES).



- Disconnecting the registered portable player from the audio system

- 1 Select the name of the portable player to be disconnected using the "TUNE >" or "< SELECT" button, and press the "SETUP ENTER" button.
- 2 Select "Disconnect" using the "TUNE >" or "< SELECT" button, and press the "SETUP ENTER" button.
- 3 Press (YES).

- Selecting the connection method

- 1 Select the name of the desired portable player using the "TUNE >" or "< SELECT" button, and press the "SETUP ENTER" button.
- 2 Select "Connection method" using the "TUNE >" or "< SELECT" button, and press the "SETUP ENTER" button.
- 3 Select "From vehicle" or "From audio" using the "TUNE >" or "< SELECT" button, and press the "SETUP ENTER" button.

Changing the passkey

- 1 Select "Passkey" using the "TUNE >" or "< SELECT" button, and press the "SETUP ENTER" button.
- 2 Select a 4 to 8-digit passkey using the "TUNE >", "< SELECT" and "SETUP ENTER" button.
Input the number 1 digit at a time.
- 3 When the entire number to be registered as a passkey has been input, press  (ENTER).
If the passkey to be registered has 8 digits, pressing  (ENTER) is not necessary.

Setting automatic connection of the device on or off

If "BT power" is set to on, the registered device will be connected automatically when the engine switch is turned to the "ACC" position (vehicles without smart entry & start system) or ACCESSORY mode (vehicles with smart entry & start system).

- 1 Select "BT power" using the "TUNE >" or "< SELECT" button, and press the "SETUP ENTER" button.
- 2 Select "ON" or "OFF" using the "SETUP ENTER" button.

Displaying the device status

Select "Bluetooth* info" using the "TUNE >" or "< SELECT" button, and press the "SETUP ENTER" button.

● Displaying the device name

Select "Device name" using the "TUNE >" or "< SELECT" button, and press the "SETUP ENTER" button.

● Displaying the device address

Select "Device address" using the "TUNE >" or "< SELECT" button, and press the "SETUP ENTER" button.

*: The Bluetooth® word mark and logos are registered trademarks owned by Bluetooth SIG, Inc.

Setting the automatic connection confirmation display to on or off

If the "Display setting" is set to on, the portable player connection status will be displayed when the engine switch is turned to the "ACC" position (vehicles without smart entry & start system) or ACCESSORY mode (vehicles with smart entry & start system).

- 1 Select "Display setting" using the "TUNE >" or "< SELECT" button, and press the "SETUP ENTER" button.
- 2 Select "ON" or "OFF" using the "SETUP ENTER" button.

Initialization

Select "Initialize" using the "TUNE >" or "< SELECT" button, and press the "SETUP ENTER" button.

● Initializing the sound settings

Select "Sound setting" using the "TUNE >" or "< SELECT" button and press (YES).

For details about sound settings: →P. 426

● Initializing the device information

Select "Car device info" using the "TUNE >" or "< SELECT" button and press (YES).

Automatic connection of a portable device, automatic connection confirmation display and the passkey will be initialized.

● Initializing the all settings

Select "All initialize" using the "TUNE >" or "< SELECT" button and press (YES).

■ The number of Bluetooth® device that can be registered

Up to 5 Bluetooth® device can be registered in the system.

■ Bluetooth® audio/phone system functions

Certain functions may not be available during driving.

Using the "SETUP" menu ("TEL" or "PHONE" menu)

Functions and operation procedures

To enter the menu for each function, press the "SETUP ENTER" button and follow the steps below using the "TUNE >" or "< SELECT" button:

- Adding a new phone number
 1. "TEL" or "PHONE" → 2. "Phonebook" → 3. "Add contacts"
- Setting speed dials
 1. "TEL" or "PHONE" → 2. "Phonebook" → 3. "Add SD"
- Deleting call histories
 1. "TEL" or "PHONE" → 2. "Phonebook" → 3. "Delete call history"
- Deleting a registered phone number
 1. "TEL" or "PHONE" → 2. "Phonebook" → 3. "Delete contacts"
- Deleting another cellular phone's phonebook
 1. "TEL" or "PHONE" → 2. "Phonebook" → 3. "Delete other PB"
- Setting automatic transferring of the phonebook to on or off
 1. "TEL" or "PHONE" → 2. "Auto transfer" تلفن شبانه زوری
- Setting call volume
 1. "TEL" or "PHONE" → 2. "HF sound setting" → 3. "Call volume"
- Setting ring tone volume
 1. "TEL" or "PHONE" → 2. "HF sound setting" → 3. "Ringtone volume"
- Setting ring tone
 1. "TEL" or "PHONE" → 2. "HF sound setting" → 3. "Ringtone"
- Transferring call histories
 1. "TEL" or "PHONE" → 2. "Transfer histories"

Adding a new phone number

Select "Add contacts" using the "TUNE >" or "< SELECT" button, and press the "SETUP ENTER" button.

● Transferring all contacts from the cellular phone

1 Select "Overwrite all" using the "TUNE >" or "< SELECT" button, and press the "SETUP ENTER" button.

2 Press (YES).

● Transferring one contact from the cellular phone

1 Select "Add one contact" using the "TUNE >" or "< SELECT" button, and press the "SETUP ENTER" button.

2 Press (YES).

Setting speed dials

1 Select "Add SD" using the "TUNE >" or "< SELECT" button, and press the "SETUP ENTER" button.

2 Select the desired data using the "TUNE >" or "< SELECT" button, and press the "SETUP ENTER" button.

3 Press the desired preset button (from [1] to [5]).

For details about setting speed dials from the call history: →P. 436

For details about deleting speed dials: →P. 435

Deleting call histories

Select "Delete call history" using the "TUNE >" or "< SELECT" button, and press the "SETUP ENTER" button.

● Deleting outgoing call history

- 1 Select "Outgoing calls" using the "TUNE >" or "< SELECT" button, and press the "SETUP ENTER" button.
- 2 Select the desired phone number using the "TUNE >" or "< SELECT" button, and press the "SETUP ENTER" button.
- 3 Press (YES).

To delete all outgoing call history data, press (ALL) and then press (YES).

● Deleting incoming call history

- 1 Select "Incoming calls" using the "TUNE >" or "< SELECT" button, and press the "SETUP ENTER" button.
- 2 Select the desired phone number using the "TUNE >" or "< SELECT" button, and press the "SETUP ENTER" button.
- 3 Press (YES).

To delete all incoming call history data, press (ALL) and then press (YES).

● Deleting missed call history

- 1 Select "Missed calls" using the "TUNE >" or "< SELECT" button, and press the "SETUP ENTER" button.
- 2 Select the desired phone number using the "TUNE >" or "< SELECT" button, and press the "SETUP ENTER" button.
- 3 Press (YES).

To delete all missed call history data, press (ALL) and then press (YES).

● Deleting a number from all call histories (Outgoing calls, Incoming calls and Missed calls)

- 1 Select "All calls" using the "TUNE >" or "< SELECT" button, and press the "SETUP ENTER" button.
- 2 Select the desired phone number using the "TUNE >" or "< SELECT" button, and press the "SETUP ENTER" button.
- 3 press (YES).

To delete all of the call histories data, press (ALL) and then press (YES).

تلفن شبانه روزی: ۰۲۱-۸۸۸۶۲۰۸۵

FarmaSOS.com

Deleting a registered phone number

- 1 Select "Delete contacts" using the "TUNE >" or "< SELECT" button, and press the "SETUP ENTER" button.
- 2 Select the desired phone number using the "TUNE >" or "< SELECT" button, and press the "SETUP ENTER" button.
- 3 Press (YES).

To delete all the registered phone numbers, press (ALL) and then press (YES).

Press (A-Z) to display the registered names in alphabetical order of the initial.

Deleting another cellular phone's phonebook

- 1 Select "Delete other PB" using the "TUNE >" or "< SELECT" button, and press the "SETUP ENTER" button.
- 2 Select the desired phonebook using the "TUNE >" or "< SELECT" button, and press the "SETUP ENTER" button.
- 3 Press (YES).

Setting automatic transferring of the phonebook to on or off

When the "Auto transfer" is set to on, the phone's contact data and history are automatically transferred after HFP connection is successful.

- 1 Select "Auto transfer" using the "TUNE >" or "< SELECT" button, and press the "SETUP ENTER" button.
- 2 Select "ON" or "OFF" using the "SETUP ENTER" button.

For details about PBAP (Phone Book Access Profile) Automatic Transfer: →P. 436

Setting call volume

- 1 Select "Call volume" using the "TUNE >" or "< SELECT" button, and press the "SETUP ENTER" button.
- 2 Change the call volume.
To decrease the volume: Press the "< SELECT" button.
To increase the volume: Press the "TUNE >" button.
To set the volume, press  (BACK).

Setting ring tone volume

- 1 Select "Ringtone volume" using the "TUNE >" or "< SELECT" button, and press the "SETUP ENTER" button.
- 2 Change the ring tone volume.
To decrease the volume: Press the "< SELECT" button.
To increase the volume: Press the "TUNE >" button.
To set the volume, press  (BACK).

امداد خودرو فارما

تلفن شبانه روزی: ۰۲۱-۸۸۸۶۲۰۸۵

FarmaSOS.com

Setting ring tone

- 1 Select "Ringtone" using the "TUNE >" or "< SELECT" button, and press the "SETUP ENTER" button.
- 2 Select a ring tone (1 - 3) using the "TUNE >" or "< SELECT" button, and press the "SETUP ENTER" button. To set the selected ring tone, press (BACK).

Transferring call histories

- 1 Select "Transfer histories" using the "TUNE >" or "< SELECT" button, and press the "SETUP ENTER" button.
- 2 Press (YES).

■ Phone number

Up to 1000 names can be stored.

■ Call history

Up to 10 numbers can be stored in each of the outgoing, incoming and missed call history memories.

■ Limitation of number of digits

A phone number that exceeds 24 digits cannot be registered.

■ Bluetooth® phone system functions

Certain functions may not be available during driving: تلفن

Operating a Bluetooth® enabled portable player

► Type A

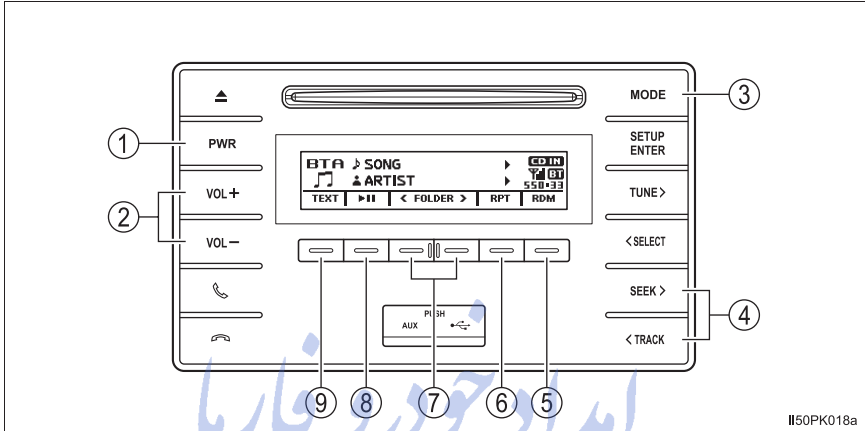

► Type B

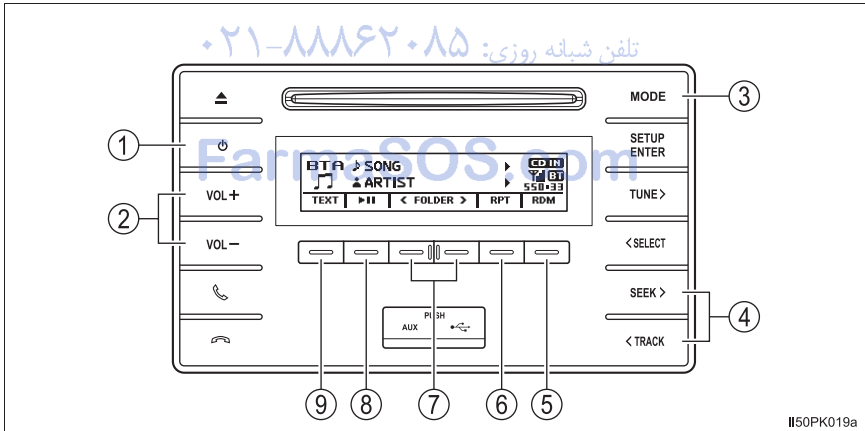

- | | |
|--|------------------------------|
| ① Power | ⑤ Random play or back button |
| ② Volume | ⑥ Repeat play |
| ③ Changing the audio source/
playback | ⑦ Selecting an album |
| ④ Selecting a track, fast-forwarding or
rewinding | ⑧ Playback/pause |
| | ⑨ Displaying text message |

Selecting an album

Press  (<FOLDER) or  (FOLDER>) to select desired album.

Selecting a track

Press the “SEEK >” or “< TRACK” button to select the desired track.

Fast-forwarding and rewinding tracks

Press and hold the “SEEK >” or “< TRACK” button.

Repeat play

Pressing  (RPT) changes modes in the following order:
Track repeat→Album repeat→Off

Random play

Pressing  (RDM) changes modes in the following order:
Album random→All track random→Off

Playing and pausing tracks

Press .

Switching the display

Press  (TEXT) to display or hide the album title.

If there are continuing texts,  is displayed.

Press and hold the button to display the remaining texts.

Bluetooth® audio system functions

Depending on the portable player that is connected to the system, certain functions may not be available.

Display



→P. 391

Making a phone call

To enter the “TEL” or “PHONE” mode, press the off-hook switch.



Dialing by selecting a name





- 1 Select “Phonebook” using the “TUNE >” or “< SELECT” button, and press the “SETUP ENTER” button.
- 2 Select the desired name using the “TUNE >” or “< SELECT” button, and press the off-hook switch.

By pressing  (Add S. Dial) and one of the speed dial buttons (from  [1] to  [5]) while the desired name is selected, it can be registered as a speed dial.

Press  (A-Z) to display the registered names in alphabetical order of the initial.

Speed dialing

- 1 Select “Speed dials” using the “TUNE >” or “< SELECT” button, and press the “SETUP ENTER” button.
- 2 Press the desired preset button (from  [1] to  [5]) and press the off-hook switch.

To delete a registered speed dial, after selecting the desired preset button (from  [1] to  [5]), press  (DELETE) and then press  (YES).

Dialing by entering the number

- 1 Select “Dial by number” using the “TUNE >” or “< SELECT” button, and press the “SETUP ENTER” button.
- 2 Enter the phone number and press the off-hook switch.

Dialing from call histories

- 1 Select “All calls”, “Missed calls”, “Incoming calls” or “Outgoing calls” using the “TUNE >” or “< SELECT” button, and press the “SETUP ENTER” button.
- 2 Select a desired number using the “TUNE >” or “< SELECT” button, and press the off-hook switch.

The following operations can be performed:

- Registering a number as a speed dial

Press (Add S. Dial) and then press the desired preset button (from [1] to [5]).

- Deleting the selected number

Press (DELETE) and press (YES).

PBAP (Phone Book Access Profile) Automatic Transfer

If your cellular phone is not PBAP (Phone Book Access Profile) compatible, the contacts cannot be transferred.

Depending on the type of Bluetooth® phone, it may be necessary to perform additional steps on the phone when transferring contact data.

- 1 Setting automatic transferring of the phonebook to on. (→P. 430)
Default setting is on.
- 2 After HFP connection is successful, the phone’s contact data and history are automatically transferred, and then “Transfer waiting” is displayed when “TEL” mode is selected.
 - If automatic transfer is successful, “Transferred” is displayed except for Power off mode.
 - If automatic transfer is failed, “Failed to transfer part of contact” or “Transfer failed” is displayed.
If phone book memory is full, “Failed to transfer part of contacts” is displayed.
 - Automatic transfer is canceled by pushing (CANCEL) or On-hook switch.
 - When “Display setting” is set to off, it doesn’t display the PBAP automatic transfer result confirmation. (→P. 425)

Receiving a phone call

Answering the phone

Press the off-hook switch.

Refusing the call

Press the on-hook switch.

Receiving a call when on another call

Press the off-hook switch.

Pressing the off-hook switch again returns you to the previous call.

Adjusting the ring tone volume when receiving a call

To decrease the volume: Press the “VOL -” button.

To increase the volume: Press the “VOL +” button.

امداد خودرو فارما
تلفن شبانه روزی: ۰۲۱-۸۸۸۶۲۰۸۵

FarmaSOS.com

Speaking on the phone

Transferring a call

A call can be transferred between the cellular phone and system while dialing, receiving a call, or during a call. Use one of the following methods:

- a. Operate the cellular phone.

Refer to the manual that comes with the cellular phone for the operation of the phone.





- b. Press the  (PHONE).*

*: This operation can be performed only when transferring a call from the cellular phone to the system during a call.

Muting your voice

Press  (MUTE).

Inputting digits

- 1 Press  (0-9).
- 2 Press the “TUNE >” or “< SELECT” button to select the number, and then press the “SETUP ENTER” button. تلفن شماره
If tone data is saved, press  (SEND) to send the data all at once.
Press  (EXIT) to delete the tone data.
- 3 When finished, press  (BACK) to return to the previous screen.

Setting call volume

To decrease the volume: Press the “VOL -” button.

To increase the volume: Press the “VOL +” button.

■ When talking on the phone

- Do not talk simultaneously with the other party.
- Keep the volume of the received voice down. Otherwise, voice echo will increase.

■ Automatic volume adjustment

When vehicle speed is 80 km/h (50 mph) or more, the volume automatically increases. The volume returns to the previous volume setting when vehicle speed drops to 70 km/h (43 mph) or less.

■ Phone call system functions

Depending on the cellular phone, certain functions may not be available.

■ Situations where the system may not recognize your voice

- When driving on a rough road
- When driving at high speeds
- When air is blowing out of the vents onto the microphone
- When the air conditioning fan emits a loud noise

امداد خودرو فارما

تلفن شبانه روزی: ۰۲۱-۸۸۸۶۲۰۸۵

FarmaSOS.com

Bluetooth®

■ Conditions affecting operation

The Bluetooth® audio/phone may not operate normally in the following situations:

- The portable player does not support Bluetooth®
- The cellular phone is located outside the service area
- The Bluetooth® device is switched off
- The Bluetooth® device has a low battery
- The Bluetooth® device is not connected to the system
- The Bluetooth® device is behind the seat or in the glove box or console box, or metal material covers or touches the device

■ When transferring ownership of the vehicle

Be sure to initialize the system to prevent personal data from being improperly accessed. (→P. 425)

■ About Bluetooth®

The Bluetooth® word mark and logos are registered trademarks owned by Bluetooth SIG, Inc. and any use of such marks by FUJITSU TEN LIMITED is under license. Other trademarks and trade names are those of their respective owners.

The Bluetooth® word mark and logos are registered trademarks owned by Bluetooth SIG, Inc. and any use of such marks by PIONEER CORPORATION is under license. Other trademarks and trade names are those of their respective owners.



■ Compatible models

- Bluetooth® specifications:
Ver. 1.1, or higher (Recommended: Ver. 2.1 + EDR or higher)
- Following Profiles:
 - A2DP (Advanced Audio Distribution Profile) Ver. 1.0 or higher (recommended: Ver. 1.2 or higher)
 - AVRCP (Audio/Video Remote Control Profile) Ver. 1.0 or higher (recommended: Ver. 1.3 or higher)

Portable players must correspond to the above specifications in order to be connected to the Bluetooth® audio/phone. However, please note that some functions may be limited depending on the type of portable player.

- Cellular phone
 - HFP (Hands Free Profile) Ver. 1.0 or higher (Recommended: Ver. 1.5)
 - OPP (Object Push Profile) Ver. 1.1
 - PBAP (Phone Book Access Profile) Ver. 1.0

امداد خودرو فارما

تلفن شبانه روزی: ۰۲۱-۸۸۸۶۲۰۸۵

FarmaSOS.com

■ Certification

Declaration of Conformity with regard to the R&TTE Directive 1999/5/EC

Manufacturer:

PIONEER CORPORATION

1-1, Shin-ogura, Saiwai-ku, Kawasaki-shi,
Kanagawa 212-0031, JAPAN

EU Representative's:

Pioneer Europe NV

Haven 1087, Keetberglaan 1,
B-9120 Melsele, Belgium/Belgique
<http://www.pioneer.eu>



[*] DEH-8158, DEH-8258, DEH-8258ZT02

Български

С настоящето, PIONEER, декларира, че този [*] отговаря на основните изисквания и други съответни постановления на Директивата 1999/5/EC.

Čeština

PIONEER tímto prohlašuje, že tento [*] je ve shodě se základními požadavky a dalšími příslušnými ustanoveními směrnice 1999/5/ES.

Dansk

Undertegnede PIONEER erklærer herved, at følgende udstyr [*] overholder de væsentlige krav og øvrige relevante krav i direktiv 1999/5/EF.

Nederlands

Hierbij verklaart PIONEER dat het toestel [*] in overeenstemming is met de essentiële eisen en de andere relevante bepalingen van richtlijn 1999/5/EG.

English

Hereby, PIONEER, declares that this [*] is in compliance with the essential requirements and other relevant provisions of Directive 1999/5/EC.

Eesti

Käesolevaga kinnitab PIONEER sadame [*] vastavust direktiivi 1999/5/EÜ põhinõuetele ja nimetatud direktiivist tulenevatele teistele asjakohastele sätetele.

Suomi

PIONEER vakuuttaa täten että [*] tyyppinen laite on direktiivin 1999/5/EY oleellisten vaatimusten ja sitä koskevien direktiivin muiden ehtojen mukainen.

Français

Par la présente PIONEER déclare que l'appareil [*] est conforme aux exigences essentielles et aux autres dispositions pertinentes de la directive 1999/5/CE.

Deutsch

Hiermit erkläre PIONEER, dass sich dieses [*] in Übereinstimmung mit den grundlegenden Anforderungen und den anderen relevanten Vorschriften der Richtlinie 1999/5/EG befindet. (BMW)

ελληνικά

ΜΕ ΤΗΝ ΠΑΡΟΥΣΑ ΠΙΟΝΕΕΡ ΔΗΛΩΝΕΙ ΟΤΙ [*] ΣΥΜΜΟΡΦΩΝΕΤΑΙ ΠΡΟΣ ΤΙΣ ΟΥΣΙΩΔΕΙΣ ΑΠΑΙΤΗΣΕΙΣ ΚΑΙ ΤΙΣ ΛΟΙΠΕΣ ΣΧΕΤΙΚΕΣ ΔΙΑΤΑΞΕΙΣ ΤΗΣ ΟΔΗΓΙΑΣ 1999/5/ΕΚ.

Magyar

Alulírott, PIONEER nyilatkozik, hogy a [*] megfelel a vonatkozó alapvető követelményeknek és az 1999/5/EC irányelv egyéb előírásainak.

Italiano

Con la presente PIONEER dichiara che questo [*] è conforme ai requisiti essenziali ed alle altre disposizioni pertinenti stabilite dalla direttiva 1999/5/CE.

Latviešu valoda

Ar šo PIONEER deklarē, ka [*] atbilst Direktīvas 1999/5/EK būtiskajām prasībām un citiem ar to saistītajiem noteikumiem.

Lietuvių kalba

Šiuo PIONEER deklaruojama, kad šis [*] atitinka esminius reikalavimus ir kitas 1999/5/EB Direktyvos nuostatas.

Malti

Hawnhekk, PIONEER, jidkijara li dan [*] jikkonforma mal-Nijjiet essenzjali u ma provvedimenti oħrajn relevanti li hemm fid-Direttiva 1999/5/EC.

Polski

Niniejszym PIONEER oświadcza, że [*] jest zgodny z zasadniczymi wymogami oraz pozostałymi stosownymi postanowieniami Dyrektywy 1999/5/EC.

Português

PIONEER declara que este [*] está conforme com os requisitos essenciais e outras disposições da Directiva 1999/5/CE.

Română

Prin prezenta, PIONEER, declara ca acest [*] este in conformitate cu cerintele esentiale si alte prevederi ale Directivei 1999/5/EC.

Slovenčina

PIONEER týmto vyhlasuje, že [*] spĺňa základné požiadavky a všetky príslušné ustanovenia Smernice 1999/5/ES.

Slovenščina

PIONEER izjavlja, da je ta [*] v skladu z bistvenimi zahtevami in ostalimi relevantnimi določili direktive 1999/5/ES.

Español

Por medio de la presente PIONEER declara que el [*] cumple con los requisitos esenciales y cualesquiera otras disposiciones aplicables o exigibles de la Directiva 1999/5/CE.

Svenska

Härmed intygar PIONEER att denna [*] står i överensstämmelse med de väsentliga egenskapskrav och övriga relevanta bestämmelser som framgår av direktiv 1999/5/EG.

Íslenska

Hér með lýsir PIONEER yfir því að [*] er í samræmi við grunnkröfur og aðrar kröfur, sem gerðar eru í tilskipun 1999/5/EC.

Norsk

PIONEER erklærer herved at utstyret [*] er i samsvar med de grunnleggende krav og øvrige relevante krav i direktiv 1999/5/EF.

Црногорски језик

Ovim, PIONEER, izjaviljuje da ova [*] je usklađena sa bitnim zahtjevima i drugim relevantnim odredbama Direktive 1999/5/EC.

Shqip

Nepërmjet kësaj, PIONEER, deklaronë që ky [*] është në pajtim me kërkesat thelbësore dhe dispozitat e tjera përkatëse të Direktivës 1999/5/EC.

Hrvatski

Ovime tvrtka Pioneer izjaviljuje da je [*] u skladu osnovnim zahtjevima i ostalim odredbama Direktive 1999/5/EC.

Српски

Ovim, PIONEER, deklarise da je [*] u skladu sa osnovnim zahtevima i ostalim relevantnim odredbama Direktive 1999/5/EC.

Bosanski

PIONEER ovim izjaviljuje da je [*] u skladu sa osnovnim zahtjevima i drugim relevantnim odredbama Direktive 1999/5/EC.

Македонски

Со ова, PIONEER изјавува дека овој [*] е во согласност со основните барања и други релевантни одредби од Директивата 1999/5/EC.

Türkçe

Bu vesile ile, PIONEER, bu [*] için 1999/5/EC Direktifinin esas şartları ve diğer ilgili hükümlerine uygunluğunu beyan eder.

FCC ID: BABFT0052A

CAUTION: Radio Frequency Radiation Exposure

This equipment complies with FCC radiation exposure limits set forth for uncontrolled equipment and meets the FCC radio frequency (RF) Exposure Guidelines. This equipment has very low levels of RF energy that it deemed to comply without maximum permissive exposure evaluation (MPE). But it is desirable that it should be installed and operated with at least 20cm and more between the radiator and person's body in normal use position.

Co-location: This transmitter must not be co-located or operated in conjunction with any other antenna or transmitter.

This device complies with part 15 of the FCC Rules. Operation is subject to the following two conditions: (1) This device may not cause harmful interference, and (2) this device must accept any interference received, including interference that may cause undesired operation.

FCC WARNING

Changes or modifications not expressly approved by the party responsible for compliance could void the user's authority to operate the equipment.



امداد خودرو فارما

The latest "DECLARATION of CONFORMITY" (DoC) is available at the following:

DoC address:

FUJITSU TEN LIMITED - تلفن شبانه روزی: ۸۸۸۶۲۰۸۵

2-28, Goshō-dori 1-chome, Hyogo-ku, Kobe, 652-8510, Japan

FarmaSOS.com

<p>С настоящето, FUJITSU TEN LIMITED, декларира, че FT0052B е в съответствие със съществените изисквания и другите приложими разпоредби на Директива 1999/5/EC.</p>
<p>FUJITSU TEN LIMITED tímto prohlašuje, že tento FT0052B je ve shodě se základními požadavky a dalšími příslušnými ustanoveními směrnice 1999/5/ES.</p>
<p>Ovim FUJITSU TEN LIMITED, izjavljuje da je FT0052B u skladu s bitnim zahtjevima drugim relevantnim odredbama Direktive 1999/5/EC.</p>
<p>Undertegnede FUJITSU TEN LIMITED erklærer herved, at følgende udstyr FT0052B overholder de væsentlige krav og øvrige relevante krav i direktiv 1999/5/EF.</p>
<p>Hiermit erklärt FUJITSU TEN LIMITED, dass sich das Gerät FT0052B in Übereinstimmung mit den grundlegenden Anforderungen und den übrigen einschlägigen Bestimmungen der Richtlinie 1999/5/EG befindet.</p>
<p>Käesolevaga kinnitab FUJITSU TEN LIMITED seadme FT0052B vastavust direktiivi 1999/5/EÜ põhinõuetele ja nimetatud direktiivist tulenevatele teistele asjakohastele sätetele.</p>
<p>Hereby, FUJITSU TEN LIMITED, declares that this FT0052B is in compliance with the essential requirements and other relevant provisions of Directive 1999/5/EC.</p>
<p>Por medio de la presente FUJITSU TEN LIMITED declara que el FT0052B cumple con los requisitos esenciales y cualesquiera otras disposiciones aplicables o exigibles de la Directiva 1999/5/CE.</p>
<p>ΜΕ ΤΗΝ ΠΑΡΟΥΣΑ FUJITSU TEN LIMITED ΔΗΛΩΝΕΙ ΟΤΙ FT0052B ΣΥΜΜΟΡΦΩΝΕΤΑΙ ΠΡΟΣ ΤΙΣ ΟΥΣΙΩΔΕΙΣ ΑΠΑΙΤΗΣΕΙΣ ΚΑΙ ΤΙΣ ΛΟΙΠΕΣ ΣΧΕΤΙΚΕΣ ΔΙΑΤΑΞΕΙΣ ΤΗΣ ΟΔΗΓΙΑΣ 1999/5/ΕΚ.</p>
<p>Par la présente FUJITSU TEN LIMITED déclare que l'appareil FT0052B est conforme aux exigences essentielles et aux autres dispositions pertinentes de la directive 1999/5/CE.</p>
<p>Con la presente FUJITSU TEN LIMITED dichiara che questo FT0052B è conforme ai requisiti essenziali ed alle altre disposizioni pertinenti stabilite dalla direttiva 1999/5/CE.</p>
<p>Ar šo FUJITSU TEN LIMITED deklarē, ka FT0052B atbilst Direktīvas 1999/5/EK būtiskajām prasībām un citiem ar to saistītajiem noteikumiem.</p>
<p>Šiuo FUJITSU TEN LIMITED deklaruoja, kad šis FT0052B atitinka esminius reikalavimus ir kitas 1999/5/EB Direktyvos nuostatas.</p>
<p>Hierbij verklaart FUJITSU TEN LIMITED dat het toestel FT0052B in overeenstemming is met de essentiële eisen en de andere relevante bepalingen van richtlijn 1999/5/EG.</p>

Hawnhekk, FUJITSU TEN LIMITED, jiddikjara li dan FT0052B jikkonforma mal-htigijiet essenzjali u ma provvedimenti oħrajn relevanti li hemm fid-Dirrettiva 1999/5/EC.
Alulírótt, FUJITSU TEN LIMITED nyilatkozom, hogy a FT0052B megfelel a vonatkozó alapvető követelményeknek és az 1999/5/EC irányelv egyéb előírásainak.
Niniejszym FUJITSU TEN LIMITED oświadcza, że FT0052B jest zgodny z zasadniczymi wymogami oraz pozostałymi stosownymi postanowieniami Dyrektywy 1999/5/EC.
FUJITSU TEN LIMITED declara que este FT0052B está conforme com os requisitos essenciais e outras disposições da Directiva 1999/5/CE.
Prin prezenta, FUJITSU TEN LIMITED, declară că aparatul FT0052B este în conformitate cu cerințele esențiale și cu alte prevederi pertinente ale Directivei 1999/5/CE.
FUJITSU TEN LIMITED izjavlja, da je ta FT0052B v skladu z bistvenimi zahtevami in ostalimi relevantnimi določili direktive 1999/5/ES.
FUJITSU TEN LIMITED tímto vyhlasuje, že FT0052B splňa základné požiadavky a všetky príslušné ustanovenia Smernice 1999/5/ES.
FUJITSU TEN LIMITED vakuuttaa täten että FT0052B tyyppinen laite on direktiivin 1999/5/EY oleellisten vaatimusten ja sitä koskevien direktiivin muiden ehtojen mukainen.
Härmed intygar FUJITSU TEN LIMITED att denna FT0052B står i överensstämmelse med de väsentliga egenskapskrav och övriga relevanta bestämmelser som framgår av direktiv 1999/5/EG.
Hér með lýsir FUJITSU TEN LIMITED yfir því að FT0052B er í samræmi við grunnkröfur og aðrar kröfur, sem gerðar eru í tilskipun 1999/5/EC.
FUJITSU TEN LIMITED erklærer herved at utstyret FT0052B er i samsvar med de grunnleggende krav og øvrige relevante krav i direktiv 1999/5/EF.
Ovim , FUJITSU TEN LIMITED, izjavluje da ovaj FT0052B je usklađen sa bitnim zahtjevima i drugim relevantnim odredbama Direktive 1999/5/EC.
Nepermjet kesaj, FUJITSU TEN LIMITED, deklaraj qe ky FT0052B eshte ne pajtim me kerkesat thelbesore dhe dispozitat e tjera perkatese te Direktives 1999/5/EC.
İşbu belge ile FUJITSU TEN LIMITED, bu FT0052B in 1995/5/EC Yönetmeliği esas gereksinimlerine ve diğer şartlarına uygun olduğunu beyan eder.

**WARNING****■ While driving**

Do not use the portable audio player or connect the Bluetooth® system.

■ Caution regarding interference with electronic devices

- Your audio unit is fitted with Bluetooth® antennas. People with implantable cardiac pacemakers, cardiac resynchronization therapy-pacemakers or implantable cardioverter defibrillators should maintain a reasonable distance between themselves and the Bluetooth® antennas. The radio waves may affect the operation of such devices.
- Before using Bluetooth® devices, users of any electrical medical device other than implantable cardiac pacemakers, cardiac resynchronization therapy-pacemakers or implantable cardioverter defibrillators should consult the manufacturer of the device for information about its operation under the influence of radio waves. Radio waves could have unexpected effects on the operation of such medical devices.

**NOTICE****■ To prevent damage to portable players**

Do not leave portable players in the vehicle. The temperature inside the vehicle may become high, resulting in damage to the player.

امداد خودرو فارما
تلفن شبانه روزی: +۲۱-۸۸۸۶۲۰۸۵

FarmaSOS.com

Interior features

6

6-1. Using the air conditioning system and defogger

Manual air conditioning system	448
Automatic air conditioning system	456
Seat heaters	465

6-2. Using the interior lights

Interior lights list.....	466
• Personal/interior light main switch.....	467
• Personal/interior lights	467
• Interior light.....	467

6-3. Using the storage features

List of storage features	469
• Glove box	470
• Console box	470
• Cup holders	471
• Bottle holders	472
• Auxilliary boxes	473

Luggage compartment features.....	476
-----------------------------------	-----

6-4. Using the other interior features

Other interior features.....	477
• Sun visors.....	477
• Vanity mirror	477
• Clock	478
• Power outlets.....	479
• Grocery bag hooks	481
• Coat hooks	482
• Armrest.....	482
ERA-GLONASS.....	483

Manual air conditioning system*

Air conditioning controls

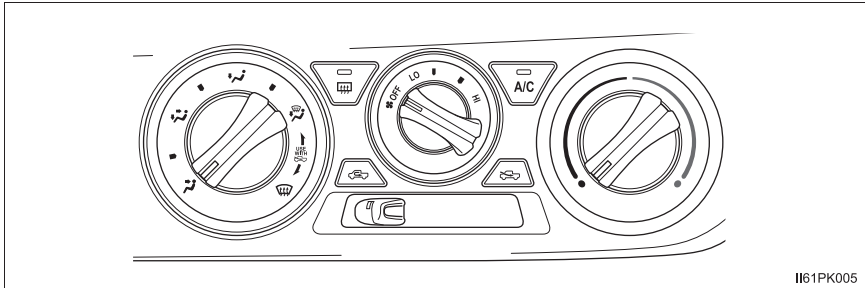



■ Adjusting the fan speed setting

Turn  clockwise (increase) or counterclockwise (decrease).

Turning the dial to "OFF" turns off the fan.

■ Adjusting the temperature setting

Turn  clockwise (warm) or counterclockwise (cool).

If  (if equipped) is not pressed, the system will blow ambient temperature air or heated air.

■ Changing the air flow mode

Set  to the desired position.



The positions between the air outlet selections can also be selected for more delicate adjustment.

*: If equipped

Other functions

■ Switching between outside air and recirculated air modes

Move the outside/recirculated air mode lever.



The mode switches between  (introduces air from outside the vehicle) and  (recycles air inside the vehicle) each time the lever is moved.

■ Defogging the windshield (vehicles with)

- 1 Set  to  position.

Set the outside/recirculated air mode lever to outside air mode if recirculated air mode is used.

- 2 Perform the following operations accordingly:

- To adjust the fan speed, turn .
- To adjust the temperature setting, turn .
- If the dehumidification function is not operating, press  to operate the dehumidification function.

To defog the windshield and the side windows early, turn the air flow and temperature up.

■ Defogging the rear window and outside rear view mirrors (if equipped)

Defoggers are used to defog the rear window, and to remove raindrops, dew and frost from the outside rear view mirrors.

Press 

■ Heater idle up (if equipped)

This feature is used to heat the engine coolant, speed up warming of the cab in cold weather, and keep the cab warm when the vehicle is not moving.

Press the switch to turn the heater idle up on/off.

If you do not turn the switch to off, the engine speed may be increased when the engine is started.

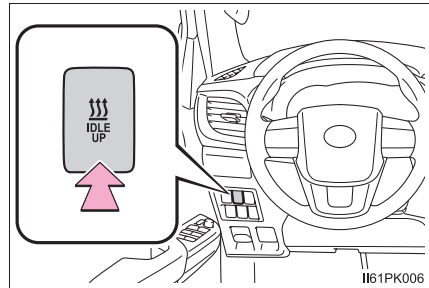
**■ Power heater (if equipped)**

This feature is used to heat the engine coolant, speed up warming of the cab in cold weather, and keep the cab warm.

Press the switch to turn the power heater on/off.

If you do not turn the switch to off, the engine speed may be increased when the engine is started.

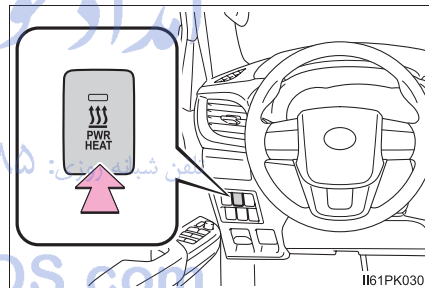

Air outlets

■ Location of air outlets

The air outlets and air volume changes according to the selected air flow mode.

← : Some models

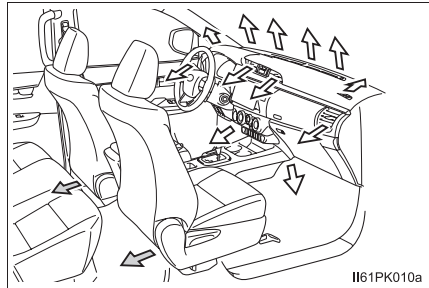

■ Adjusting the position of and opening and closing the air outlets

► Center outlets

- ① Direct air flow to the left or right, up or down.
- ② Close the vents.

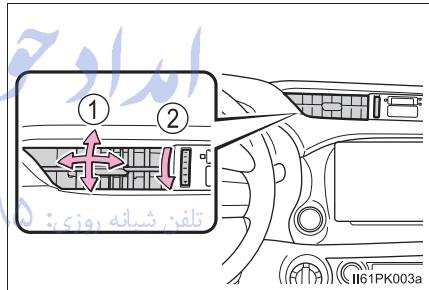

► Side outlets

- ① Direct air flow to the left or right, up or down.
- ② Close the vents.

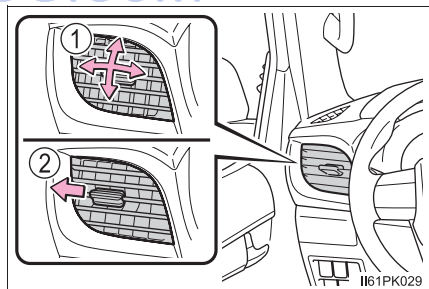

■ Fogging up of the windows

- The windows will easily fog up when the humidity in the vehicle is high.

Turning  (if equipped) on will dehumidify the air from the outlets and defog the windshield effectively.

- If you turn  (if equipped) off, the windows may fog up more easily.
- The windows may fog up if the recirculated air mode is used.

■ Outside/recirculated air mode

When driving on dusty roads such as tunnels or in heavy traffic, set the outside/recirculated air mode lever to . This is effective in preventing outside air from entering the vehicle interior. During cooling operation, setting the recirculated air mode will also cool the vehicle interior effectively.

■ When the outside temperature falls to nearly 0°C (32°F) (vehicles with



The dehumidification function may not operate even when  is pressed.

■ Ventilation and air conditioning odors

- To let fresh air in, set the air conditioning system to the outside air mode.
- During use, various odors from inside and outside the vehicle may enter into and accumulate in the air conditioning system. This may then cause odor to be emitted from the vents.
- To reduce potential odors from occurring:

It is recommended that the air conditioning system be set to outside air mode prior to turning the vehicle off.

■ **Air conditioning system operations when the engine is stopped due to the Stop & Start system (vehicles with Stop & Start system)**

When the engine is stopped due to Stop & Start system operations, the manual air conditioning cooling, heating and dehumidification functions turn off. To stop the air conditioning system from turning off, press the Stop & Start cancel switch and refrain from using the Stop & Start system.

■ **An odor comes from the air conditioning system due to the Stop & Start system operation (vehicles with Stop & Start system)**

When the engine is stopped due to Stop & Start system operations, an odor caused by moisture may be detected. This does not indicate a malfunction.

■ **Air conditioning filter**

→P. 530

امداد خودرو فارما

تلفن شبانه روزی: ۰۲۱-۸۸۸۶۲۰۸۵

FarmaSOS.com

■ **Air conditioning refrigerant (vehicles with )**

Type: R-134a (HFC-134a)



Capacity: 0.50 ± 0.05 kg (1.10 ± 0.11 lb.)

GWP (Global Warming Potential): 1430

CO2 equivalent: 0.72 t (1587.33 lb.)

Contains fluorinated greenhouse gases
Съдържа флуорсъдържащи парникови газове
Sadržava fluorirane stakleničke plinove
Obsahuje fluorované skleníkové plyny
Inneholder fluorholdige drivhusgasser
Bevat gefluoreerde broeikasgassen
Sisaldab fluoritud kasvuhoonegaase
Sisältää fluorattuja kasvihuonekaasuja
Contient des gaz à effet de serre fluorés
Enthält fluorierte Treibhausgase
Περιέχει φθοριούχα αέρια του θερμοκηπίου
Fluortartalmú üvegházhatású gázokat tartalmaz
Contiene gas fluorurati a effetto serra
Sudėtyje yra fluorintų šiltnamio efekta sukeliančių dujų
Satur fluorētas siltumnīcefekta gāzes
Fih fluorinated greenhouse gases
Zawiera fluorowane gazy cieplarniane
Contém gases fluorados com efeito de estufa
Contține gaze fluorurate cu efect de seră
Obsahuje fluórované skleníkové plyny
Vsebuje fluorirane toplogredne pline
Contiene gases fluorados de efecto invernadero
Innehåller fluorerade växthusgaser
Inneholder fluorholdige drivhusgasser
Inniheldur flúraðar gróðurhúsalofttegundir

 **WARNING**
■ To prevent the windshield from fogging up

- Do not set  to  during cool air operation in extremely humid weather. The difference between the temperature of the outside air and that of the windshield can cause the outer surface of the windshield to fog up, blocking your vision.
- Do not place anything on the instrument panel which may cover the air outlets. Otherwise, air flow may be obstructed, preventing the windshield defoggers from defogging.

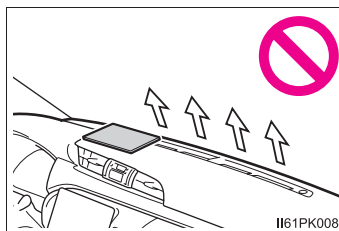
■ To prevent burns (vehicles with outside rear view mirror defoggers)

Do not touch the rear view mirror surfaces when the outside rear view mirror defoggers are on.

 **NOTICE**
■ To prevent battery discharge

Do not leave the air conditioning system on longer than necessary when the engine is not running.

FarmaSOS.com

Automatic air conditioning system*

Air outlets and fan speed are automatically adjusted according to the temperature setting.

Air conditioning controls

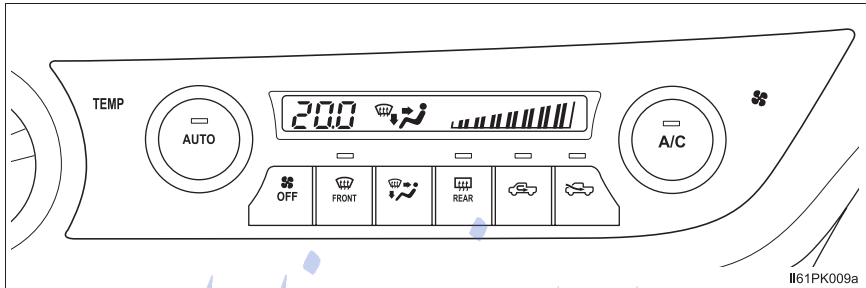

This illustration is for a left-hand drive vehicle. Some button positions differ for right-hand drive vehicles.

■ Adjusting the fan speed setting

Turn  clockwise (increase) or counterclockwise (decrease).

Press  to turn the fan off.

■ Adjusting the temperature setting

Turn  clockwise (warm) or counterclockwise (cool).

If  is not pressed, the system will blow ambient temperature air or heated air.

*: If equipped

■ Changing the air flow mode

Press  to change the air outlets.

The air outlets used are switched each time the button is pressed.

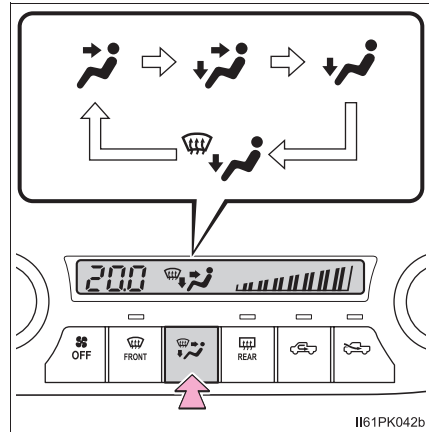

Using automatic mode

- 1 Press .

The dehumidification function begins to operate. Air outlets and fan speed are automatically adjusted according to the temperature setting.

- 2 Turn  clockwise (warm) or counterclockwise (cool) to adjust the temperature.



To stop the operation, press .

■ Automatic mode indicator

If the fan speed setting or air flow modes are operated, the automatic mode indicator goes off. However, automatic mode for functions other than that operated is maintained.

Other functions

■ Switching between outside air and recirculated air modes

Press  to switch to recirculated air mode and press  to switch to outside air mode.

■ Defogging the windshield

Press  .

The dehumidification function operates and fan speed increases.

Press  if the recirculated air mode is used. (It may switch automatically.)

To defog the windshield and the side windows early, turn the air flow and temperature up.

To return to the previous mode, press  again when the windshield is defogged.

■ Defogging the rear window and outside rear view mirrors (if equipped)

Defoggers are used to defog the rear window, and to remove rain-drops, dew and frost from the outside rear view mirrors.

▶ Vehicles without outside rear view mirror defoggers

Press  FarmaSOS.com

The defoggers will automatically turn off after approximately 15 minutes.

▶ Vehicles with outside rear view mirror defoggers

Press 

The defoggers will automatically turn off after approximately 15 minutes.

■ Power heater (if equipped)

This feature is used to heat the engine coolant, speed up warming of the cab in cold weather, and keep the cab warm.

Press the switch to turn the power heater on/off

If you do not turn the switch to off, the engine speed may be increased when the engine is started.

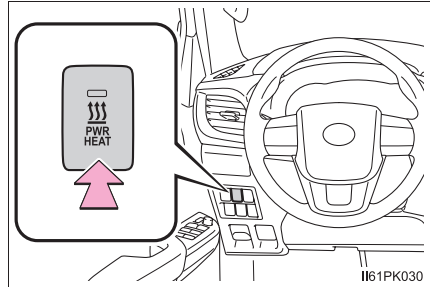

Air outlets

■ Location of air outlets

The air outlets and air volume changes according to the selected air flow mode.

← : Some models

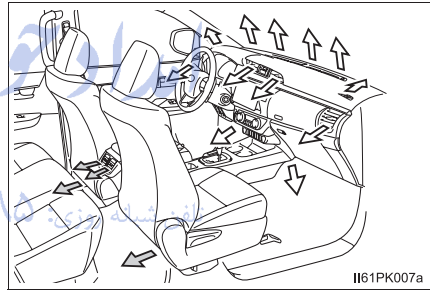

■ Adjusting the position of and opening and closing the air outlets

► Center outlets

- ① Direct air flow to the left or right, up or down.
- ② Close the vents.

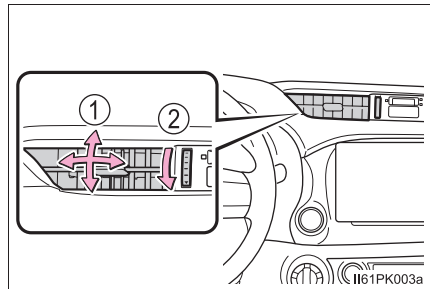

▶ Side outlets

- ① Direct air flow to the left or right, up or down.
- ② Close the vents.

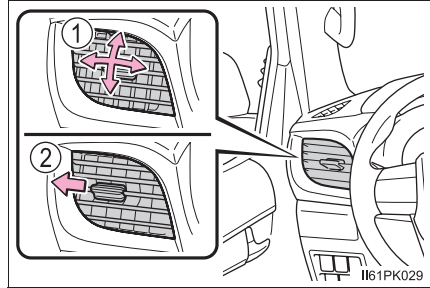

▶ Rear outlets

- ① Direct air flow to the left or right, up or down.
- ② Close the vents.

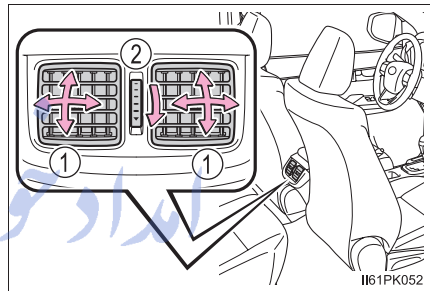

■ Using automatic mode

Fan speed is adjusted automatically according to the temperature setting and the ambient conditions.

Therefore, the fan may stop for a while until warm or cool air is ready to flow immediately after  is pressed.

■ Fogging up of the windows

- The windows will easily fog up when the humidity in the vehicle is high.

Turning  on will dehumidify the air from the outlets and defog the windshield effectively.

- If you turn  off, the windows may fog up more easily.
- The windows may fog up if the recirculated air mode is used.

■ Outside/recirculated air mode

- When driving on dusty roads such as tunnels or in heavy traffic, press  . This is effective in preventing outside air from entering the vehicle interior. During cooling operation, setting the recirculated air mode will also cool the vehicle interior effectively.
- Outside/recirculated air mode may automatically switch depending on the temperature setting or the inside temperature.

■ Operation of the air conditioning system in Eco drive mode (if equipped)

- In Eco drive mode, the air conditioning system is controlled as follows to prioritize fuel efficiency:
 - Engine speed and compressor operation controlled to restrict heating/cooling capacity
 - Fan speed restricted when automatic mode is selected
- To improve air conditioning performance, perform the following operations.
 - Adjust the fan speed
 - Turn off Eco drive mode
 - Adjust the temperature setting

■ When the outside temperature falls to nearly 0°C (32°F)

The dehumidification function may not operate even when  is pressed.

■ Ventilation and air conditioning odors

- To let fresh air in, set the air conditioning system to the outside air mode.
- During use, various odors from inside and outside the vehicle may enter into and accumulate in the air conditioning system. This may then cause odor to be emitted from the vents.
- To reduce potential odors from occurring:
 - It is recommended that the air conditioning system be set to outside air mode prior to turning the vehicle off.
 - For some models: The start timing of the blower may be delayed for a short period of time immediately after the air conditioning system is started in automatic mode.

■ Air conditioning system operations when the engine is stopped due to the Stop & Start system (vehicles with Stop & Start system)

When the engine is stopped due to Stop & Start system operations, the automatic air conditioning cooling, heating and dehumidification functions turn off and the fan speed is decreased according to the outside temperature etc. or air blowing stops. To stop the air conditioning system from turning off, press the Stop & Start cancel switch and refrain from using the Stop & Start system.

■ **An odor comes from the air conditioning system due to the Stop & Start system operation (vehicles with Stop & Start system)**

When the engine is stopped due to Stop & Start system operations, an odor caused by moisture may be detected. This does not indicate a malfunction.

■ **Air conditioning filter**

→P. 530

امداد خودرو فارما

تلفن شبانه روزی: ۰۲۱-۸۸۸۶۲۰۸۵

FarmaSOS.com

■ Air conditioning refrigerant

Type: R-134a (HFC-134a)

Capacity: 0.50 ± 0.05 kg (1.10 ± 0.11 lb.)

GWP (Global Warming Potential): 1430

CO2 equivalent: 0.72 t (1587.33 lb.)

Contains fluorinated greenhouse gases
Съдържа флуорсъдържащи парникови газове
Sadržava fluorirane stakleničke plinove
Obsahuje fluorované skleníkové plyny
Inneholder fluorholdige drivhusgasser
Bevat gefluoreerde broeikasgassen
Sisaldab fluoritud kasvuhoonegaase
Sisältää fluorattuja kasvihuonekaasuja
Contient des gaz à effet de serre fluorés
Enthält fluorierte Treibhausgase
Περιέχει φθοριούχα αέρια του θερμοκηπίου
Fluortartalmú üvegházhatású gázokat tartalmaz
Contiene gas fluorurati a effetto serra
Sudėtyje yra fluorintų šiltnamio efekta sukeliančių dujų
Satur fluorētas siltumnīcefekta gāzes
Fih fluorinated greenhouse gases
Zawiera fluorowane gazy cieplarniane
Contém gases fluorados com efeito de estufa
Conține gaze fluorurate cu efect de seră
Obsahuje fluórované skleníkové plyny
Vsebuje fluorirane toplogredne pline
Contiene gases fluorados de efecto invernadero
Innehåller fluorerade växthusgaser
Inneholder fluorholdige drivhusgasser
Inniheldur flúraðar gróðurhúsalofttegundir

 **WARNING**

■ **To prevent the windshield from fogging up**

- Do not use  during cool air operation in extremely humid weather. The difference between the temperature of the outside air and that of the windshield can cause the outer surface of the windshield to fog up, blocking your vision.
- Do not place anything on the instrument panel which may cover the air outlets. Otherwise, air flow may be obstructed, preventing the windshield defoggers from defogging.

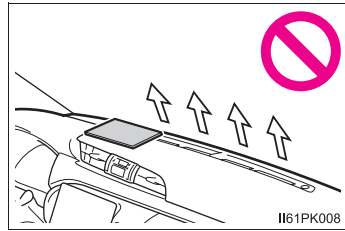

■ **To prevent burns (vehicles with outside rear view mirror defoggers)**

Do not touch the rear view mirror surfaces when the outside rear view mirror defoggers are on.

 **NOTICE**

■ **To prevent battery discharge**

Do not leave the air conditioning system on longer than necessary when the engine is not running.

Seat heaters*

- ① Turns on the front left seat heater
The indicator light comes on.
- ② Turns on the front right seat heater
The indicator light comes on.

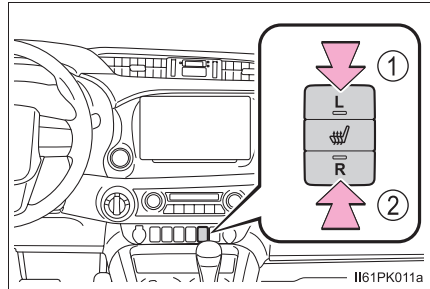

- The seat heaters can be used when the engine switch is in the "ON" position (vehicles without smart entry & start system) or IGNITION ON mode (vehicles with smart entry & start system).
- When not in use, press the seat heater switch to turn the seat heater off. The indicator light turns off.

⚠ WARNING

- Care should be taken to prevent injury if anyone in the following categories comes in contact with the seats when the heater is on:
 - Babies, small children, the elderly, the sick and the physically challenged
 - Persons with sensitive skin
 - Persons who are fatigued
 - Persons who have taken alcohol or drugs that induce sleep (sleeping drugs, cold remedies, etc.)
- Observe the following precautions to prevent minor burns or overheating:
 - Do not cover the seat with a blanket or cushion when using the seat heater.
 - Do not use seat heater more than necessary.

⚠ NOTICE

- Do not put heavy objects that have an uneven surface on the seat and do not stick sharp objects (needles, nails, etc.) into the seat.
- To prevent battery discharge, do not use the functions when the engine is not running.

*: If equipped

Interior lights list

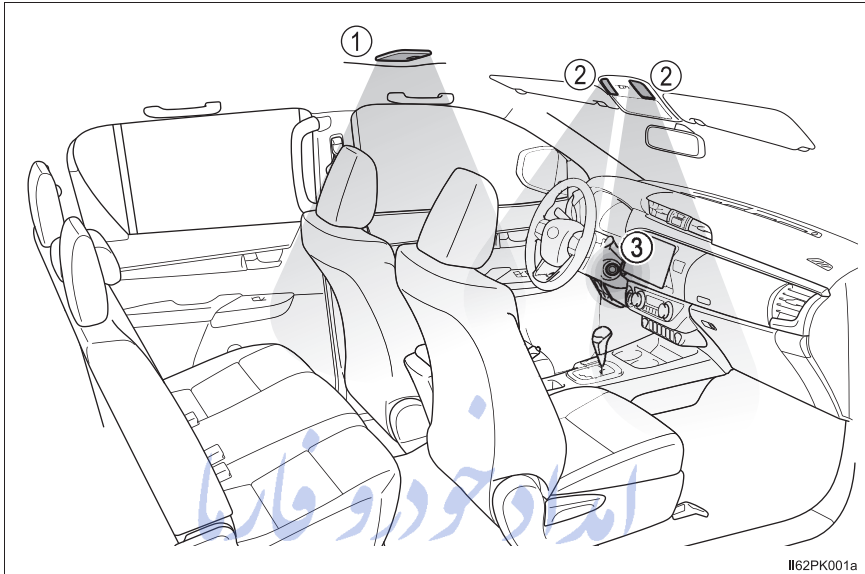

- ① Interior light (if equipped) (→P. 467)
- ② Personal/interior lights (→P. 467) تلفن شبانه روزی: ۰۲۱-۸۸۸۸۸۸۸۵
- ③ Engine switch light (if equipped)

FarmaSOS.com

Personal/interior light main switch

① Door position

The personal/interior lights come on when a door is opened. They turn off when the doors are closed.

② Off

The personal/interior lights can be individually turned on or off.

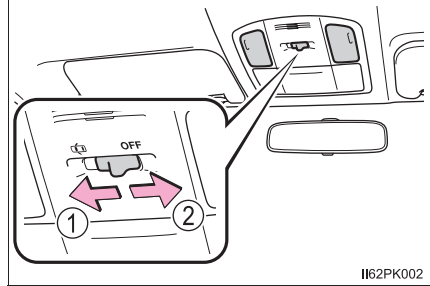

II62PK002

Personal/interior lights

On/off

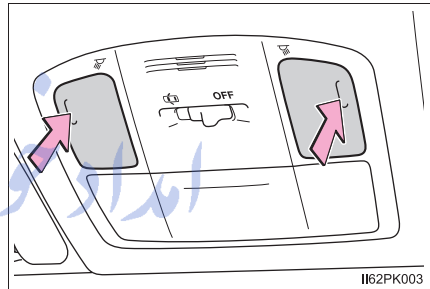

II62PK003

Interior light (if equipped)

① Off

② Door position

The interior light comes on when a door is opened. It turns off when the doors are closed.

③ On

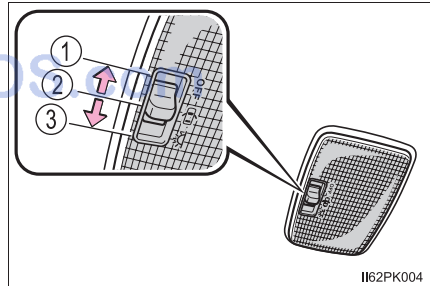

II62PK004

- Illuminated entry system (if equipped):

- ▶ Vehicles without smart entry & start system

The lights automatically turn on/off according to the engine switch position, whether the doors are locked/unlocked, and whether the doors are opened/closed.

- ▶ Vehicles with smart entry & start system

The lights automatically turn on/off according to engine switch mode, whether the doors are locked/unlocked, and whether the doors are opened/closed.

- If the following lights remain on when the engine switch is turned to the “LOCK” position (vehicles without smart entry & start system) or off (vehicles with smart entry & start system), the lights will go off automatically after 20 minutes:

- Personal/interior light
- Interior light (if equipped)
- Engine switch light (if equipped)

**NOTICE**

To prevent battery discharge, do not leave the lights on longer than necessary when the engine is not running.

تلفن شبانه روزی: ۰۲۱-۸۸۸۶۲۰۸۵

FarmaSOS.com

List of storage features

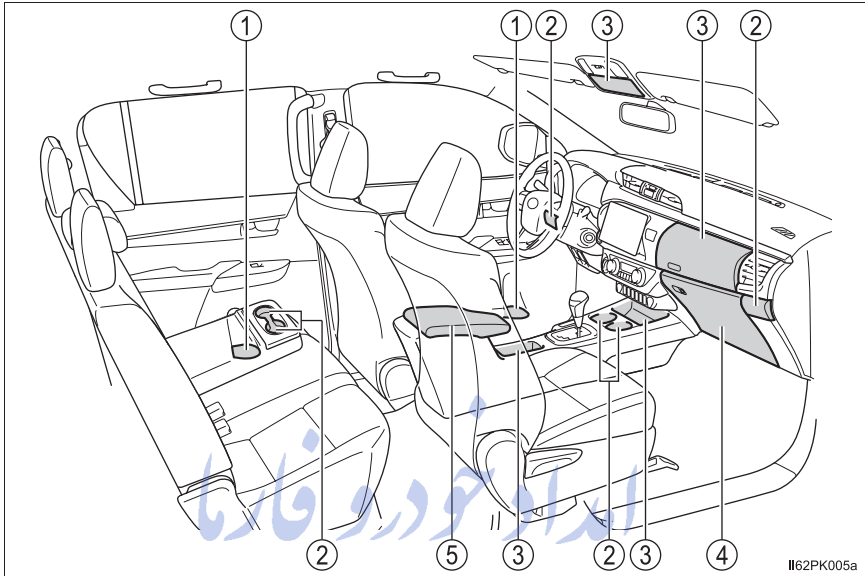

- | | |
|---|--|
| ① Bottle holders (if equipped)
(→P. 472) | ③ Auxiliary boxes (if equipped)
(→P. 473) |
| ② Cup holders (if equipped)
(→P. 471) | ④ Glove box
(→P. 470) |
| | ⑤ Console box (if equipped)
(→P. 470) |

⚠ WARNING

- Do not leave glasses, lighters or spray cans in the storage spaces, as this may cause the following when cabin temperature becomes high:
 - Glasses may be deformed by heat or cracked if they come into contact with other stored items.
 - Lighters or spray cans may explode. If they come into contact with other stored items, the lighter may catch fire or the spray can may release gas, causing a fire hazard.
- When driving or when the glove box and the console box are not in use, keep it closed.
In the event of sudden braking or sudden swerving, an accident may occur due to an occupant being struck by an open lid or the items stored inside.

Glove box

- ① Open (push button)
- ② Unlock with the master key or the mechanical key
- ③ Lock with the master key or the mechanical key

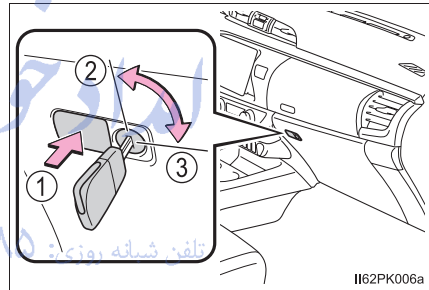

Console box (if equipped)

Lift the lid while pulling up the knob to release the lock.

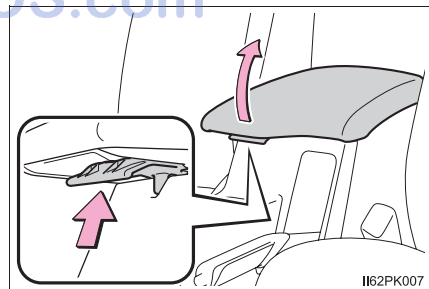

Cup holders

▶ Type A

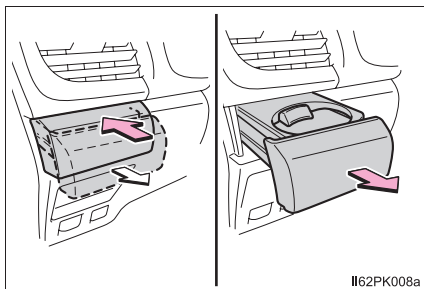

▶ Type B (if equipped)

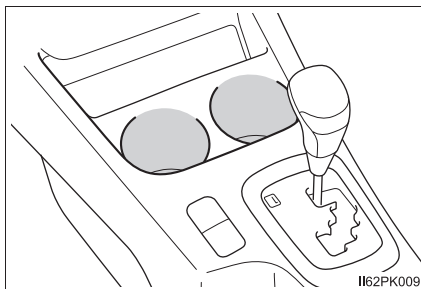

Press in and pull the cup holder.

▶ Type C (if equipped)

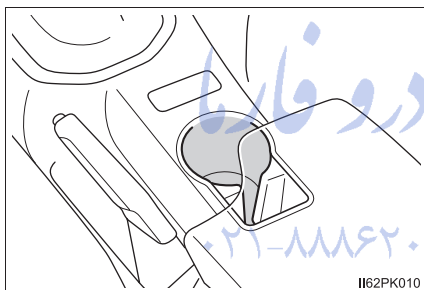

▶ Type D (if equipped)

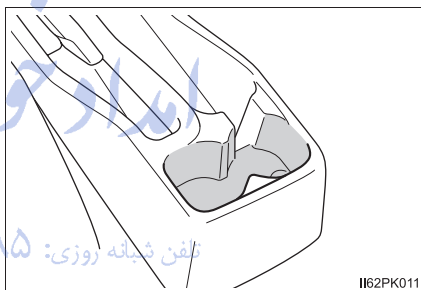

▶ Type E (if equipped)

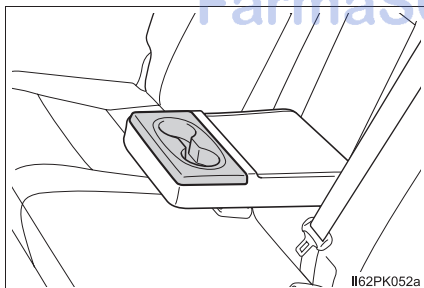

Pull the armrest down.

⚠ WARNING

Do not place anything other than cups or beverage cans in the cup holders. Even when the lid is closed, items must not be stored in the cup holders. Other items may be thrown out of the holders in the event of sudden braking, sudden swerving or an accident, cause injury. If possible, cover hot drinks to prevent burns.

Bottle holders

► For front seats

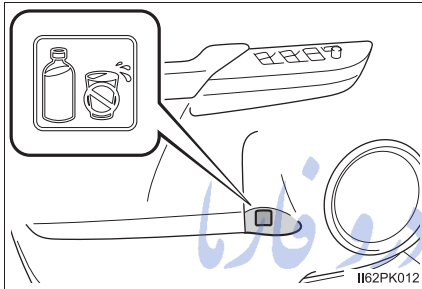

► For rear seats (if equipped)

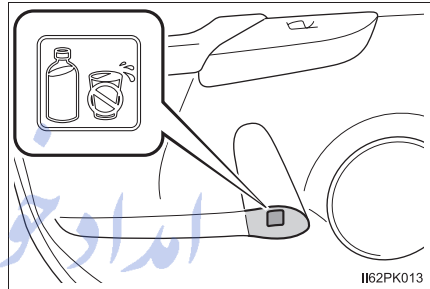

- When using the holder as a bottle holder:
 - When storing a bottle, close the cap.
 - The bottle may not be stored depending on its size or shape.

⚠ WARNING

Do not place anything other than a bottle in the bottle holders. Other items may be thrown out of the holders in the event of an accident or sudden braking and cause injury.

⚠ NOTICE

Do not place open bottles or glass and paper cups containing liquid in the bottle holders. The contents may spill and glasses may break.

Auxiliary boxes

► Type A

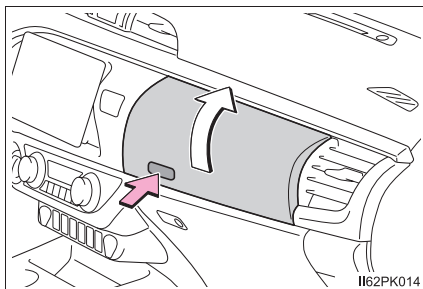

Press the button.

► Type B

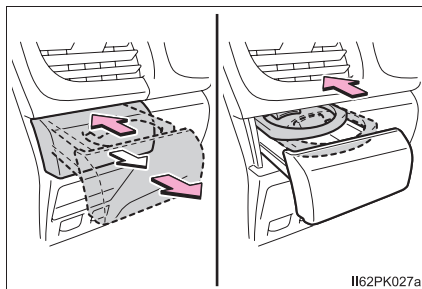

Press in and pull the cup holder, and push the cup tray.

► Type C

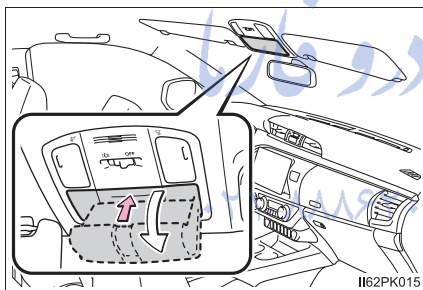

Press in the lid.

The auxiliary box is useful for temporarily storing sunglasses and similar small items.

► Type D*

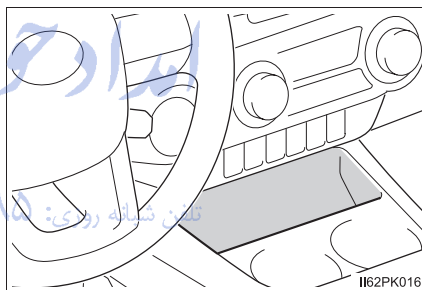

► Type E (if equipped)

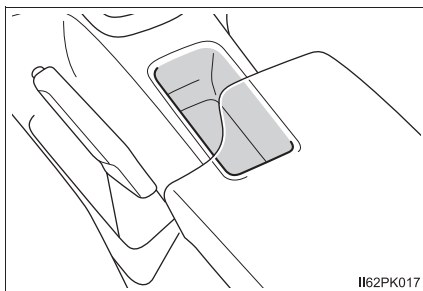

► Type F (if equipped)

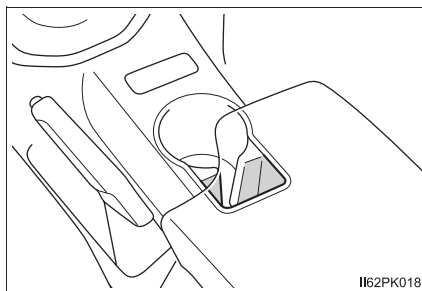

► Type G (if equipped)

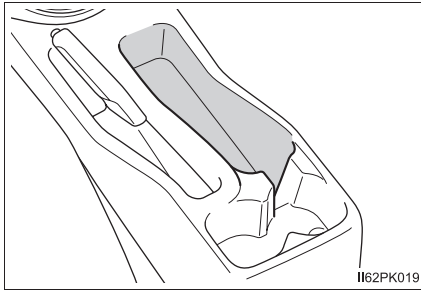

*: The shape of the auxiliary box may differ depending on the grade, etc.

- Air conditioning-linked temperature regulation function (type A) (if equipped):



By introducing air from the air conditioning system into the auxiliary box, canned drinks etc. can be kept hot or cold. However, as the temperature inside the auxiliary box will become the same as the temperature of the air flowing from the air conditioning system, extreme heating and cooling are not possible. In high humidity condition, be careful of objects inside the auxiliary box, as condensation may form.

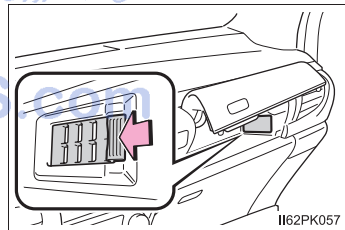

- Using the air conditioning-linked temperature regulation function (type A) (if equipped):

- 1 Open the air intake lid inside the auxiliary box.

To blow a large amount of air into the auxiliary box, close the passenger side vent. (→P. 451, 459)



- 2 Allow the air conditioning system to operate, and use  or  to

select either  or . (→P. 448, 457)

- 3 Adjust the temperature. (→P. 448, 456)

- Normal use (type A) (if equipped):
Close the air intake lid inside the auxiliary box.
- Items unsuitable for the auxiliary box (type A) (if equipped):
 - Drinks in unsealed container
 - Fragile items, perishables or anything with strong odor

⚠ WARNING

- Do not store items heavier than 0.2 kg (0.4 lb.).
Doing so may cause the auxiliary box to open and the items inside may fall out, resulting in an accident. (type C)
- Keep the auxiliary boxes closed. In the event of sudden braking, an accident may occur due to an occupant being struck by an open auxiliary box or the items stored inside. (type A, B and C)
- When using the auxiliary boxes, do not use the cup tray.
If a cup, aluminum can or bottle is placed in the auxiliary box, it may be thrown out of the box in the event of an accident or sudden braking, resulting in injury. (type B)

امداد خودرو فارما

تلفن شبانه روزی: ۰۲۱-۸۸۸۶۲۰۸۵

FarmaSOS.com

Luggage compartment features

Deck hooks (if equipped)

Deck hooks are provided for securing loose items.

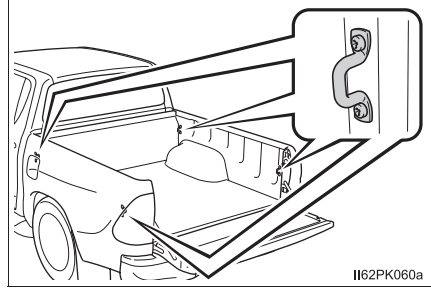

امداد خودرو فارما

تلفن شبانه روزی: ۰۲۱-۸۸۸۶۲۰۸۵

FarmaSOS.com

Other interior features

Sun visors

- ① To set the visor in the forward position, flip it down.
- ② To set the visor in the side position, flip down, unhook, and swing it to the side.

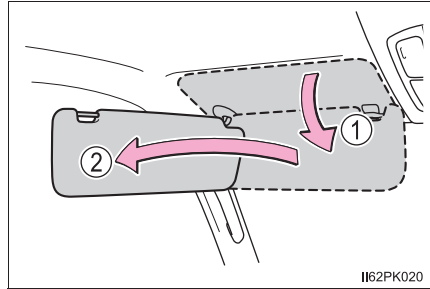

Vanity mirror (if equipped)

Open the cover to use.

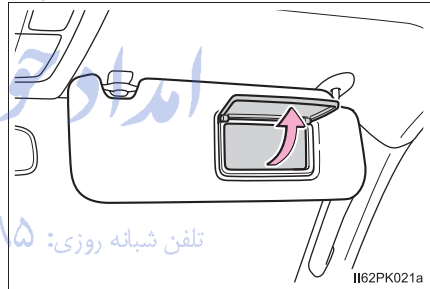

FarmaSOS.com

Clock

The clock can be adjusted by pressing the buttons.

- ① Adjusts the hours
- ② Adjusts the minutes
- ③ Rounds to the nearest hour*

*: e.g. 1:00 to 1:29 → 1:00
1:30 to 1:59 → 2:00

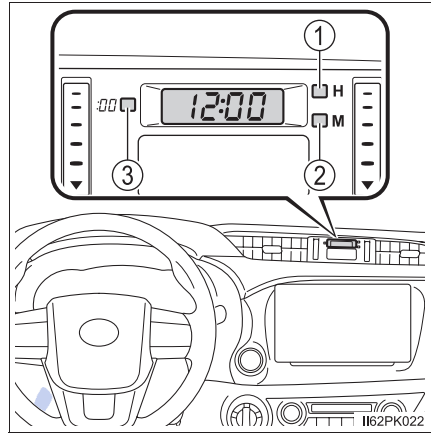

- The clock is displayed when:
 - ▶ Vehicles without smart entry & start system
The engine switch is in the “ACC” or “ON” position.
 - ▶ Vehicles with smart entry & start system
The engine switch is in ACCESSORY or IGNITION ON mode.
- When disconnecting and reconnecting battery terminals:
The time display will automatically be set to 1:00.

Power outlets (if equipped)

The power outlet can be used for the following components:

12 V DC:

Please use as a power supply for electronic goods that use less than 12 V DC / 10 A (power consumption of 120 W).

When using electronic goods, make sure that the power consumption of all the connected power outlets is less than 120 W.

220 V AC:

Accessories that use less than 100 W.

■ 12 V DC

Open the cover.

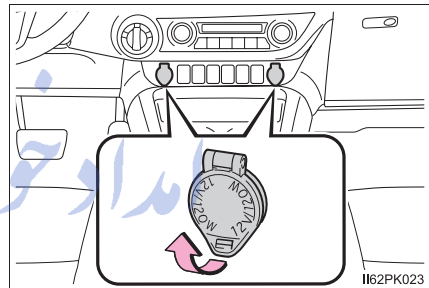

■ 220 V AC

Open the cover.

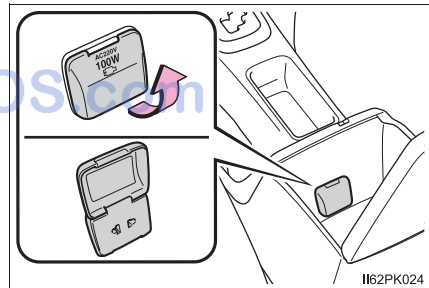

- The power outlet can be used when:
 - ▶ Vehicles without smart entry & start system
 - 12 V DC: The engine switch is in the “ACC” or “ON” position.
 - 220 V AC: The engine switch is in the “ON” position.
 - ▶ Vehicles with smart entry & start system
 - 12 V DC: The engine switch is in ACCESSORY or IGNITION ON mode.
 - 220 V AC: The engine switch is in IGNITION ON mode.
- Vehicles with Stop & Start system: When the engine restarts after having been stopped by the Stop & Start system, the power outlet may be temporarily unusable, but this is not a malfunction.



NOTICE

- To avoid damaging the power outlets, close the power outlet lid when the power outlet is not in use.
Foreign objects or liquids that enter the power outlet may cause a short circuit.
- To prevent blown fuse:
 - ▶ 12 V DC
Do not use an accessory that uses more than 12 V 10 A.
 - ▶ 220 V AC
Do not use a 220 V AC appliance that requires more than 100 W.
If a 220 V AC appliance that consumes more than 100 W is used, the protection circuit will cut the power supply.
- To prevent battery discharge, do not use the power outlet longer than necessary when the engine is not running.
- The following 220 V AC appliances may not operate properly even if their power consumption is under 100 W:
 - Appliances with high initial peak wattage
 - Measuring devices that process precise data
 - Other appliances that require an extremely stable power supply

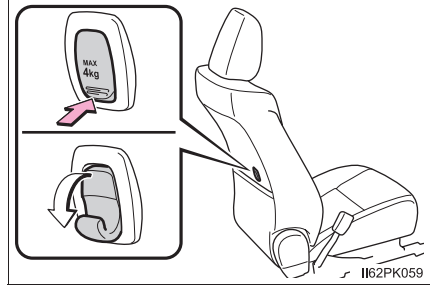
Grocery bag hooks (if equipped)**⚠ WARNING**

Keep the hooks returned in place when not in use.

⚠ NOTICE

Do not hang any object heavier than 4 kg (8.8 lb.).

تلفن شبانه روزی: ۰۲۱-۸۸۸۶۲۰۸۵

FarmaSOS.com

Coat hooks (if equipped)

The coat hooks are provided above the back window.

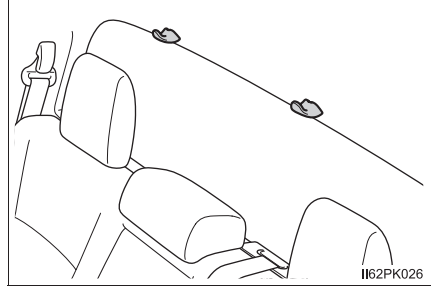

Armrest (if equipped)

Fold down the armrest for use.

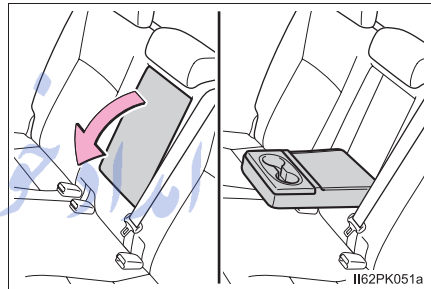

NOTICE

تلفن شبانه روزی: ۰۲۱-۸۸۸۶۲۰۸۵

To prevent damage to the armrest, do not apply too much load on the armrest.

FarmaSOS.com

ERA-GLONASS*

ERA-GLONASS is a telematics service that uses Global Navigation Satellite System (GLONASS) data and embedded cellular technology to enable the following emergency calls to be made: Automatic emergency calls (Automatic Collision Notification) and manual emergency calls (by pressing the “SOS” button). This service is required by Eurasian Customs Union Regulations.

System components

- ① Microphone
- ② “SOS” button
- ③ Indicator lights

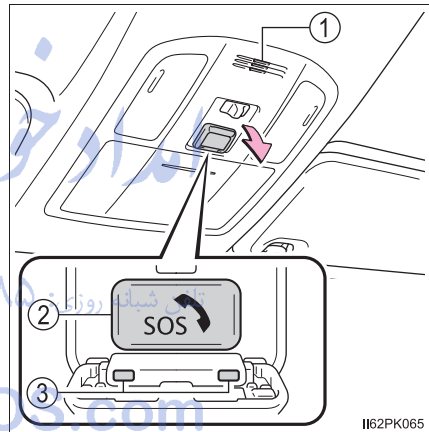

Emergency Notification Services

■ Automatic Collision Notification

If any airbag deploys, the system is designed to automatically call the Public Safety Answering Point (PSAP). The responding agent receives the vehicle's location and attempts to speak with the vehicle occupants to assess the level of emergency. If the occupants are unable to communicate, the agent automatically treats the call as an emergency, contacts the nearest emergency services provider to describe the situation, and requests that assistance be sent to the location.

*: If equipped

■ Emergency Assistance Button (“SOS”)

In the event of an emergency, push the “SOS” button to reach the Public Safety Answering Point (PSAP). The answering agent will determine your vehicle’s location, assess the emergency, and dispatch the necessary assistance required.

If you accidentally press the “SOS” button, tell the agent that you are not experiencing an emergency.

Indicator lights

When the engine switch is turned to the “ON” position (vehicles without smart entry & start system) or IGNITION ON mode (vehicles with smart entry & start system), the red indicator light will illuminate for 10 seconds and then the green indicator light will illuminate for 2 seconds, indicating that the system is enabled. The indicator lights indicate the following:

- If the green indicator light illuminates and stays on, the system is enabled.
- If the green indicator light flashes, an emergency call is being made (either automatically or manually).
- If no indicator lights illuminate, the system is not enabled.
- If the red indicator light illuminates any time other than immediately after the engine switch is turned to the “ON” position (vehicles without smart entry & start system) or IGNITION ON mode (vehicles with smart entry & start system), the system may be malfunctioning or the backup battery may be depleted. Contact any authorized Toyota dealer or repairer, or another duly qualified and equipped professional.

The service life of the backup battery is 3 years or more.

Maintenance and care

7

7-1. Maintenance and care	
Cleaning and protecting the vehicle exterior	486
Cleaning and protecting the vehicle interior	489
7-2. Maintenance	
Maintenance requirements.....	492
7-3. Do-it-yourself maintenance	
Do-it-yourself service precautions	495
Hood	497
Engine compartment.....	499
Tires.....	518
Tire inflation pressure	526
Wheels.....	528
Air conditioning filter	530
Wireless remote control/ electronic key battery.....	532
Checking and replacing fuses	535
Light bulbs	540

Cleaning and protecting the vehicle exterior

Perform the following to protect the vehicle and maintain it in prime condition:

- Working from top to bottom, liberally apply water to the vehicle body, wheel wells and underside of the vehicle to remove any dirt and dust.
- Wash the vehicle body using a sponge or soft cloth, such as a chamois.
- For hard-to-remove marks, use car wash soap and rinse thoroughly with water.
- Wipe away any water.
- Wax the vehicle when the waterproof coating deteriorates.
If water does not bead on a clean surface, apply wax when the vehicle body is cool.

■ Automatic car washes

- Fold the mirrors and remove the antenna before washing the vehicle. Start washing from the front of the vehicle. Make sure to re-install the antenna and extend the mirrors before driving.
- Brushes used in automatic car washes may scratch the vehicle surface and harm your vehicle's paint.

■ High pressure car washes

- Do not allow the nozzles of the car wash to come within close proximity of the windows.
- Vehicles with fuel filler door: Before using the car wash, check that the fuel filler door on your vehicle is closed properly.

■ Aluminum wheels (if equipped)

- Remove any dirt immediately by using a neutral detergent. Do not use hard brushes or abrasive cleaners. Do not use strong or harsh chemical cleaners. Use the same mild detergent and wax as used on the paint.
- Do not use detergent on the wheels when they are hot, for example after driving for long distance in the hot weather.
- Wash detergent from the wheels immediately after use.

■ Bumpers

Do not scrub with abrasive cleaners.

⚠ WARNING**■ When washing the vehicle**

Do not apply water to the inside of the engine compartment. Doing so may cause the electrical components etc. to catch fire.

■ Precautions regarding the exhaust pipe

Exhaust gasses cause the exhaust pipe to become quite hot.

When washing the vehicle, be careful not to touch the pipe until it has cooled sufficiently, as touching a hot exhaust pipe can cause burns.

تلفن شبانه روزی: ۰۲۱-۸۸۸۶۲۰۸۵

FarmaSOS.com



NOTICE

■ **To prevent paint deterioration and corrosion on the body and components (aluminum wheels etc.)**

- Wash the vehicle immediately in the following cases:
 - After driving near the sea coast
 - After driving on salted roads
 - If coal tar or tree sap is present on the paint surface
 - If dead insects, insect droppings or bird droppings are present on the paint surface
 - After driving in an area contaminated with soot, oily smoke, mine dust, iron powder or chemical substances
 - If the vehicle becomes heavily soiled with dust or mud
 - If liquids such as benzene and gasoline are spilled on the paint surface
- If the paint is chipped or scratched, have it repaired immediately.
- To prevent the wheels from corroding, remove any dirt and store in a place with low humidity when storing the wheels.

■ **Cleaning the exterior lights**

- Wash carefully. Do not use organic substances or scrub with a hard brush. This may damage the surfaces of the lights.
- Do not apply wax to the surfaces of the lights. Wax may cause damage to the lenses.

■ **Antenna installation and removal precautions**

- Before driving, ensure that the antenna is installed. تلفن
- When the antenna is removed, such as before entering an automatic car wash, make sure to store it in a suitable place so as not to lose it. Also, before driving, make sure to reinstall the antenna in its original position.

■ **When using a high pressure car wash**

Do not bring the nozzle tip close to boots (rubber or resin manufactured cover), connectors or the following parts. The parts may be damaged if they come into contact with high-pressure water.

- Traction related parts
- Steering parts
- Suspension parts
- Brake parts

Cleaning and protecting the vehicle interior

The following procedures will help protect your vehicle's interior and keep it in top condition:

Protecting the vehicle interior

- Remove dirt and dust using a vacuum cleaner. Wipe dirty surfaces with a cloth dampened with lukewarm water.
- If dirt cannot be removed, wipe it off with a soft cloth dampened with neutral detergent diluted to approximately 1%.
- Wring out any excess water from the cloth and thoroughly wipe off remaining traces of detergent and water.

Cleaning the leather areas

- Remove dirt and dust using a vacuum cleaner.
- Wipe off any excess dirt and dust with a soft cloth dampened with diluted detergent.
Use a diluted water solution of approximately 5% neutral wool detergent.
- Wring out any excess water from the cloth and thoroughly wipe off all remaining traces of detergent.
- Wipe the surface with a dry, soft cloth to remove any remaining moisture. Allow the leather to dry in a shaded and ventilated area.

Cleaning the synthetic leather areas

- Remove dirt and dust using a vacuum cleaner.
- Wipe it off with a soft cloth dampened with neutral detergent diluted to approximately 1%.
- Wring out any excess water from the cloth and thoroughly wipe off remaining traces of detergent and water.

■ Caring for leather areas

Toyota recommends cleaning the interior of the vehicle at least twice a year to maintain the quality of the vehicle's interior.

■ Shampooing the carpets

There are several commercial foaming-type cleaners available. Use a sponge or brush to apply the foam. Rub in overlapping circles. Do not use water. Wipe dirty surfaces and let them dry. Excellent results are obtained by keeping the carpet as dry as possible.

■ Seat belts

Clean with mild soap and lukewarm water using a cloth or sponge. Also check the belts periodically for excessive wear, fraying or cuts.

**WARNING****■ Water in the vehicle**

- Do not splash or spill liquid in the vehicle.
Doing so may cause electrical components etc. to malfunction or catch fire.
- Do not get any of the SRS components or wiring in the vehicle interior wet. (→P. 46)
An electrical malfunction may cause the airbags to deploy or not function properly, resulting in death or serious injury.

■ Cleaning the interior (especially instrument panel)

Do not use polish wax or polish cleaner. The instrument panel may reflect off the windshield, obstructing the driver's view and leading to an accident, resulting in death or serious injury.

 NOTICE**■ Cleaning detergents**

- Do not use the following types of detergent, as they may discolor the vehicle interior or cause streaks or damage to painted surfaces:
 - Non-seat portions: Organic substances such as benzene or gasoline, alkaline or acidic solutions, dye, and bleach
 - Seats: Alkaline or acidic solutions, such as thinner, benzene, and alcohol
- Do not use polish wax or polish cleaner. The instrument panel's or other interior part's painted surface may be damaged.

■ Preventing damage to leather surfaces

Observe the following precautions to avoid damage to and deterioration of leather surfaces:

- Remove any dust or dirt from leather surfaces immediately.
- Do not expose the vehicle to direct sunlight for extended periods of time. Park the vehicle in the shade, especially during summer.
- Do not place items made of vinyl, plastic, or containing wax on the upholstery, as they may stick to the leather surface if the vehicle interior heats up significantly.

■ Water on the floor

Do not wash the vehicle floor with water.

Vehicle systems such as the audio system may be damaged if water comes into contact with electrical components such as the audio system above or under the floor of the vehicle. Water may also cause the body to rust.

■ When cleaning the inside of the windshield (vehicles with Toyota Safety Sense)

Do not allow glass cleaner to contact the lens. Also, do not touch the lens. (→P. 281)

■ Cleaning the inside of the rear window (vehicles with rear window defogger)

- Do not use glass cleaner to clean the rear window, as this may cause damage to the rear window defogger heater wires. Use a cloth dampened with lukewarm water to gently wipe the window clean. Wipe the window in strokes running parallel to the heater wires.
- Be careful not to scratch or damage the heater wires.

Maintenance requirements

To ensure safe and economical driving, day-to-day care and regular maintenance are essential. Toyota recommends the following maintenance:

Scheduled maintenance

Scheduled maintenance should be performed at specified intervals according to the maintenance schedule.

For full details of your maintenance schedule, refer to the “Toyota Service Booklet” or “Toyota Warranty Booklet”.

Do-it-yourself maintenance

What about do-it-yourself maintenance?

Many maintenance items are easy to do yourself if you have a little mechanical ability and a few basic automotive tools.

Note, however, that some maintenance tasks require special tools and skills. These are best performed by qualified technicians. Even if you're an experienced do-it-yourself mechanic, we recommend that repairs and maintenance be conducted by any authorized Toyota dealer or repairer, or another duly qualified and equipped professional. Any authorized Toyota dealer or repairer will keep a record of maintenance, which could be useful should you ever require Warranty Service. Should you choose to select a qualified and equipped professional other than an authorized Toyota repairer to service or maintain your vehicle, we recommend that you request that a record of maintenance be kept.

■ Where to go for maintenance service?

In order to maintain your vehicle in the best possible condition, Toyota recommends that maintenance service operations as well as other inspections and repairs be carried out by authorized Toyota dealers or repairers or other duly qualified and equipped professionals. For repairs and services covered by your warranty, please visit an authorized Toyota dealer or repairer, who will use genuine Toyota parts in repairing any difficulties you may encounter. There can also be advantages in utilizing authorized Toyota dealers or repairers for non-warranty repairs and services, as members of the Toyota network will be able to expertly assist you with any difficulties you may encounter.

Your Toyota dealer or repairer, or another duly qualified and equipped professional will perform all of the scheduled maintenance on your vehicle reliably and economically due to their experience with Toyota vehicles.

■ Does your vehicle need repairs?

Be on the alert for changes in performance and sounds, and visual tip-offs that indicate service is needed. Some important clues are:

- Engine missing, stumbling or pinging
- Appreciable loss of power
- Strange engine noises
- A fluid leak under the vehicle (However, water dripping from the air conditioning system after use is normal.)
- Change in exhaust sound (This may indicate a dangerous carbon monoxide leak. Drive with the windows open, and have the exhaust system checked immediately.)
- Flat-looking tires, excessive tire squeal when cornering, uneven tire wear
- Vehicle pulls to one side when driven straight on a level road
- Strange noises related to suspension movement
- Loss of brake effectiveness, spongy feeling brake pedal or clutch pedal, pedal almost touches the floor, vehicle pulls to one side when braking
- Engine coolant temperature continually higher than normal

If you notice any of these clues, take your vehicle to any authorized Toyota dealer or repairer, or another duly qualified and equipped professional as soon as possible. Your vehicle may need adjustment or repair.

 WARNING**■ If your vehicle is not properly maintained**

Improper maintenance could result in serious damage to the vehicle and possible serious injury or death.

■ Handling of the battery

Battery posts, terminals and related accessories contain lead and lead compounds which are known to cause brain damage. Wash your hands after handling. (→P. 507)

امداد خودرو فارما

تلفن شبانه روزی: ۰۲۱-۸۸۸۶۲۰۸۵

FarmaSOS.com

Do-it-yourself service precautions

If you perform maintenance by yourself, be sure to follow the correct procedure as given in these sections.

Items	Parts and tools
Battery condition (→P. 507)	<ul style="list-style-type: none"> • Warm water • Baking soda • Grease • Conventional wrench (for terminal clamp bolts) • Distilled water
Engine coolant level (→P. 505)	<ul style="list-style-type: none"> • “Toyota Super Long Life Coolant” or a similar high quality ethylene glycol-based non-silicate, non-amine, non-nitrite and non-borate coolant with long-life hybrid organic acid technology • “Toyota Super Long Life Coolant” is pre-mixed with 50% coolant and 50% deionized water. • Funnel (used only for adding coolant)
Engine oil level (→P. 502)	<ul style="list-style-type: none"> • “Toyota Genuine Motor Oil” or equivalent • Rag or paper towel • Funnel (used only for adding engine oil)
Fuses (→P. 535)	<ul style="list-style-type: none"> • Fuse with same amperage rating as original
Light bulbs (→P. 540)	<ul style="list-style-type: none"> • Bulb with same number and wattage rating as original • Phillips-head screwdriver • Flathead screwdriver • Wrench
Radiator, condenser and intercooler (if equipped) (→P. 506)	—
Tire inflation pressure (→P. 526)	<ul style="list-style-type: none"> • Tire pressure gauge • Compressed air source
Washer fluid (→P. 511)	<ul style="list-style-type: none"> • Water or washer fluid containing antifreeze (for winter use) • Funnel (used only for adding water or washer fluid)

 **WARNING**

The engine compartment contains many mechanisms and fluids that may move suddenly, become hot, or become electrically energized. To avoid death or serious injury, observe the following precautions.

■ **When working on the engine compartment**

- Keep hands, clothing and tools away from the moving fan and engine drive belt.
- Be careful not to touch the engine, radiator, exhaust manifold, etc. right after driving as they may be hot. Oil and other fluids may also be hot.
- Do not leave anything that may burn easily, such as paper and rags, in the engine compartment.
- Do not smoke, cause sparks or expose an open flame to fuel or the battery. Fuel and battery fumes are flammable.
- Be extremely cautious when working on the battery. It contains poisonous and corrosive sulfuric acid.
- Take care because brake fluid can harm your hands or eyes and damage painted surfaces. If fluid gets on your hands or in your eyes, flush the affected area with clean water immediately.
If you still experience discomfort, consult a doctor.

■ **Safety glasses**

Wear safety glasses to prevent flying or falling material, fluid spray, etc. from getting in your eyes.

 **NOTICE**

■ **If you remove the air cleaner filter**

Driving with the air cleaner filter removed may cause excessive engine wear due to dirt in the air.

■ **If the fluid level is low or high**

It is normal for the brake fluid level to go down slightly as the brake pads wear or when the fluid level in the accumulator is high.

If the reservoir needs frequent refilling, it may indicate a serious problem.

Hood

Release the lock from the inside of the vehicle to open the hood.

- 1 Pull the hood lock release lever.
The hood will pop up slightly.

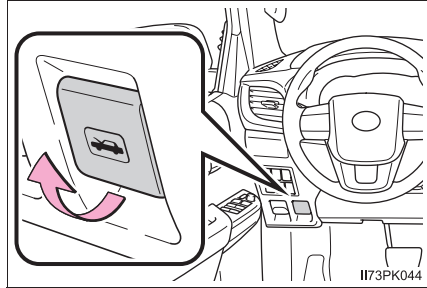

- 2 Pull up the auxiliary catch lever and lift the hood.

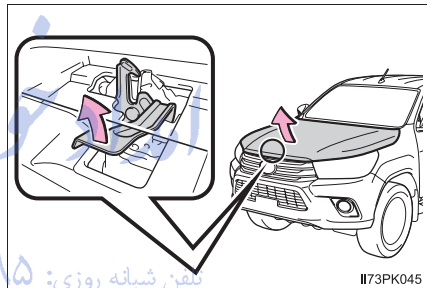

- 3 Hold the hood open by inserting the supporting rod into either of the slots.

- ① Lower
- ② Normal

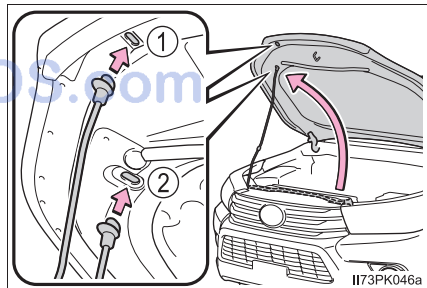

 WARNING**■ Pre-driving check**

Check that the hood is fully closed and locked.

If the hood is not locked properly, it may open while the vehicle is in motion and cause an accident, which may result in death or serious injury.

■ After installing the support rod into the slot

Make sure the rod supports the hood securely from falling down on to your head or body.

 NOTICE**■ When closing the hood**

Be sure to return the support rod to its clip before closing the hood. Closing the hood with the support rod up could cause the hood to bend.

امداد خودرو فارما

تلفن شبانه روزی: ۰۲۱-۸۸۸۶۲۰۸۵

FarmaSOS.com

Engine compartment

► 2TR-FE engine

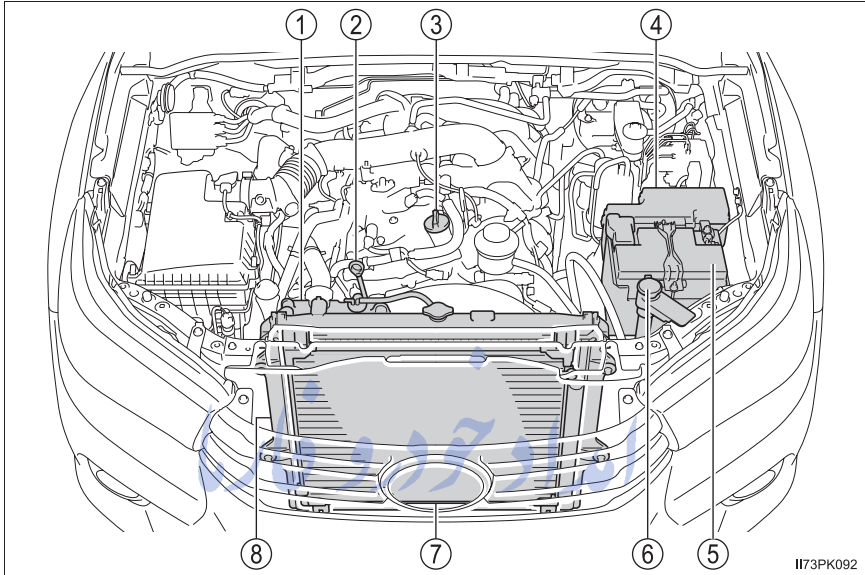

1173PK092

- | | |
|--|----------------------------------|
| ① Engine coolant reservoir
(→P. 505) | ④ Fuse box تلفن
(→P. 535) |
| ② Engine oil level dipstick
(→P. 502) | ⑤ Battery
(→P. 507) |
| ③ Engine oil filler cap (→P. 503) | ⑥ Washer fluid tank
(→P. 511) |
| | ⑦ Condenser
(→P. 506) |
| | ⑧ Radiator
(→P. 506) |

► 1GD-FTV and 2GD-FTV engines

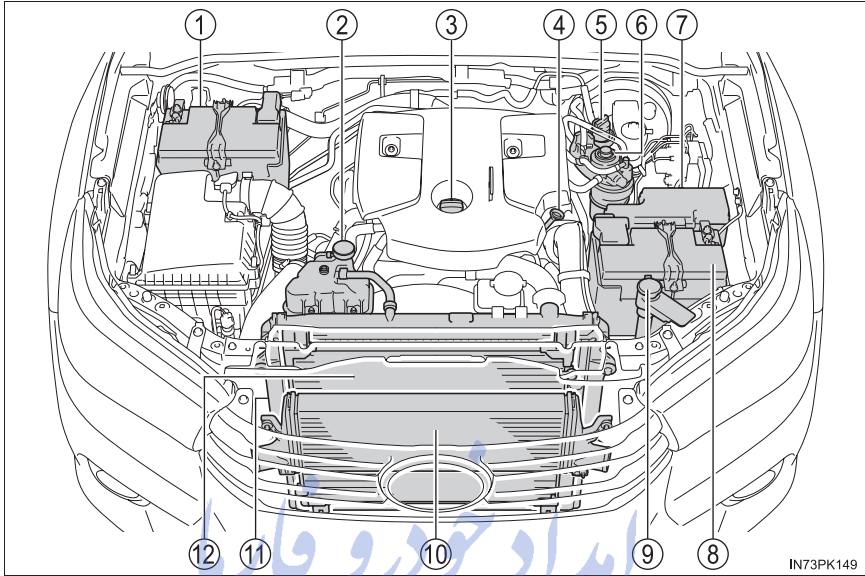

- | | |
|---|--|
| ① Battery (if equipped)
(→P. 507) | ⑥ Fuel filter (→P. 512, 616) |
| ② Engine coolant reservoir
(→P. 505) | ⑦ Fuse box (→P. 535) |
| ③ Engine oil filler cap (→P. 503) | ⑧ Battery (→P. 507) |
| ④ Engine oil level dipstick
(→P. 502) | ⑨ Washer fluid tank (→P. 511) |
| ⑤ AdBlue™ tank cap
(if equipped) (→P. 513) | ⑩ Intercooler (→P. 506) |
| | ⑪ Radiator (→P. 506) |
| | ⑫ Condenser (if equipped)
(→P. 506) |

► 2KD-FTV engine

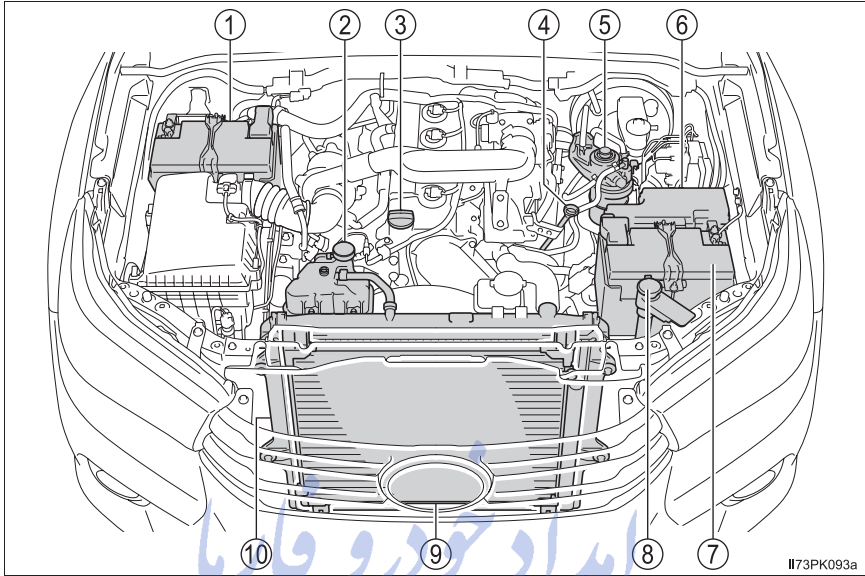

- | | |
|--|----------------------------------|
| ① Battery (if equipped)
(→P. 507) | ⑤ Fuel filter
(→P. 512, 616) |
| ② Engine coolant reservoir
(→P. 505) | ⑥ Fuse box
(→P. 535) |
| ③ Engine oil filler cap (→P. 503) | ⑦ Battery
(→P. 507) |
| ④ Engine oil level dipstick
(→P. 502) | ⑧ Washer fluid tank
(→P. 511) |
| | ⑨ Condenser
(→P. 506) |
| | ⑩ Radiator
(→P. 506) |

Engine oil

With the engine at operating temperature and turned off, check the oil level on the dipstick.

■ Checking the engine oil

- 1 Park the vehicle on level ground. After warming up the engine and turning it off, wait more than 5 minutes for the oil to drain back into the bottom of the engine.
- 2 Remove the sand and dust from around the dipstick.
- 3 Holding a rag under the end, pull the dipstick out.

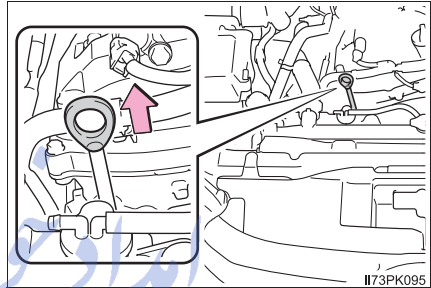

- 4 Wipe the dipstick clean.

Make sure that the inlet of the oil level gauge guide and O-ring of the dipstick are free from sand and dust.

If the O-ring is damaged, replace it with a new one.

- 5 Reinsert the dipstick fully.
- 6 Holding a rag under the end, pull the dipstick out and check the oil level.

- ① Low
- ② Normal
- ③ Excessive

The shape of the dipstick may differ depending on the type of vehicle or engine.

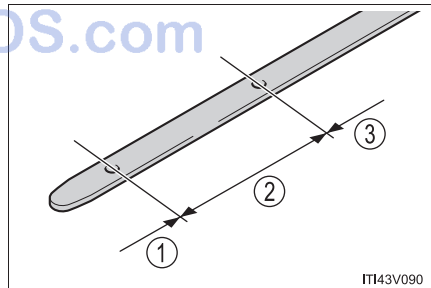

- 7 Wipe the dipstick and reinsert it fully.

■ Adding engine oil

If the oil level is below or near the low level mark, add engine oil of the same type as that already in the engine.

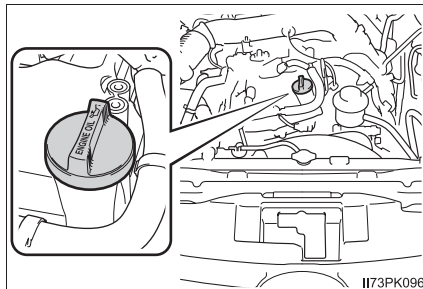

Make sure to check the oil type and prepare the items needed before adding oil.

Engine oil selection		→P. 628
Oil quantity (Low → Full)	2TR-FE, 1GD-FTV and 2GD-FTV engines	1.5 L (1.6 qt., 1.3 Imp.qt.)
	2KD-FTV engine	1.6 L (1.7 qt., 1.4 Imp.qt.)
Items		Clean funnel

- 1 Remove the sand and dust from around the oil filler cap.
- 2 Remove the oil filler cap by turning it counterclockwise.
- 3 Add engine oil slowly, checking the dipstick.
- 4 Install the oil filler cap by turning it clockwise.

■ Engine oil consumption

A certain amount of engine oil will be consumed while driving. In the following situations, oil consumption may increase, and engine oil may need to be refilled in between oil maintenance intervals.

- When the engine is new, for example directly after purchasing the vehicle or after replacing the engine
- If low quality oil or oil of an inappropriate viscosity is used
- When driving at high engine speeds or with a heavy load, when towing (models for model code destination W*), or when driving while accelerating or decelerating frequently
- When leaving the engine idling for a long time, or when driving frequently through heavy traffic

*: See “Checking your vehicle’s model” if you are not sure of which model your vehicle is. (→P. 11)

■ After changing the engine oil (models for model code destination W*)

The engine oil maintenance data should be reset. Perform the following procedures:

- 1 Switch the display to the trip meter A (→P. 130) when the engine switch is in the “ON” position (vehicles without smart entry & start system) or IGNITION ON mode (vehicles with smart entry & start system).
- 2 Turn the engine switch to the “LOCK” position (vehicles without smart entry & start system) or off (vehicles with smart entry & start system).
- 3 While pressing the odometer/trip meter display change button (→P. 130), turn the engine switch to the “ON” position (vehicles without smart entry & start system) or IGNITION ON mode (vehicles with smart entry & start system). (Do not start the engine because reset mode will be canceled.) Continue to press and hold the button for more than one second after the trip meter displays “000000”.

*: See “Checking your vehicle’s model” if you are not sure of which model your vehicle is. (→P. 11)

WARNING

■ Used engine oil

- Used engine oil contains potentially harmful contaminants which may cause skin disorders such as inflammation and skin cancer, so care should be taken to avoid prolonged and repeated contact. To remove used engine oil from your skin, wash thoroughly with soap and water.
- Dispose of used oil and filters only in a safe and acceptable manner. Do not dispose of used oil and filters in household trash, in sewers or onto the ground. Call any authorized Toyota dealer or repairer, or another duly qualified and equipped professional, service station or auto parts store for information concerning recycling or disposal.
- Do not leave used engine oil within the reach of children.

NOTICE

■ To prevent serious engine damage

Check the oil level on a regular basis.

■ When replacing the engine oil

- Be careful not to spill engine oil on the vehicle components.
- Avoid overfilling, or the engine could be damaged.
- Check the oil level on the dipstick every time you refill the vehicle.
- Be sure the engine oil filler cap is properly tightened.

Engine coolant

The coolant level is satisfactory if it is between the “F” and “L” lines on the reservoir when the engine is cold.

▶ Gasoline engine

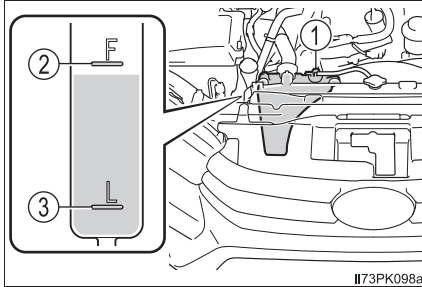

▶ Diesel engine

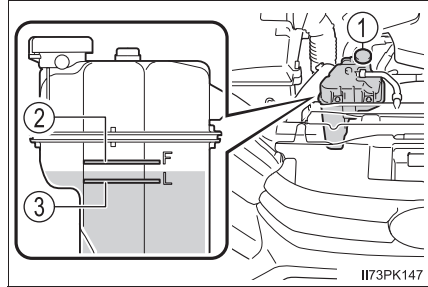

① Reservoir cap

③ “L” line

② “F” line

If the level is on or below the “L” line, add coolant up to the “F” line.
(→P. 613)

■ Coolant selection

Only use “Toyota Super Long Life Coolant” or a similar high quality ethylene glycol based non-silicate, non-amine, non-nitrite, and non-borate coolant with long-life hybrid organic acid technology.

“Toyota Super Long Life Coolant” is a mixture of 50% coolant and 50% deionized water. (Minimum temperature: -35°C [-31°F])

For more details about engine coolant, contact any authorized Toyota dealer or repairer, or another duly qualified and equipped professional.

■ If the coolant level drops within a short time of replenishing

Visually check the radiator, hoses, engine coolant reservoir cap, drain cock and water pump. If you cannot find a leak, have any authorized Toyota dealer or repairer, or another duly qualified and equipped professional test the cap and check for leaks in the cooling system.

 **WARNING****■ When the engine is hot**

Do not remove the radiator cap or the engine coolant reservoir cap. The cooling system may be under pressure and may spray hot coolant if the cap is removed, causing serious injuries, such as burns.

 **NOTICE****■ When adding coolant**

Coolant is neither plain water nor straight antifreeze. The correct mixture of water and antifreeze must be used to provide proper lubrication, corrosion protection and cooling. Be sure to read the antifreeze or coolant label.

■ If you spill coolant

Be sure to wash it off with water to prevent it from damaging parts or paint.

■ Notice on coolant quality

Do not use improper coolant. If improper coolant is used, the engine cooling system may be damaged.

Radiator, condenser and intercooler (if equipped)

Check the radiator, condenser and intercooler and clear away any foreign objects. If any of the above parts is extremely dirty or you are not sure of their condition, have your vehicle inspected by any authorized Toyota dealer or repairer, or another duly qualified and equipped professional.

 **WARNING****■ When the engine is hot**





Do not touch the radiator, condenser or intercooler as they may be hot and cause serious injuries, such as burns.

Battery

Check the battery as follows.

■ Caution symbols

The meanings of each caution symbol on the top of the battery are as follows:

	No smoking, no naked flames, no sparks		Battery acid
	Shield eyes		Note operating instructions
	Keep away from children		Explosive gas

■ Battery exterior

Make sure that the battery terminals are not corroded and that there are no loose connections, cracks, or loose clamps.

- ① Terminals
- ② Hold-down clamp

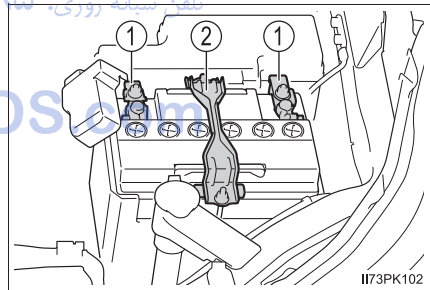

■ Checking battery fluid (vehicles with maintenance type battery)

If there are lines on the side of the battery:

Check that the level is between the upper and lower lines.

- ① Upper line
- ② Lower line

If the fluid level is at or below the lower line, add distilled water.

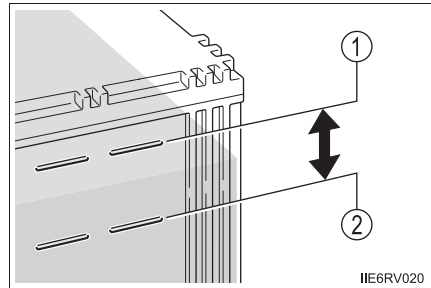

If there are not lines on the side of the battery:

Check the fluid level as follows.

- 1 Remove the vent plug.
- 2 Check the fluid level by looking directly at the cell.

If the fluid level is low, add distilled water.

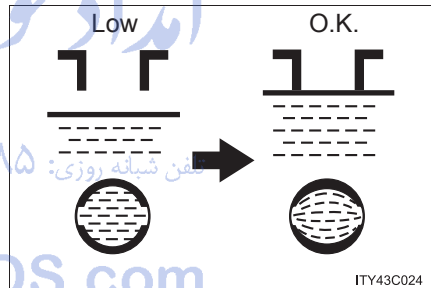

- 3 Put the vent plug back on and close it securely.

■ Adding distilled water (vehicles with maintenance type battery)

- 1 Remove the vent plug.
- 2 Add distilled water.
- 3 Put the vent plug back on and close it securely.

■ Before recharging

When recharging, the battery produces hydrogen gas which is flammable and explosive. Therefore, observe the following before recharging:

- If recharging with the battery installed on the vehicle, be sure to disconnect the ground cable.
- Make sure the power switch on the charger is off when connecting and disconnecting the charger cables to the battery.

■ After recharging/reconnecting the battery (vehicles with smart entry & start system)

The engine may not start. Follow the procedure below to initialize the system.

- 1 Shift the shift lever to P (automatic transmission) or depress the brake pedal with the shift lever in N (manual transmission).
- 2 Open and close any of the doors.
- 3 Restart the engine.
 - Unlocking the doors using the smart entry & start system may not be possible immediately after reconnecting the battery. If this happens, use the wireless remote control or the mechanical key to lock/unlock the doors.
 - Start the engine with the engine switch in ACCESSORY mode. The engine may not start with the engine switch turned off. However, the engine will operate normally from the second attempt.
 - The engine switch mode is recorded by the vehicle. If the battery is reconnected, the vehicle will return the engine switch mode to the status it was in before the battery was disconnected. Make sure to turn off the engine before disconnect the battery. Take extra care when connecting the battery if the engine switch mode prior to discharge is unknown.

If the system will not start even after multiple attempts, contact any authorized Toyota dealer or repairer, or another duly qualified and equipped professional.

■ If a symbol of a battery is shown on the multi-information display (if equipped)

There is a malfunction in the vehicle's charging system.

Immediately stop the vehicle in a safe place and contact any authorized Toyota dealer or repairer, or another duly qualified and equipped professional. Continuing to drive the vehicle may be dangerous.

 **WARNING**
■ Chemicals in the battery

Batteries contain poisonous and corrosive sulfuric acid and may produce hydrogen gas which is flammable and explosive. To reduce the risk of death or serious injury, take the following precautions while working on or near the battery:

- Do not cause sparks by touching the battery terminals with tools.
- Do not smoke or light a match near the battery.
- Avoid contact with eyes, skin and clothes.
- Never inhale or swallow electrolyte.
- Wear protective safety glasses when working near the battery.
- Keep children away from the battery.

■ Where to safely charge the battery

Always charge the battery in an open area. Do not charge the battery in a garage or closed room where there is insufficient ventilation.

■ How to recharge the battery (vehicles with maintenance-free type battery)

Only perform a slow charge (5 A or less). The battery may explode if charged at a quicker rate.

■ Emergency measures regarding electrolyte

- If electrolyte gets in your eyes
Flush your eyes with clean water for at least 15 minutes and get immediate medical attention. If possible, continue to apply water with a sponge or cloth while traveling to the nearest medical facility.
- If electrolyte gets on your skin
Wash the affected area thoroughly. If you feel pain or burning, get medical attention immediately.
- If electrolyte gets on your clothes
It can soak through clothing on to your skin. Immediately take off the clothing and follow the procedure above if necessary.
- If you accidentally swallow electrolyte
Drink a large quantity of water or milk. Get emergency medical attention immediately.
- When there is insufficient battery fluid
Do not use if there is insufficient fluid in the battery. There is a possible danger that the battery may explode.

■ When disconnecting the battery

Do not disconnect the negative (-) terminal on the body. The disconnected negative (-) terminal may touch the positive (+) terminal, which may cause a short and result in death or serious injury.

 NOTICE

■ **When recharging the battery**

Never recharge the battery while the engine is running. Also, be sure all accessories are turned off.

■ **When adding distilled water (vehicles with maintenance type battery)**

Avoid overfilling. Water spilled during battery recharging may cause corrosion.

Washer fluid

Add washer fluid in the following situations:

- A washer does not work.
- The warning message appears on the multi-information display (if equipped).

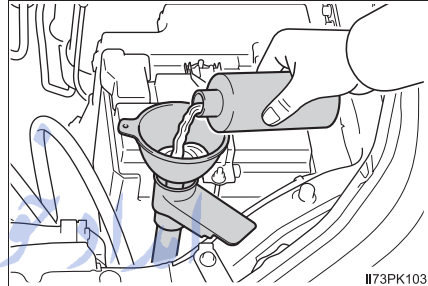

 WARNING

■ **When adding washer fluid**

Do not add washer fluid when the engine is hot or running as washer fluid contains alcohol and may catch fire if spilled on the engine etc.

 NOTICE

■ **Do not use any fluid other than washer fluid**

Do not use soapy water or engine antifreeze instead of washer fluid. Doing so may cause streaking on the vehicle's painted surfaces.

■ **Diluting washer fluid**

Dilute washer fluid with water as necessary. Refer to the freezing temperatures listed on the label of the washer fluid bottle.

Fuel filter (diesel engine only)

You may drain the fuel filter yourself. However, as the operation is difficult, we recommend having it drained by any authorized Toyota dealer or repairer, or another duly qualified and equipped professional. Even if you decide to drain it yourself, contact any authorized Toyota dealer or repairer, or another duly qualified and equipped professional.

The water in the fuel filter needs to be drained if one of the following symptoms occurs:

- ▶ Vehicles without multi-information display
When the fuel system warning light flashes and a buzzer sounds. (→P. 569)
- ▶ Vehicles with multi-information display
When “WATER ACCUMULATION IN FUEL FILTER SEE OWNER’S MANUAL”/“Water accumulation in fuel filter See owner’s manual” is shown on the multi-information display and a buzzer sounds*1.

- 1 Vehicles without smart entry & start system: Turn the engine switch to the “LOCK” position.
Vehicles with smart entry & start system: Turn the engine switch off.
- 2 Place a small tray under the drain plug or drain hose to catch the water and any fuel that comes out.
- 3 Perform the draining as shown in the illustration.

- ① Turn the drain plug counter-clockwise about 2 to 2 1/2 turns.

Loosening more than this will cause water oozing from around the drain plug.

- ② Operate the priming pump until fuel begins to run out.

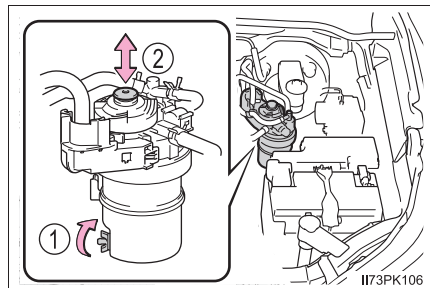

- 4 After draining, tighten the drain plug by hand.

*1: Models for model code destination V and Blank*2

*2: See “Checking your vehicle’s model” if you are not sure of which model your vehicle is. (→P. 11)

AdBlue™ (if equipped)

AdBlue™ is used to reduce the amount of nitrogen oxides in exhaust gas. AdBlue™ is consumed in the process of driving. Therefore, observe the following precautions.

- 1.0 L (1.1 qt., 0.9 Imp.qt.) of AdBlue™ is consumed every 1000 km (621 miles) to 1500 km (932 miles). Normally, after a full refill, the vehicle can be driven for approximately 15000 km (9321 miles) before all AdBlue™ is depleted. However, AdBlue™ may become completely depleted sooner depending on driving conditions.
- When the possible driving range based on the remaining amount of AdBlue™ reaches approximately 2400 km (1492 miles), the low AdBlue™ level warning light turns on and a warning message is displayed.
- When AdBlue™ is depleted, the engine cannot be restarted.
- If AdBlue™ is accidentally spilled while refilling, vehicle parts, paint, etc. may be damaged.

When AdBlue™ needs to be refilled, have it refilled at any authorized Toyota dealer or repairer, or another duly qualified and equipped professional.

It may be a criminal offence to use a vehicle that does not consume any reagent if it is required for the reduction of emissions.

■ AdBlue™ warning light and warning message

When the AdBlue™ level is low, the low AdBlue™ level warning light turns on and a warning message appears on the multi-information display. (→P. 582)

When refilling AdBlue™ by yourself in an emergency, be sure to follow the correct refilling procedures. (→P. 515)

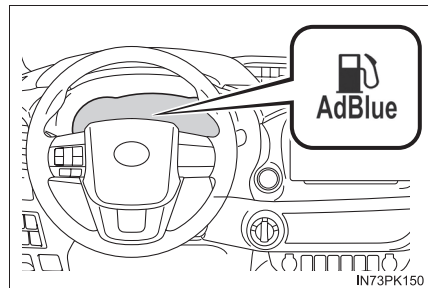

■ Refilling AdBlue™

- Use AdBlue™ (compliant with ISO 22241-1). AdBlue™ is a trademark of the German Association of the Automotive Industry (VDA).
- Before driving for a long period of time in an area where AdBlue™ cannot be refilled, consult any authorized Toyota dealer or repairer, or another duly qualified and equipped professional.

**NOTICE****■ When the AdBlue™ level is low**

When AdBlue™ is depleted, the engine cannot be restarted. Be sure to have AdBlue™ refilled at any authorized Toyota dealer or repairer, or another duly qualified and equipped professional before it is completely depleted.

امداد خودرو فارما

تلفن شبانه روزی: ۰۲۱-۸۸۸۶۲۰۸۵

FarmaSOS.com

■ Refilling AdBlue™ by yourself in an emergency

When the engine cannot be restarted due to the depletion of AdBlue™, adding approximately 5.0 L (5.3 qt., 4.4 Imp.qt.) or more of AdBlue™ will allow the engine to be started again. Perform the following procedures to refill AdBlue™. (The AdBlue™ tank has a capacity of 13.8 L [14.6 qt., 12.1 Imp.qt.])

► Refilling with the refilling equipment

1 Park the vehicle on a level surface, turn the engine switch off, and then open the hood. (→P. 497)

2 Open the AdBlue™ tank cap.

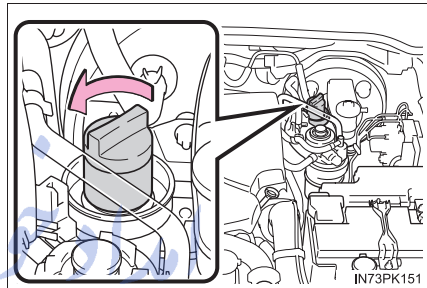

3 Insert the nozzle and refill AdBlue™.

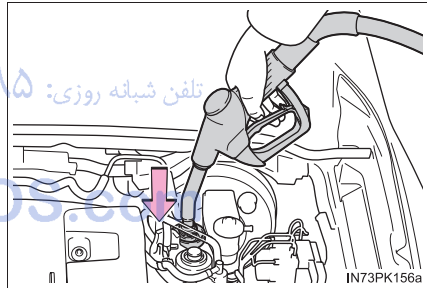

4 Close the AdBlue™ tank cap.

Turn the cap until you hear a click.

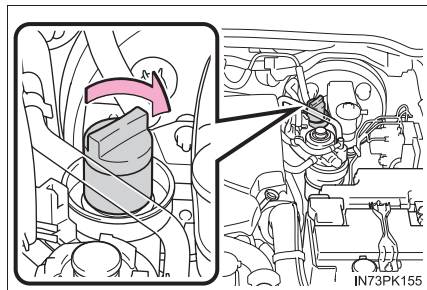

5 Check that the engine starts.

► Refilling with the bottle

- 1 Park the vehicle on a level surface, turn the engine switch off, and then open the hood. (→P. 497)
- 2 Open the AdBlue™ tank cap.

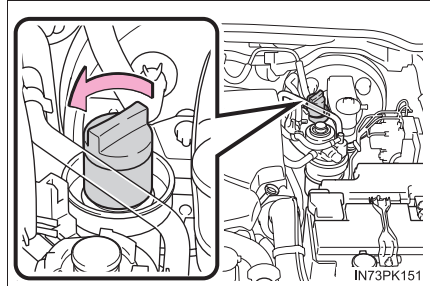

- 3 Insert a bottle of AdBlue™ and fully tighten it.

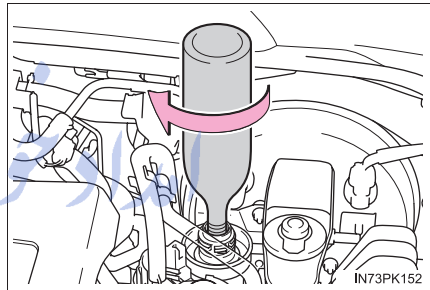

- 4 Push down on the bottle.

AdBlue™ will begin to be refilled. Refill AdBlue™ slowly so that it does not spill. Do not remove the bottle until it is empty.

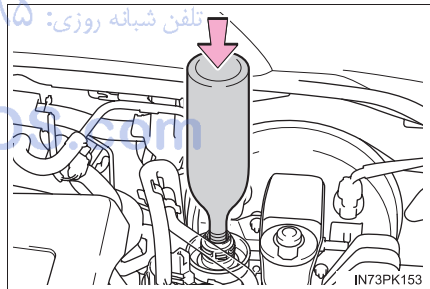

- 5 Check that no AdBlue™ remains in the bottle, and then remove it.

Repeat steps 3 to 5 until approximately 5.0 L (5.3 qt., 4.4 Imp.qt.) or more of AdBlue™ have been refilled.

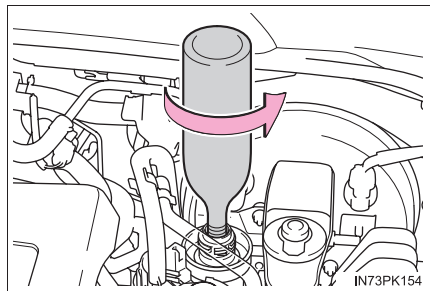

- 6 Close the AdBlue™ tank cap.
Turn the cap until you hear a click.

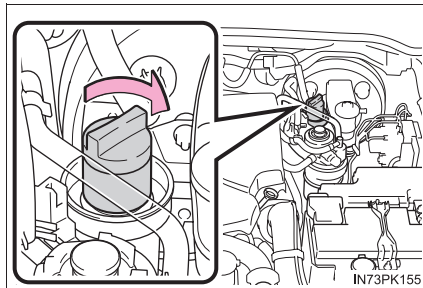

- 7 Check that the engine starts.

The way of refilling may differ from those shown in the illustration.

■ When refilling AdBlue™

After refilling AdBlue™, the engine may take a few seconds longer than normal to start.

⚠ NOTICE

■ When refilling AdBlue™

Observe the following precautions.

Failure to do so may result in damage to the vehicle parts, paint, etc.

- Do not use urea solution other than AdBlue™.
- If AdBlue™ comes into contact with any painted surfaces on the vehicle, immediately wash the affected areas with water.
- If AdBlue™ is spilled inside the engine compartment, immediately wipe it with a wet cloth.

■ When refilling AdBlue™ with the refilling equipment

Observe the following precautions to prevent AdBlue™ overflowing from the AdBlue™ tank:

- Securely insert the nozzle into the AdBlue™ filler neck.
- Stop filling the tank after the nozzle automatically clicks off.
- Do not top off the AdBlue™ tank.

■ When storing AdBlue™ containers

Observe the following precautions.

Failure to do so may result in damage to vehicle parts, paint, etc., and changes in the chemical compounds of AdBlue™ may cause unpleasant odors.

- Do not leave AdBlue™ containers inside the vehicle.
- Tightly seal AdBlue™ containers and store them in a cool, dry location with good ventilation and no exposure to direct sunlight.

Tires

Replace or rotate tires in accordance with maintenance schedules and treadwear.

Checking tires

Check if the treadwear indicators are showing on the tires. Also check the tires for uneven wear, such as excessive wear on one side of the tread.

Check the spare tire condition and pressure if not rotated.

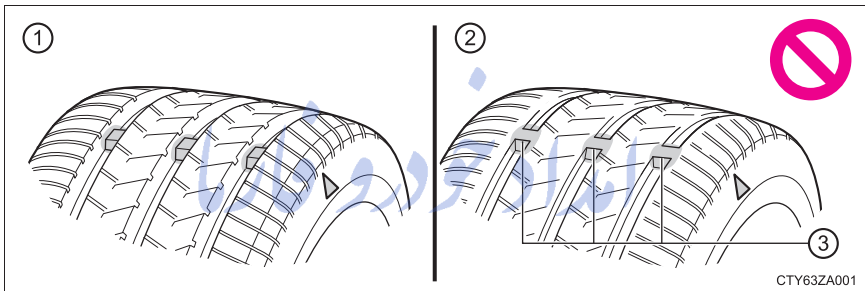

① New tread

② Worn tread

③ Treadwear indicator

The location of treadwear indicators is shown by a "TWI" or "Δ" mark, etc., molded into the sidewall of each tire.

Replace the tires if the treadwear indicators are showing on a tire.

Tire rotation

Rotate the tires in the order shown.

- ▶ Vehicles with spare tire of a different wheel type from the installed tires
- ▶ Vehicles with spare tire of the same wheel type as the installed tires

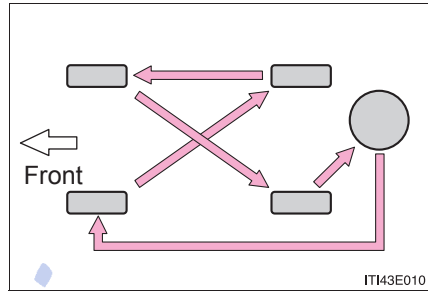
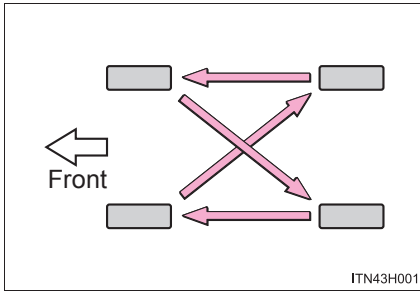

To equalize tire wear and help extend tire life, Toyota recommends that tire rotation is carried out approximately every 10000 km (6000 miles).

Do not fail to initialize the tire pressure warning system after tire rotation. (vehicles with tire pressure warning system)

Tire pressure warning system (if equipped)

Your vehicle is equipped with a tire pressure warning system that uses tire pressure warning valves and transmitters to detect low tire inflation pressure before serious problems arise.

If the tire pressure drops below a predetermined level, the driver is warned by a warning light. (→P. 572)

◆ Installing tire pressure warning valves and transmitters

When replacing tires or wheels, tire pressure warning valves and transmitters must also be installed.

When new tire pressure warning valves and transmitters are installed, new ID codes must be registered in the tire pressure warning computer and the tire pressure warning system must be initialized. Have tire pressure warning valves and transmitter ID codes registered by any authorized Toyota dealer or repairer, or another duly qualified and equipped professional. (→P. 521)

◆ Initializing the tire pressure warning system

■ The tire pressure warning system must be initialized in the following circumstances:

- When the tire inflation pressure is changed such as when changing traveling speed or load weight.
- When the tire inflation pressure is changed such as when the tire size is changed.
- When rotating the tires.

When the tire pressure warning system is initialized, the current tire inflation pressure is set as the benchmark pressure.

■ How to initialize the tire pressure warning system

1 Vehicles without smart entry & start system:

Park the vehicle in a safe place and turn the engine switch to the "LOCK" position.

Vehicles with smart entry & start system:

Park the vehicle in a safe place and turn the engine switch off.

Initialization cannot be performed while the vehicle is moving.

2 Adjust the tire inflation pressure to the specified cold tire inflation pressure level. (→P. 642)

Make sure to adjust the tire pressure to the specified cold tire inflation pressure level. The tire pressure warning system will operate based on this pressure level.

3 Vehicles without smart entry & start system:

Turn the engine switch to the "ON" position.

Vehicles with smart entry & start system:

Turn the engine switch to IGNITION ON mode.

4 Press and hold the tire pressure warning reset switch until the tire pressure warning light blinks slowly 3 times.

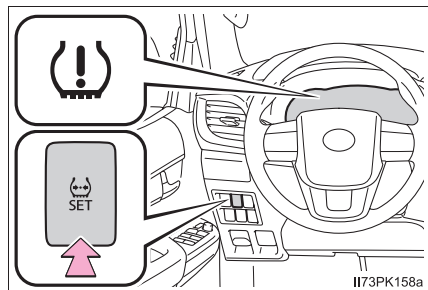

- 5 Vehicles without smart entry & start system: Wait for a few minutes with the engine switch in the “ON” position and then turn the engine switch to the “ACC” or “LOCK” position.

Vehicles with smart entry & start system: Wait for a few minutes with the engine switch in IGNITION ON mode and then turn the engine switch off.

◆ Registering ID codes

The tire pressure warning valve and transmitter is equipped with a unique ID code. When replacing a tire pressure warning valve and transmitter, it is necessary to register the ID code. Have the ID code registered by any authorized Toyota dealer or repairer, or another duly qualified and equipped professional.

■ When to replace your vehicle’s tires

Tires should be replaced if:

- The treadwear indicators are showing on a tire.
- You have tire damage such as cuts, splits, cracks deep enough to expose the fabric, and bulges indicating internal damage
- A tire goes flat repeatedly or cannot be properly repaired due to the size or location of a cut or other damage

If you are not sure, consult with any authorized Toyota dealer or repairer, or another duly qualified and equipped professional.

■ Replacing tires and wheels (vehicles with tire pressure warning system)

If the ID code of the tire pressure warning valve and transmitter is not registered, the tire pressure warning system will not work properly. After driving for about 10 minutes, the tire pressure warning light blinks for 1 minute and stays on to indicate a system malfunction.

■ Tire life

Any tire over 6 years old must be checked by a qualified technician even if it has seldom or never been used or damage is not obvious.

■ Routine tire inflation pressure checks (vehicles with tire pressure warning system)

The tire pressure warning system does not replace routine tire inflation pressure checks. Make sure to check tire inflation pressure as part of your routine of daily vehicle checks.

■ **Initializing the tire pressure warning system (vehicles with tire pressure warning system)**

Initialize the system with the tire inflation pressure adjusted to the specified level.

■ **If the tread on snow tires wears down below 4 mm (0.16 in.)**

The effectiveness of the tires as snow tires is lost.

■ **If you press the tire pressure warning reset switch accidentally (vehicles with tire pressure warning system)**

If initialization is performed, adjust the tire inflation pressure to the specified level and initialize the tire pressure warning system again.

■ **Situations in which the tire pressure warning system may not operate properly (vehicles with tire pressure warning system)**

- In the following cases, the tire pressure warning system may not operate properly.
 - If non-genuine Toyota wheels are used.
 - A tire has been replaced with a tire that is not an OE (Original Equipment) tire.
 - A tire has been replaced with a tire that is not of the specified size.
 - Tire chains etc. are equipped.
 - If a window tint that affects the radio wave signals is installed.
 - If there is a lot of snow or ice on the vehicle, particularly around the wheels or wheel housings.
 - If the tire inflation pressure is extremely higher than the specified level.
 - If tires not equipped with tire pressure warning valves and transmitters are used.
 - If the ID code on the tire pressure warning valves and transmitters is not registered in the tire pressure warning computer.
 - If the spare tire is in a location subject to poor radio wave signal reception.
 - If a large metallic object which can interfere with signal reception is put near the spare tire.
- Performance may be affected in the following situations.
 - Near a TV tower, electric power plant, gas station, radio station, large display, airport or other facility that generates strong radio waves or electrical noise
 - When carrying a portable radio, cellular phone, cordless phone or other wireless communication device
- When the vehicle is parked, the time taken for the warning to start or go off could be extended.
- When tire inflation pressure declines rapidly for example when a tire has burst, the warning may not function.

■ The initialization operation (vehicles with tire pressure warning system)

- Make sure to carry out initialization after adjusting the tire inflation pressure. Also, make sure the tires are cold before carrying out initialization or tire inflation pressure adjustment.
- If you have accidentally turned the engine switch to the “LOCK” position (vehicles without smart entry & start system) or off (vehicles with smart entry & start system) during initialization, it is not necessary to press the reset switch again as initialization will restart automatically when the engine switch has been turned to the “ON” position (vehicles without smart entry & start system) or IGNITION ON mode (vehicles with smart entry & start system) for the next time.
- If you accidentally press the reset switch when initialization is not necessary, adjust the tire inflation pressure to the specified level when the tires are cold, and conduct initialization again.

■ When initialization of the tire pressure warning system has failed (vehicles with tire pressure warning system)

Initialization can be completed in a few minutes. However, in the following cases, the settings have not been recorded and the system will not operate properly. If repeated attempts to record tire inflation pressure settings are unsuccessful, have the vehicle inspected by any authorized Toyota dealer or repairer, or another duly qualified and equipped professional.

- When operating the tire pressure warning reset switch, the tire pressure warning light does not blink 3 times.
- After driving for a certain period of time since the initialization has been completed, the warning light stays on after blinking for 1 minute.

■ Warning performance of the tire pressure warning system (vehicles with tire pressure warning system)

The warning of the tire pressure warning system will change in accordance with the conditions under which it was initialized. For this reason, the system may give a warning even if the tire pressure does not reach a low enough level, or if the pressure is higher than the pressure that was adjusted to when the system was initialized.

■ Certification for tire pressure warning system

43514/SDPPI/2015
3505

⚠ WARNING**■ When inspecting or replacing tires**

Observe the following precautions to prevent accidents.

Failure to do so may cause damage to parts of the drive train as well as dangerous handling characteristics, which may lead to an accident resulting in death or serious injury.

- Do not mix tires of different makes, models or tread patterns.
Also, do not mix tires of remarkably different treadwear.
- Do not use tire sizes other than those recommended by Toyota.
- Do not mix differently constructed tires (radial, bias-belted or bias-ply tires).
- Do not mix summer, all season and snow tires.
- Do not use tires that have been used on another vehicle.
Do not use tires if you do not know how they were used previously.

■ When initializing the tire pressure warning system (vehicles with tire pressure warning system)

Do not operate the tire pressure warning reset switch without first adjusting the tire inflation pressure to the specified level. Otherwise, the tire pressure warning light may not come on even if the tire inflation pressure is low, or it may come on when the tire inflation pressure is actually normal.

FarmaSOS.com

 NOTICE

■ **Repairing or replacing tires, wheels, tire pressure warning valves, transmitters and tire valve caps (vehicles with tire pressure warning system)**

- When removing or fitting the wheels, tires or the tire pressure warning valves and transmitters, contact any authorized Toyota dealer or repairer, or another duly qualified and equipped professional as the tire pressure warning valves and transmitters may be damaged if not handled correctly.
- Make sure to install the tire valve caps. If the tire valve caps are not installed, water could enter the tire pressure warning valves and the tire pressure warning valves could be bound.
- When replacing tire valve caps, do not use tire valve caps other than those specified. The cap may become stuck.

■ **To avoid damage to the tire pressure warning valves and transmitters (vehicles with tire pressure warning system)**

When a tire is repaired with liquid sealants, the tire pressure warning valve and transmitter may not operate properly. If a liquid sealant is used, contact any authorized Toyota dealer or repairer, or another duly qualified and equipped professional or other qualified service shop as soon as possible. After use of liquid sealant, make sure to replace the tire pressure warning valve and transmitter when repairing or replacing the tire. (→P. 519)

■ **Driving on rough roads**

Take particular care when driving on roads with loose surfaces or potholes. These conditions may cause losses in tire inflation pressure, reducing the cushioning ability of the tires. In addition, driving on rough roads may cause damage to the tires themselves, as well as the vehicle's wheels and body.

■ **If tire inflation pressure of each tire becomes low while driving**

Do not continue driving, or your tires and/or wheels may be ruined.

Tire inflation pressure

Make sure to maintain proper tire inflation pressure. Tire inflation pressure should be checked at least once per month. However, Toyota recommends that tire inflation pressure be checked once every two weeks. (→P. 642)

■ Effects of incorrect tire inflation pressure

Driving with incorrect tire inflation pressure may result in the following:

- Reduced fuel economy
- Reduced driving comfort and poor handling
- Reduced tire life due to wear
- Reduced safety
- Damage to the drive train

If a tire needs frequent inflating, have it checked by any authorized Toyota dealer or repairer, or another duly qualified and equipped professional.

■ Instructions for checking tire inflation pressure

When checking tire inflation pressure, observe the following:

- Check only when the tires are cold.
If your vehicle has been parked for at least 3 hours or has not been driven for more than 1.5 km or 1 mile, you will get an accurate cold tire inflation pressure reading.
- Always use a tire pressure gauge.
It is difficult to judge if a tire is properly inflated based only on its appearance.
- It is normal for the tire inflation pressure to be higher after driving as heat is generated in the tire. Do not reduce tire inflation pressure after driving.
- Passengers and luggage weight should be placed so that the vehicle is balanced.

 **WARNING****■ Proper inflation is critical to save tire performance**

Keep your tires properly inflated.

If the tires are not properly inflated, the following conditions may occur which could lead to an accident resulting in death or serious injury:

- Excessive wear
- Uneven wear
- Poor handling
- Possibility of blowouts resulting from overheated tires
- Air leaking from between tire and wheel
- Wheel deformation and/or tire damage
- Greater possibility of tire damage while driving (due to road hazards, expansion joints, sharp edges in the road, etc.)

 **NOTICE****■ When inspecting and adjusting tire inflation pressure**

Be sure to put the tire valve caps back on.

If a valve cap is not installed, dirt or moisture may get into the valve and cause an air leak, resulting in decreased tire inflation pressure.

تلفن شبانه روزی: +۸۵ ۸۸۸۶۲ ۲۱

FarmaSOS.com

Wheels

If a wheel is bent, cracked or heavily corroded, it should be replaced. Otherwise, the tire may separate from the wheel or cause a loss of handling control.

Wheel selection

When replacing wheels, care should be taken to ensure that they are equivalent to those removed in load capacity, diameter, rim width and inset*.

Replacement wheels are available at any authorized Toyota dealer or repairer, or another duly qualified and equipped professional.

*: Conventionally referred to as "offset".

Toyota does not recommend using the following:

- Wheels of different sizes or types
- Used wheels
- Bent wheels that have been straightened

Aluminum wheel precautions (if equipped)

- Use only Toyota wheel nuts and wrenches designed for use with your aluminum wheels.
- When rotating, repairing or changing your tires, check that the wheel nuts are still tight after driving 1600 km (1000 miles).
- Be careful not to damage the aluminum wheels when using tire chains.
- Use only Toyota genuine balance weights or equivalent and a plastic or rubber hammer when balancing your wheels.

■ When replacing wheels (vehicles with tire pressure warning system)

The wheels of your vehicle are equipped with tire pressure warning valves and transmitters that allow the tire pressure warning system to provide advance warning in the event of a loss in tire inflation pressure. Whenever wheels are replaced, tire pressure warning valves and transmitters must be installed. (→P. 519)

 **WARNING**

■ **When replacing wheels**

- Do not use wheels that are a different size from those recommended in the Owner's Manual, as this may result in a loss of handling control.
- Never use an inner tube in a leaking wheel which is designed for a tubeless tire. Doing so may result in an accident, causing death or serious injury.

■ **When installing the wheel nuts**

- Be sure to install the wheel nuts with the tapered ends facing inward. Installing the nuts with the tapered ends facing outward can cause the wheel to break and eventually cause the wheel to come off while driving, which could lead to an accident resulting in death or serious injury.

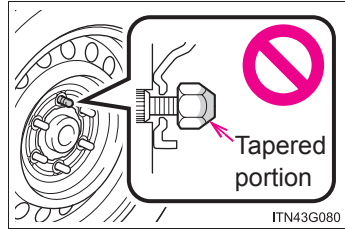

- Never use oil or grease on the wheel bolts or wheel nuts. Oil and grease may cause the wheel nuts to be excessively tightened, leading to bolt or disc wheel damage. In addition, the oil or grease can cause the wheel nuts to loosen and the wheel may fall off, causing an accident and resulting in death or serious injury. Remove any oil or grease from the wheel bolts or wheel nuts.

■ **Use of defective wheels prohibited** تلفن شبانه روزی: ۸۵

Do not use cracked or deformed wheels.

Doing so could cause the tire to leak air during driving, possibly causing an accident.

FarmaSOS.com

 **NOTICE**

■ **Replacing tire pressure warning valves and transmitters (vehicles with tire pressure warning system)**

- Because tire repair or replacement may affect the tire pressure warning valves and transmitters, make sure to have tires serviced by any authorized Toyota dealer or repairer, or another duly qualified and equipped professional or other qualified service shop. In addition, make sure to purchase your tire pressure warning valves and transmitters at any authorized Toyota dealer or repairer, or another duly qualified and equipped professional.
- Ensure that only genuine Toyota wheels are used on your vehicle. Tire pressure warning valves and transmitters may not work properly with non-genuine wheels.

Air conditioning filter

The air conditioning filter must be changed regularly to maintain air conditioning efficiency.

Removal method

- 1 Vehicles without smart entry & start system: Turn the engine switch to the "LOCK" position.
Vehicles with smart entry & start system: Turn the engine switch off.
- 2 Open the glove box. Turn the claws as shown in the illustration.

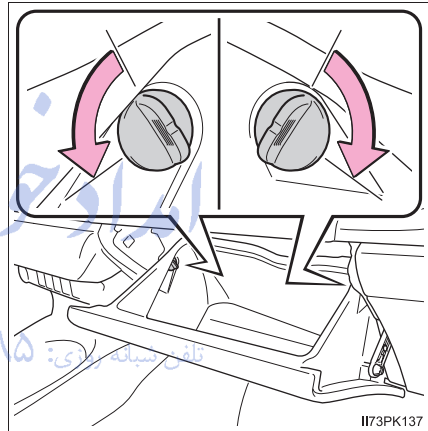

- 3 Pull out the claws.

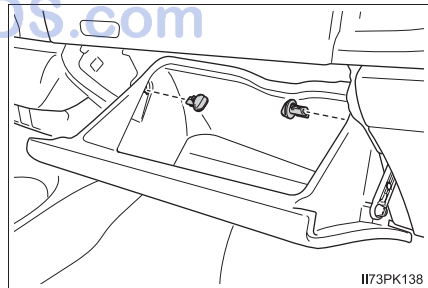

- 4 Pull out the damper (if equipped) as shown in the illustration, and then remove the glove box.

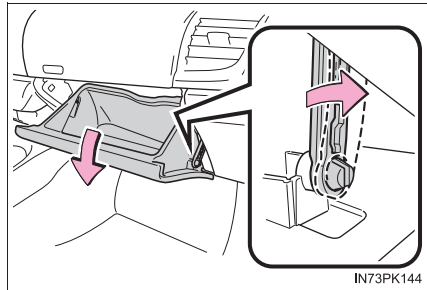

- 5 Remove the filter cover.

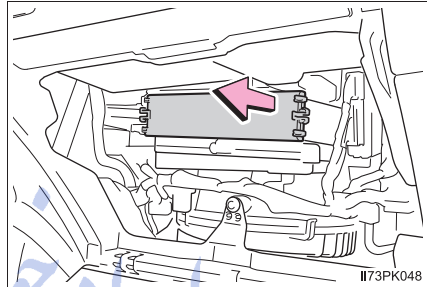

- 6 Remove the air conditioning filter and replace it with a new one.

The “↑UP” marks shown on the filter should be pointing up.

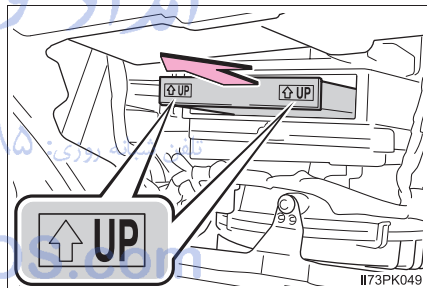

■ Changing interval

Inspect and replace the air conditioning filter according to the maintenance schedule. In dusty areas or areas with heavy traffic flow, early replacement may be required. (For scheduled maintenance information, please refer to the “Toyota Service Booklet” or “Toyota Warranty Booklet”.)

■ If air flow from the vents decreases dramatically

The filter may be clogged. Check the filter and replace if necessary.

⚠ NOTICE

■ When using the air conditioning system

Make sure that a filter is always installed.

Using the air conditioning system without a filter may cause damage to the system.

Wireless remote control/electronic key battery*

Replace the battery with a new one if it is depleted.

You will need the following items:

- Flathead screwdriver
- Small flathead screwdriver
- Lithium battery

Vehicles without smart entry & start system: CR1620

Vehicles with smart entry & start system: CR2032

Replacing the battery

► Vehicles without smart entry & start system

1 Remove the cover.

To prevent damage to the key, cover the tip of the screwdriver with a rag.

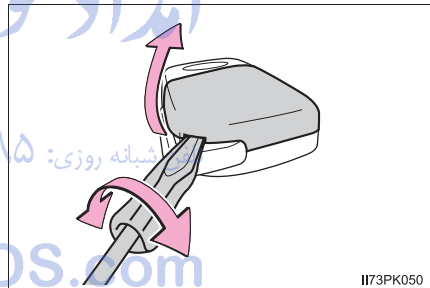

2 Remove the battery cover.

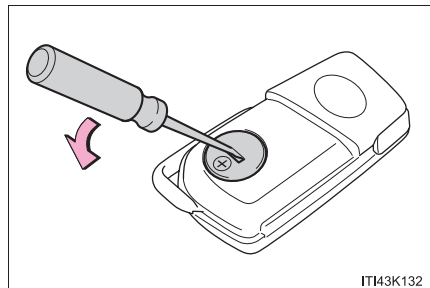

*: If equipped

- 3 Remove the depleted battery.
Insert a new battery with the “+” terminal facing up.

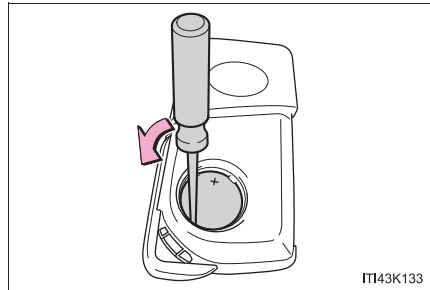

► Vehicles with smart entry & start system

- 1 Take out the mechanical key.

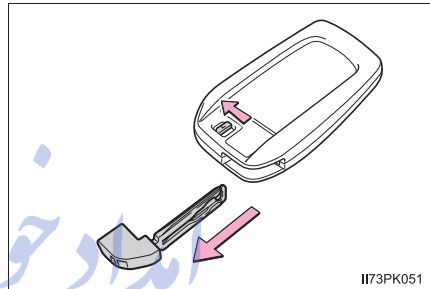

- 2 Remove the cover.

To prevent damage to the key, cover the tip of the screwdriver with a rag.

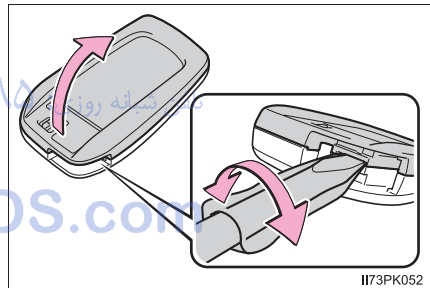

- 3 Remove the depleted battery.
Insert a new battery with the “+” terminal facing up.

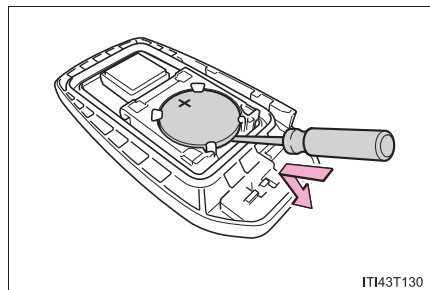

■ Use a lithium battery

Vehicles without smart entry & start system: CR1620

Vehicles with smart entry & start system: CR2032

- Batteries can be purchased at any authorized Toyota dealer or repairer, or another duly qualified and equipped professional, local electrical appliance shops or camera stores.
- Replace only with the same or equivalent type recommended by the manufacturer.
- Dispose of used batteries according to local laws.

■ If the key battery is depleted

The following symptoms may occur:

- The smart entry & start system (if equipped) and wireless remote control will not function properly.
- The operational range will be reduced.

⚠ WARNING

■ Removed battery and other parts

These parts are small and if swallowed by a child, they can cause choking. Keep away from children. Failure to do so could result in death or serious injury.

■ Certification for the key battery

CAUTION

RISK OF EXPLOSION IF BATTERY IS REPLACED BY AN INCORRECT TYPE. DISPOSE OF USED BATTERIES ACCORDING TO THE INSTRUCTIONS

⚠ NOTICE

■ For normal operation after replacing the battery

Observe the following precautions to prevent accidents:

- Always work with dry hands.
Moisture may cause the battery to rust.
- Do not touch or move any other component inside the remote control.
- Do not bend either of the battery terminals.

Checking and replacing fuses

If any of the electrical components do not operate, a fuse may have blown. If this happens, check and replace the fuses as necessary.

- 1 Vehicles without smart entry & start system:
Turn the engine switch to the "LOCK" position.
Vehicles with smart entry & start system:
Turn the engine switch off.

- 2 Open the fuse box cover.

- ▶ In the engine compartment

Push the tab in and pull the lock release, and lift the lid off.

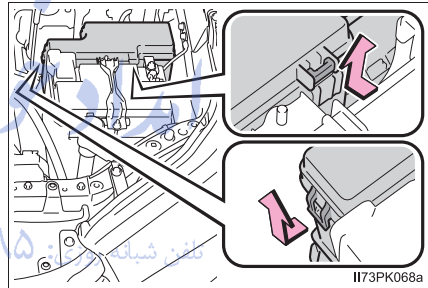

- ▶ Under the instrument panel (left-hand drive vehicles)

Remove the lid.

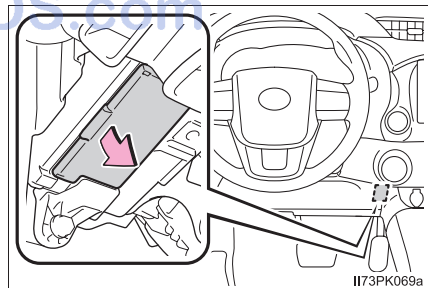

► Under the instrument panel (right-hand drive vehicles)

Remove the cover (if equipped).

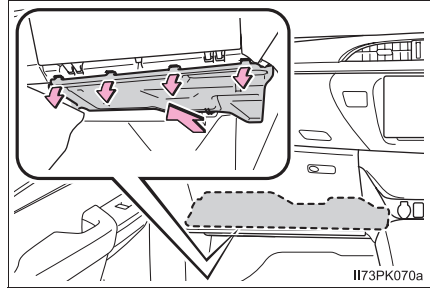

Remove the lid.

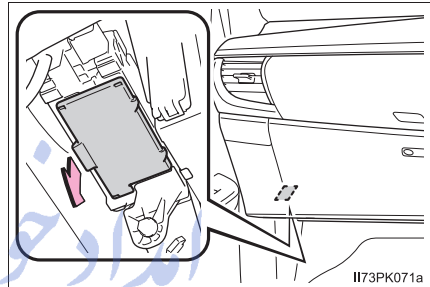

► Behind the instrument panel (left-hand drive vehicles)

Remove the glove box
(→P. 530), and remove the lid.

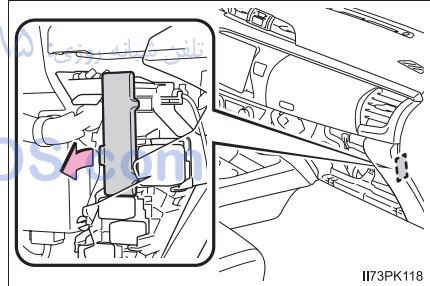

► Behind the instrument panel (right-hand drive vehicles)

Remove the glove box
(→P. 530), and remove the lid.

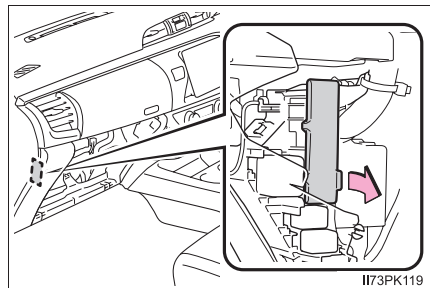

► Behind the cowl side panel

Remove the driver's door scuff plate (left-hand drive vehicles) or the front passenger's door scuff plate (right-hand drive vehicles).

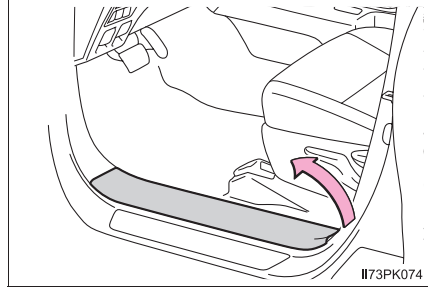

Remove the nut and the cowl side panel.

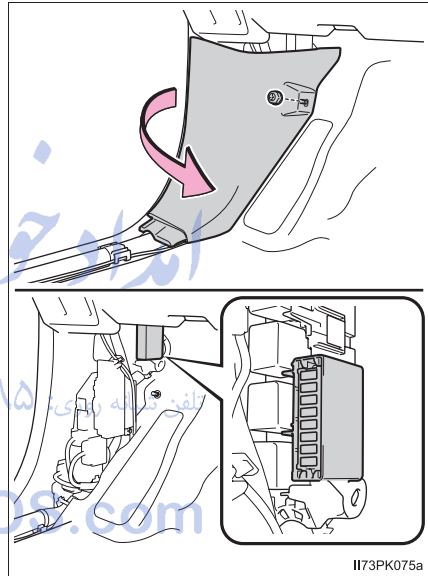

3 Remove the fuse.

Only type A fuse can be removed using the pullout tool.

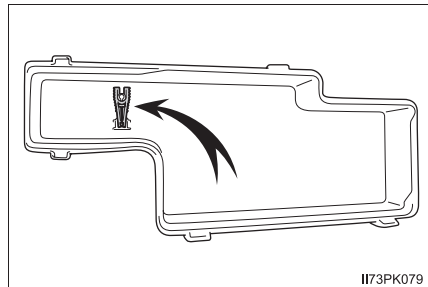

4 Check if the fuse is blown.

- ① Normal fuse
- ② Blown fuse

Type A, B, C and D:

Replace the blown fuse with a new fuse of an appropriate amperage rating. The amperage rating can be found on the fuse box lid.

Type E:

Contact any authorized Toyota dealer or repairer, or another duly qualified and equipped professional.

► Type A

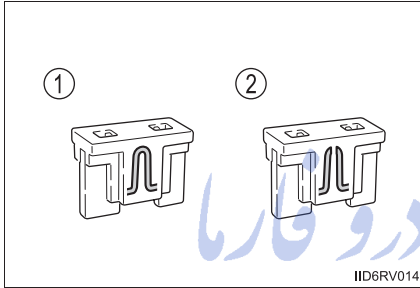

► Type B

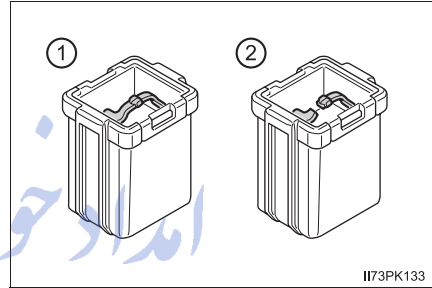

► Type C

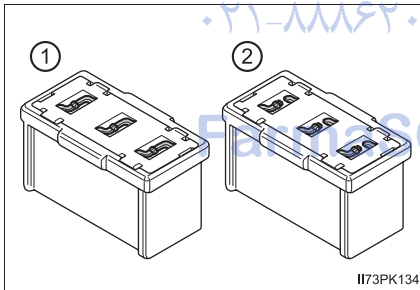

► Type D

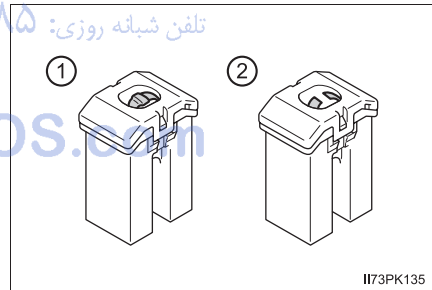

► Type E

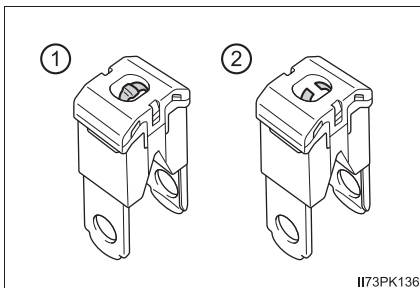

■ After a fuse is replaced

- If the lights do not turn on even after the fuse has been replaced, a bulb may need replacement. (→P. 540)
- If the replaced fuse blows again, have the vehicle inspected by any authorized Toyota dealer or repairer, or another duly qualified and equipped professional.

■ If there is an overload in a circuit

The fuses are designed to blow, protecting the wiring harness from damage.

WARNING

■ To prevent system breakdowns and vehicle fire

Observe the following precautions.

Failure to do so may cause damage to the vehicle, and possibly a fire or injury.

- Never use a fuse of a higher amperage rating than that indicated, or use any other object in place of a fuse.
- Always use a genuine Toyota fuse or equivalent.
Never replace a fuse with a wire, even as a temporary fix.
- Do not modify the fuses or fuse boxes.

NOTICE

■ Before replacing fuses

Have the cause of electrical overload determined and repaired by any authorized Toyota dealer or repairer, or another duly qualified and equipped professional as soon as possible.

Light bulbs

You may replace the following bulbs by yourself. The difficulty level of replacement varies depending on the bulb. As there is a danger that components may be damaged, we recommend that replacement is carried out by any authorized Toyota dealer or repairer, or another duly qualified and equipped professional.

Preparing for light bulb replacement

Check the wattage of the light bulb to be replaced. (→P. 644)

Bulb locations

■ Front

▶ Vehicles with halogen headlights

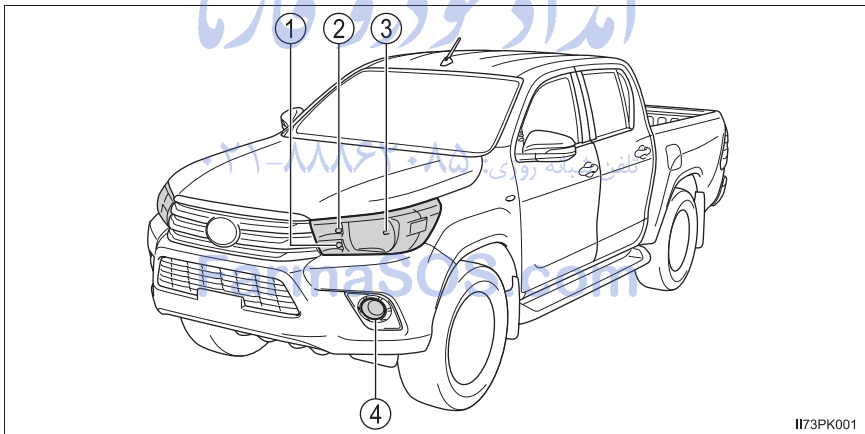

- | | |
|---|--------------------|
| ① Front turn signal light | ③ Headlight |
| ② Front position light/daytime running light* | ④ Front fog light* |

*: If equipped

1173PK001

► Vehicles with LED headlights

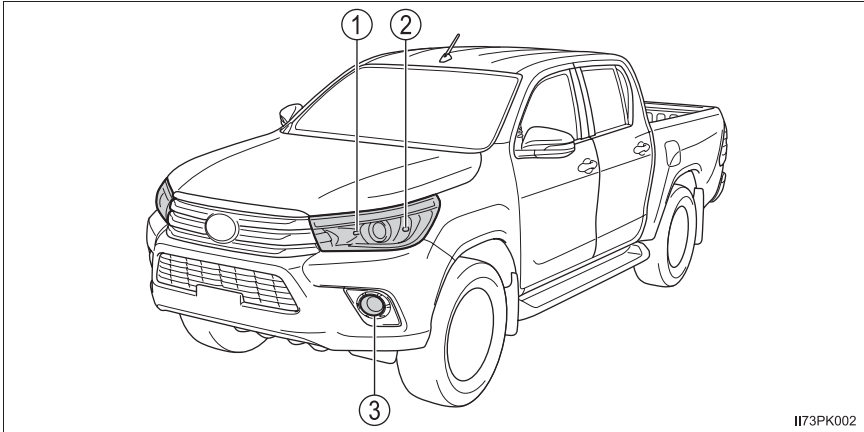

I173PK002

① Headlight (high beam)

③ Front fog light

② Front turn signal light

■ Rear

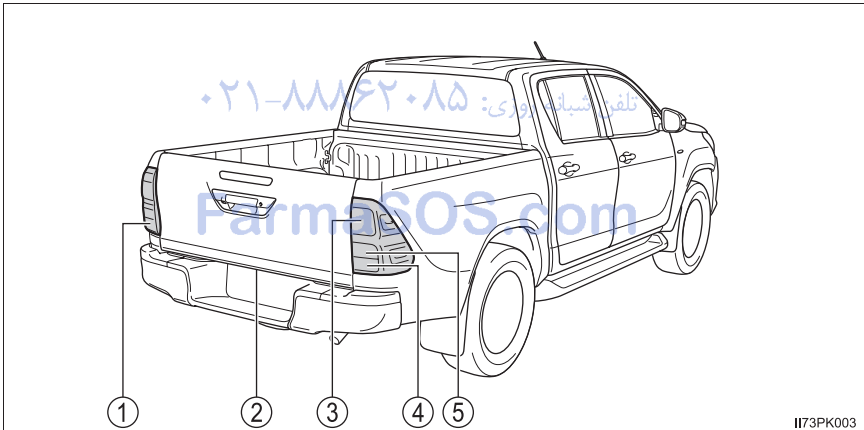

I173PK003

① Rear fog light*
(left-hand drive vehicles)
or back-up light

④ Rear fog light*
(right-hand drive vehicles)
or back-up light

② License plate light

⑤ Rear turn signal light

③ Stop/tail light

*: If equipped

Replacing light bulbs

■ Headlight high/low beams (vehicles with halogen headlights)

- 1 Unplug the connector and remove the rubber cover.

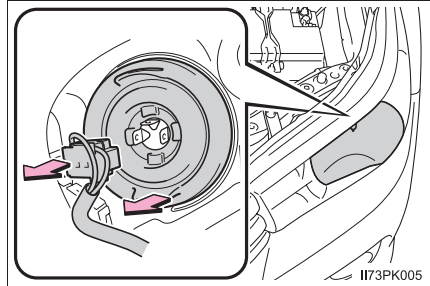

- 2 Release the bulb retaining spring.

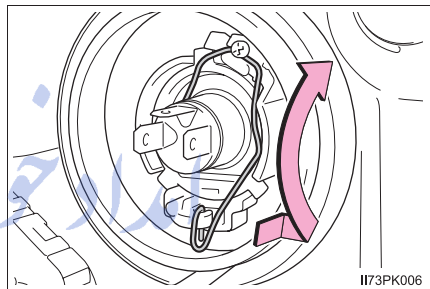

- 3 Remove the bulb.

To install a new bulb, align the tabs of the bulb with the cutouts of the mounting hole.

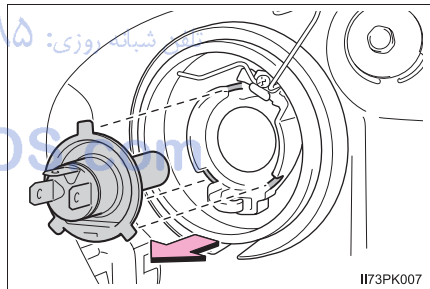

- 4 When installing, reverse the steps listed.

■ Headlight high beams (vehicles with LED headlights)

- 1 Unplug the connector while depressing the lock release.

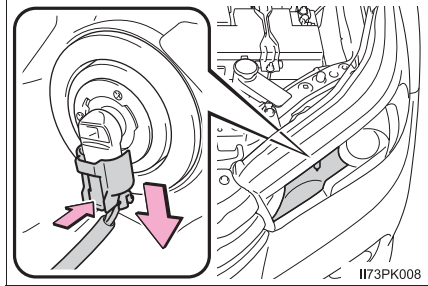

- 2 Turn the bulb base counter-clockwise.

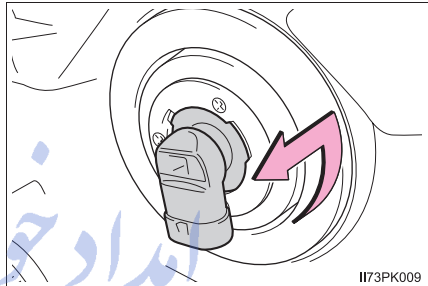

- 3 Replace the light bulb, and install the bulb base.

Align the 3 tabs on the light bulb with the mounting, and insert.

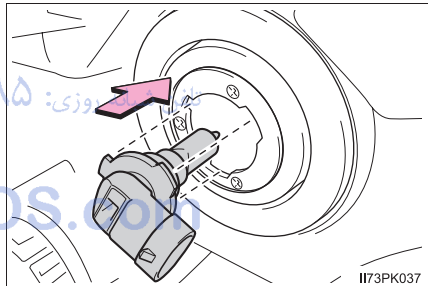

- 4 Turn and secure the bulb base.

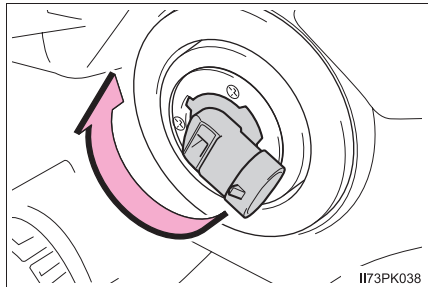

5 Install the connector

Shake the bulb base gently to check that it is not loose, turn the headlight high beams on once and visually confirm that no light is leaking through the mounting.

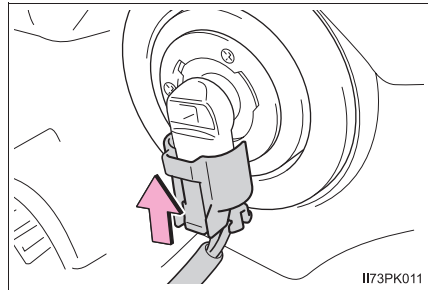

■ **Front position lights/daytime running lights (if equipped) (vehicles with halogen headlights)**

1 Turn the bulb base counterclockwise.

▶ Vehicles without daytime running lights

▶ Vehicles with daytime running lights

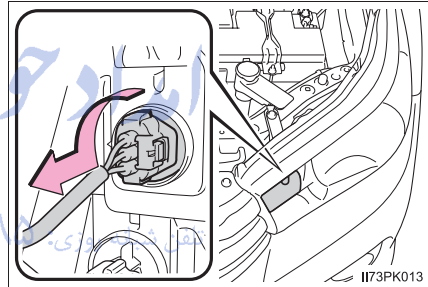
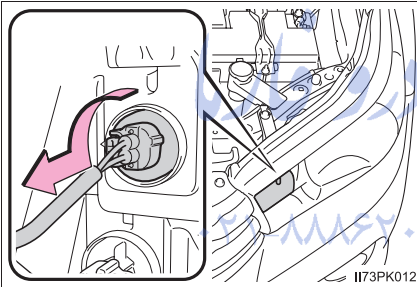

2 Remove the light bulb.

▶ Vehicles without daytime running lights

▶ Vehicles with daytime running lights

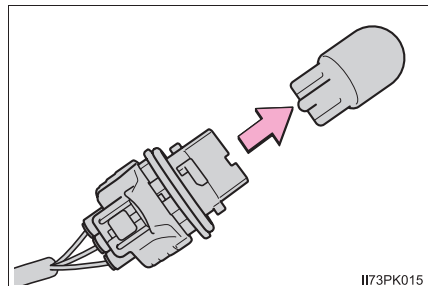
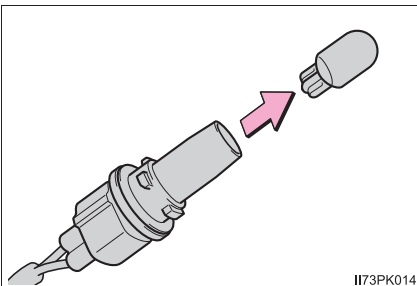

3 When installing, reverse the steps listed.

■ Front turn signal lights

▶ Vehicles with halogen headlights

- 1 Turn the bulb base counter-clockwise.

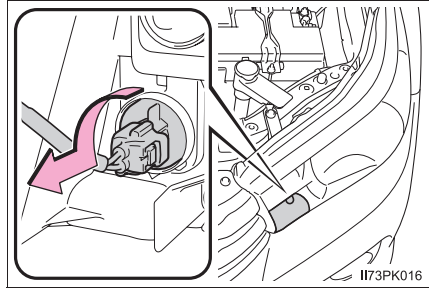

- 2 Remove the light bulb.

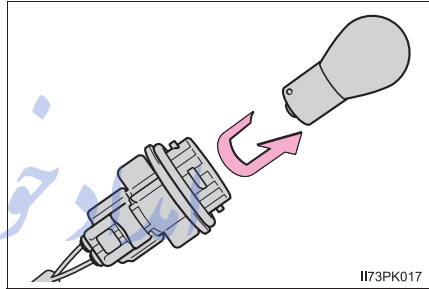

- 3 When installing, reverse the steps listed.

تلفن شبانه روزی: ۰۲۱-۸۸۸۶۲۰۸۵

FarmaSOS.com

► Vehicles with LED headlights

- 1 To allow enough working space, turn the steering wheel to the opposite side where the bulb to be replaced is located.

Remove the screws and clips.

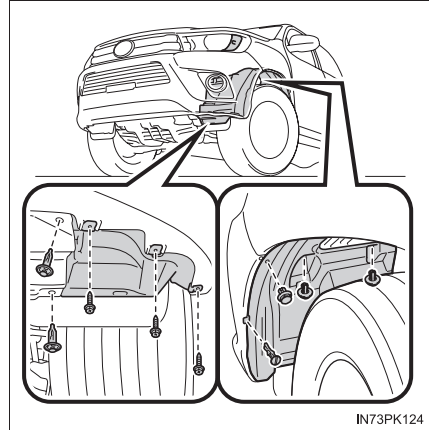

IN73PK124

① Removing the clip

② Installing the clip

► Type A

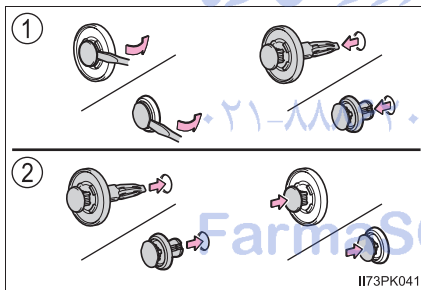

II73PK041

► Type B

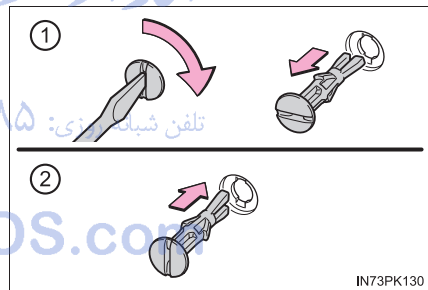

IN73PK130

- 2 Partly remove the fender liner and turn the bulb base counterclockwise.

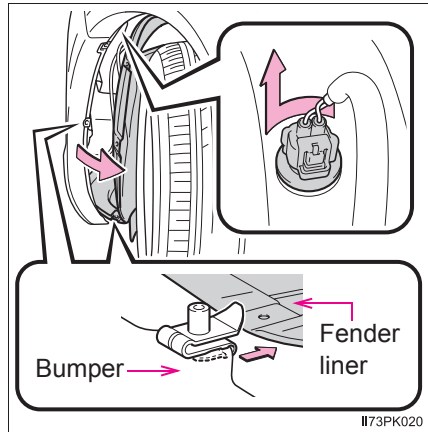

- 3 Remove the light bulb.

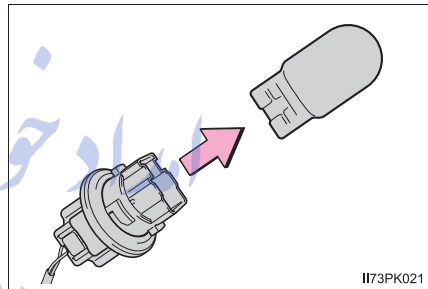

- 4 When installing, reverse the steps listed. تلفن شبكه ۰۲۱-۸۸۸۶۲۰۸۸

FarmaSOS.com

■ Front fog lights (if equipped)

- 1 To allow enough working space, turn the steering wheel to the opposite side where the bulb to be replaced is located.

Remove the screws and clips.

► Vehicles without steel bumper

► Vehicles with steel bumper

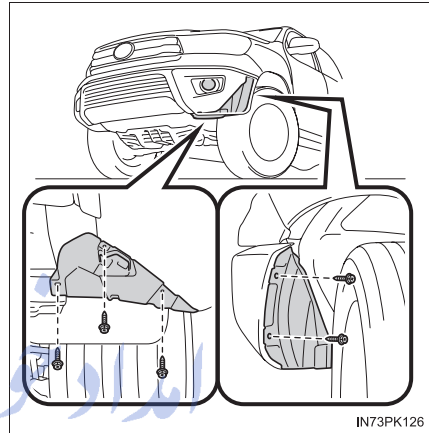
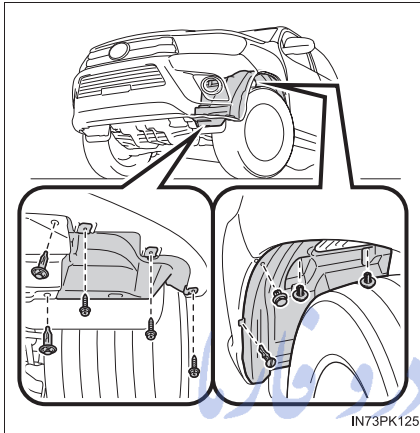

① Removing the clip

② Installing the clip

► Type A

► Type B

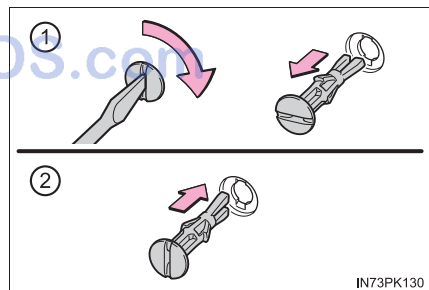
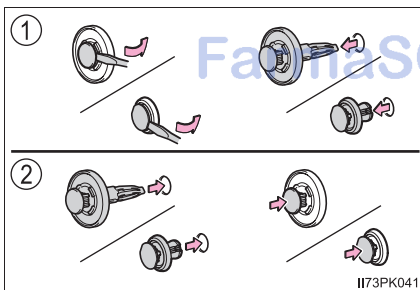

- 2 Partly remove the fender liner and unplug the connector while pressing the lock release.

► Vehicles without steel bumper

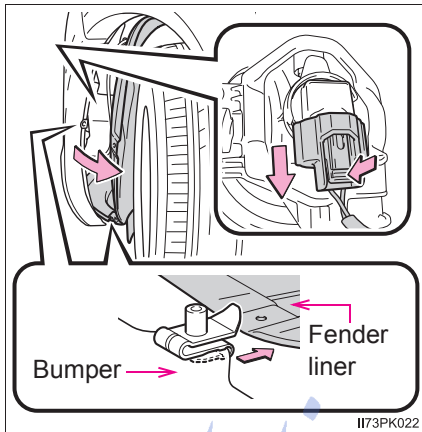

► Vehicles with steel bumper

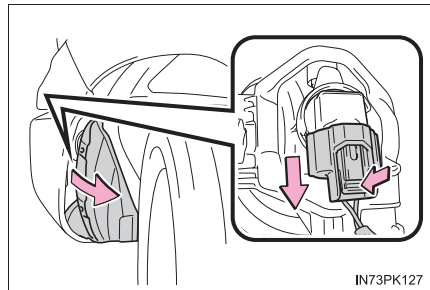

- 3 Turn the bulb base counter-clockwise.

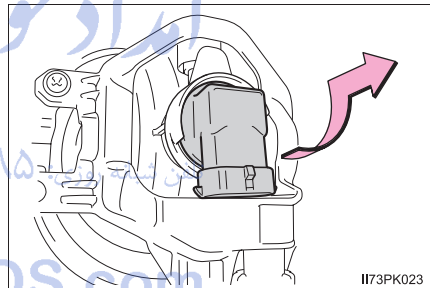

- 4 Replace the light bulb, and install the bulb base.

Align the 3 tabs on the light bulb with the mounting, and insert.

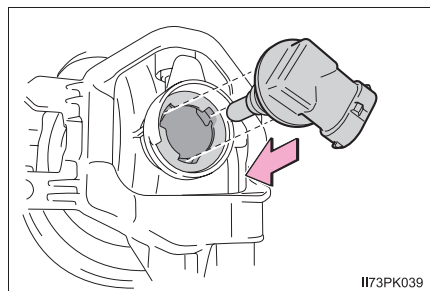

- 5 Turn and secure the bulb base.

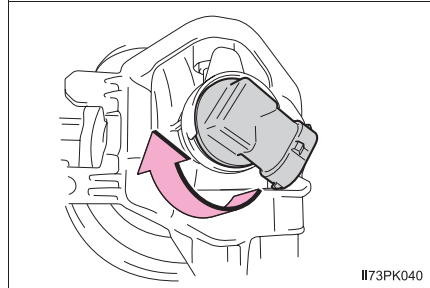

- 6 Install the connector

Shake the bulb base gently to check that it is not loose, turn the front fog lights on once and visually confirm that no light is leaking through the mounting.

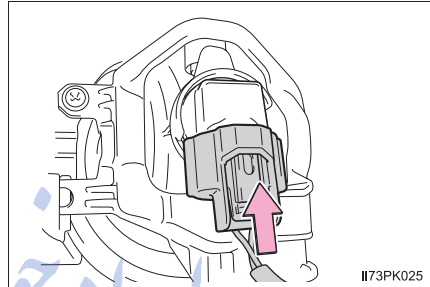

- 7 When installing the fender liner, screws and clips, reverse the removing procedure in steps 1 and 2.

تلفن شبانه روزی: ۰۲۱-۸۸۸۶۲۰۸۵

FarmaSOS.com

■ Stop/tail lights, rear turn signal lights and back-up lights or rear fog light (if equipped)

- 1 Remove the securing bolts and pull the unit sideways to remove.

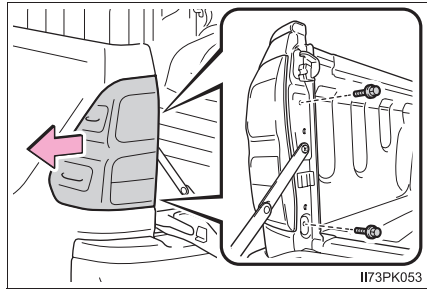

- 2 Turn the bulb base counter-clockwise.

- ① Stop/tail light
- ② Rear turn signal light
- ③ Back-up light or rear fog light

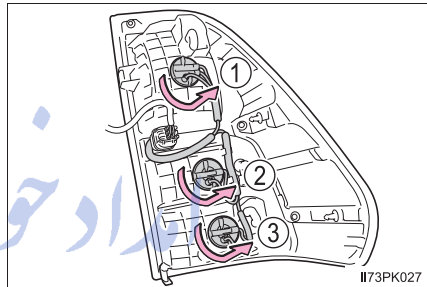

- 3 Remove the light bulb.

- ① Stop/tail light
- ② Rear turn signal light
- ③ Back-up light or rear fog light

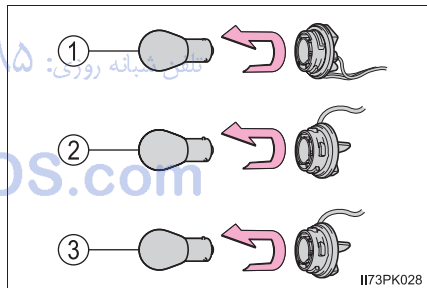

- 4 When installing, reverse the steps listed.

■ License plate light

- 1 Remove the unit.

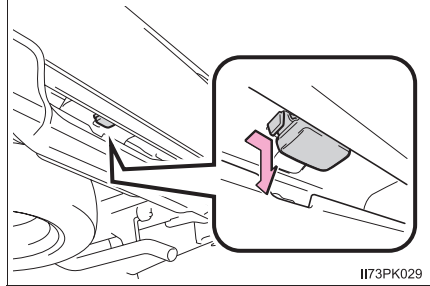

- 2 Turn the bulb base counter-clockwise.

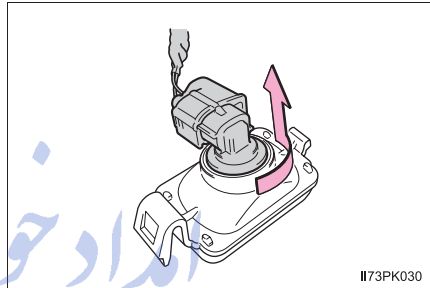

- 3 Remove the light bulb.

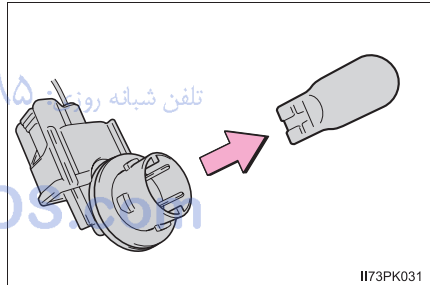

- 4 When installing, reverse the steps listed.

■ Replacing the following bulbs

If any of the lights listed below has burnt out, have it replaced by any authorized Toyota dealer or repairer, or another duly qualified and equipped professional.

- Headlight low beams (vehicles with LED headlights)
- Front position lights/daytime running lights (vehicles with LED headlights)
- Side turn signal lights
- High mounted stoplight (if equipped)

■ When installing the rubber cover of the headlight (vehicles with halogen headlights)

Ensure the rubber cover is securely attached.

- ① Fit the rubber cover outer circumference in firmly.
- ② Fit the rubber cover around the light bulb in until the light bulb plug can be seen.

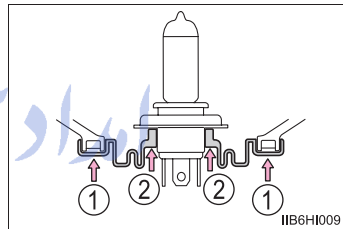

■ LED lights

The headlight low beams (vehicles with LED headlights), front position lights/daytime running lights (vehicles with LED headlights), side turn signal lights (mirror mounted type) and high mounted stoplight (if equipped) consists of a number of LEDs. If any of the LEDs burn out, take your vehicle to any authorized Toyota dealer or repairer, or another duly qualified and equipped professional to have the light replaced.

■ Condensation build-up on the inside of the lens

Temporary condensation build-up on the inside of the headlight lens does not indicate a malfunction. Contact any authorized Toyota dealer or repairer, or another duly qualified and equipped professional for more information in the following situations:

- Large drops of water have built up on the inside of the lens.
- Water has built up inside the headlight.

**WARNING****■ Replacing light bulbs**

- Turn off the lights. Do not attempt to replace the bulb immediately after turning off the lights.

The bulbs become very hot and may cause burns.

- Do not touch the glass portion of the light bulb with bare hands. When it is unavoidable to hold the glass portion, use and hold with a clean dry cloth to avoid getting moisture and oils on the bulb.

Also, if the bulb is scratched or dropped, it may blow out or crack.

- Fully install light bulbs and any parts used to secure them. Failure to do so may result in heat damage, fire, or water entering the headlight unit. This may damage the headlights or cause condensation to build up on the lens.

- Do not attempt to repair or disassemble light bulbs, connectors, electric circuits or component parts.

Doing so may result in death or serious injury due to electric shock.

■ To prevent damage or fire

- Make sure bulbs are fully seated and locked.
- Check the wattage of the bulb before installing to prevent heat damage.

تلفن شبانه روزی: ۰۲۱-۸۸۸۶۲۰۸۵

FarmaSOS.com

When trouble arises

8

8-1. Essential information

Emergency flashers	556
If your vehicle has to be stopped in an emergency	557

8-2. Steps to take in an emergency

If your vehicle needs to be towed	559
If you think something is wrong	564
Fuel pump shut off system (gasoline engine only)	565
Fire extinguisher	566
If a warning light turns on or a warning buzzer sounds	567
If a warning message is displayed	577
If you have a flat tire	584
If the engine will not start	601
If the electronic key does not operate properly (vehicles with smart entry & start system)	603
If the vehicle battery is discharged	607
If your vehicle overheats	613
If you run out of fuel and the engine stalls (diesel engine only)	616
If the vehicle becomes stuck	617

اورجنا خودرو فارما

تلفن شماره روزی: ۰۲۱-۸۸۸۶۲۰۸۵

FarmaSOS.com

Emergency flashers

The emergency flashers are used to warn other drivers when the vehicle has to be stopped in the road due to a breakdown, etc.

Press the switch.

All the turn signal lights will flash.

To turn them off, press the switch once again.

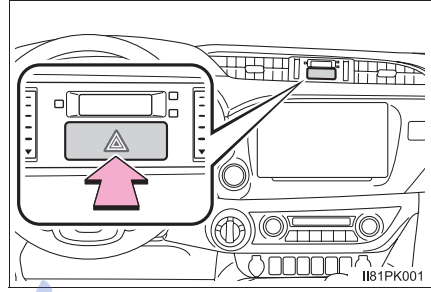

■ Emergency flashers

If the emergency flashers are used for a long time while the engine is not operating, the battery may discharge.

تلفن شبانه روزی: ۰۲۱-۸۸۸۶۲۰۸۵

FarmaSOS.com

If your vehicle has to be stopped in an emergency

Only in an emergency, such as if it becomes impossible to stop the vehicle in the normal way, stop the vehicle using the following procedure:

- 1 Steadily step on the brake pedal with both feet and firmly depress it.
Do not pump the brake pedal repeatedly as this will increase the effort required to slow the vehicle.
- 2 Shift the shift lever to N.
 - ▶ If the shift lever is shifted to N
- 3 After slowing down, stop the vehicle in a safe place by the road.
- 4 Stop the engine.
 - ▶ If the shift lever cannot be shifted to N
- 3 Keep depressing the brake pedal with both feet to reduce vehicle speed as much as possible.

- 4 Vehicles without smart entry & start system:

Stop the engine by turning the engine switch to the "ACC" position.

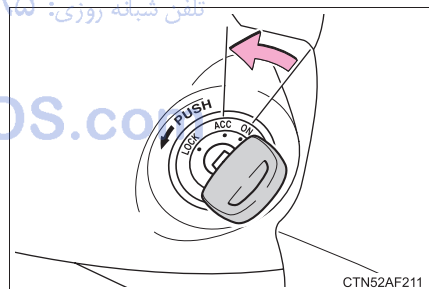

Vehicles with smart entry & start system:

To stop the engine, press and hold the engine switch for 2 consecutive seconds or more, or press it briefly 3 times or more in succession.

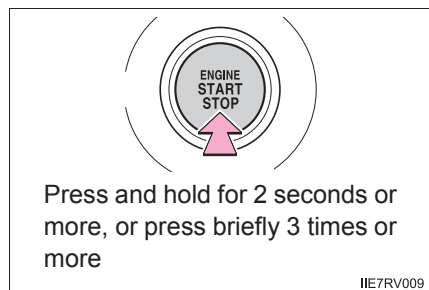

- 5 Stop the vehicle in a safe place by the road.

**WARNING****■ If the engine has to be turned off while driving**

- Power assist for the brakes and steering wheel will be lost, making the brake pedal harder to depress and the steering wheel heavier to turn. Decelerate as much as possible before turning off the engine.
- Vehicles without smart entry & start system: Never attempt to remove the key, as doing so will lock the steering wheel.

امداد خودرو فارما

تلفن شبانه روزی: ۰۲۱-۸۸۸۶۲۰۸۵

FarmaSOS.com

If your vehicle needs to be towed

If towing is necessary, we recommend having your vehicle towed by any authorized Toyota dealer or repairer, or another duly qualified and equipped professional or commercial towing service, using a wheel-lift type truck or flatbed truck.

Use a safety chain system for all towing, and abide by all state/provincial and local laws.

Situations when it is necessary to contact dealers before towing

The following may indicate a problem with your transmission. Contact any authorized Toyota dealer or repairer, or another duly qualified and equipped professional or commercial towing service before towing.

- The engine is running but the vehicle does not move.
- The vehicle makes an abnormal sound.

Towing with a sling-type truck

Do not tow with a sling-type truck to prevent body damage.

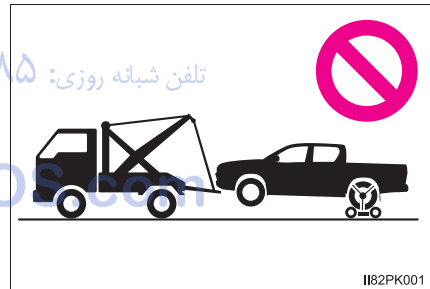

Towing with a wheel-lift type truck

► From the front

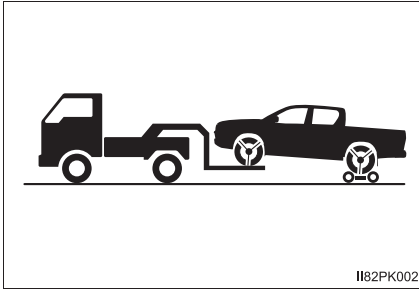

Use a towing dolly under the rear wheels.

► From the rear

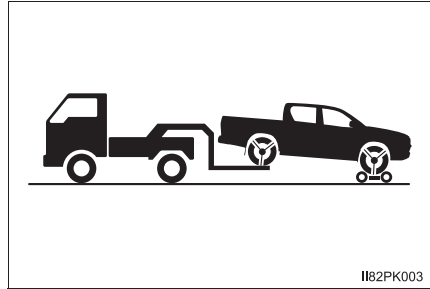

Use a towing dolly under the front wheels.

Using a flatbed truck

If your vehicle is transported by a flatbed truck, it should be tied down at the locations shown in the illustration.

When attaching the hooks to the rear of the vehicle, make sure to attach them to the inside of the vehicle.

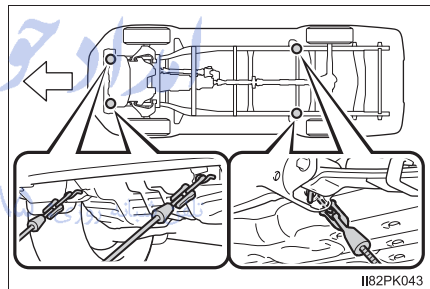

If you use chains or cables to tie down your vehicle, the angles shaded in black must be 45°.

Do not overly tighten the tie downs or the vehicle may be damaged.

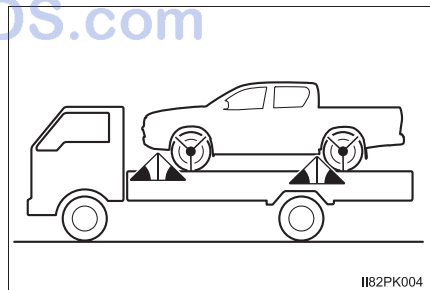

Emergency towing

If a tow truck is not available in an emergency, your vehicle may be temporarily towed using cables or chains secured to the emergency towing hooks. This should only be attempted on hard surfaced roads for at most 80 km (50 miles) at under 30 km/h (18 mph).

A driver must be in the vehicle to steer and operate the brakes. The vehicle's wheels, drive train, axles, steering and brakes must be in good condition.

Emergency towing procedure

- 1 Securely attach cables or chains to the towing hooks.

Take care not to damage the vehicle body.

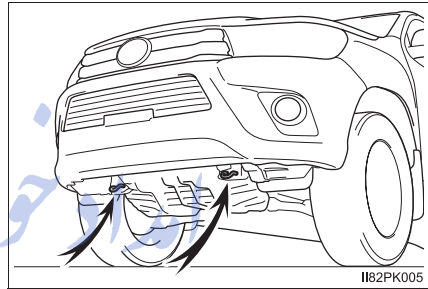

- 2 Enter the vehicle being towed and start the engine.

If the engine does not start, turn the engine switch to the "ON" position (vehicles without smart entry & start system) or IGNITION ON mode (vehicles with smart entry & start system).

Vehicles with Stop & Start system;

Before towing the vehicle, turn the engine switch to the "LOCK" position (vehicles without smart entry & start system) or off (vehicles with smart entry & start system) once, and then start the engine.

- 3 4WD models: Turn the front-wheel drive control switch to H2.
(→P. 329)
- 4 Shift the shift lever to N and release the parking brake.
When the shift lever cannot be shifted (automatic transmission):
→P. 252

■ While towing

If the engine is not running, the power assist for the brakes and steering will not function, making steering and braking more difficult.

⚠ WARNING

Observe the following precautions.
Failure to do so may result in death or serious injury.

■ When towing the vehicle

Pre Runner (2WD models): Be sure to transport the vehicle with all four wheels raised off the ground. If the vehicle is towed with the tires contacting the ground, the drivetrain and related parts may be damaged or an accident may occur due to a change in direction of the vehicle.

4WD models: Be sure to transport the vehicle with all four wheels raised off the ground. If the vehicle is towed with the tires contacting the ground, the drivetrain and related parts may be damaged, and the vehicle may fly off the truck.

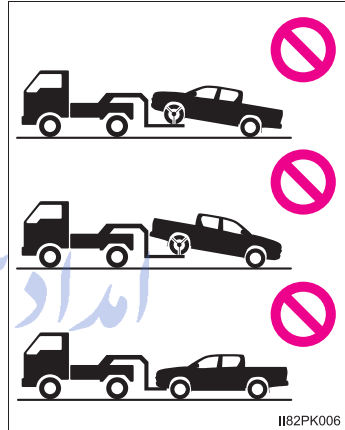

■ While towing

- When towing using cables or chains, avoid sudden starts, etc. which place excessive stress on the towing hooks, cables or chains. The towing hooks, cables or chains may become damaged, broken debris may hit people, and cause serious damage.
- Do not turn the engine switch to the "LOCK" position (vehicles without smart entry & start system) or off (vehicles with smart entry & start system).
There is a possibility that the steering wheel is locked and cannot be operated.

 NOTICE**■ To prevent damage to the vehicle when towing using a wheel-lift type truck**

- Do not tow the vehicle from the rear when the engine switch is in the "LOCK" position or the key is removed (vehicles without smart entry & start system) or the engine switch is turned to off (vehicles with smart entry & start system). The steering lock mechanism is not strong enough to hold the front wheels straight.
- When raising the vehicle, ensure adequate ground clearance for towing at the opposite end of the raised vehicle. Without adequate clearance, the vehicle could be damaged while being towed.

■ To prevent damage to the vehicle when towing with a sling-type truck

Do not tow with a sling-type truck, either from the front or rear.

■ To prevent damage to the vehicle during emergency towing

Do not secure cables or chains to the suspension components.

■ When towing a vehicle equipped with the Stop & Start system (if equipped)

When it is necessary to tow the vehicle with all four wheels contacting the ground, perform the following procedure before towing the vehicle to protect the system.

Turn the engine switch to the "LOCK" position (vehicles without smart entry & start system) or off (vehicles with smart entry & start system) once, and then start the engine. If the engine does not start, turn the engine switch to the "ON" position (vehicles without smart entry & start system) or IGNITION ON mode (vehicles with smart entry & start system).

FarmaSOS.com

If you think something is wrong

If you notice any of the following symptoms, your vehicle probably needs adjustment or repair. Contact any authorized Toyota dealer or repairer, or another duly qualified and equipped professional as soon as possible.

Visible symptoms

- Fluid leaks under the vehicle.
(Water dripping from the air conditioning after use is normal.)
- Flat-looking tires or uneven tire wear
- Engine coolant temperature gauge needle continually points higher than normal.

Audible symptoms

- Changes in exhaust sound
- Excessive tire squeal when cornering
- Strange noises related to the suspension system
- Pinging or other noises related to the engine

Operational symptoms

- Engine missing, stumbling or running roughly
- Appreciable loss of power
- Vehicle pulls heavily to one side when braking
- Vehicle pulls heavily to one side when driving on a level road
- Loss of brake effectiveness, spongy feeling, pedal almost touches the floor

Fuel pump shut off system (gasoline engine only)

To minimize the risk of fuel leakage when the engine stalls or when an airbag inflates upon collision, the fuel pump shut off system stops the supply of fuel to the engine.

Follow the procedure below to restart the engine after the system is activated.

- 1 Turn the engine switch to the “ACC” or “LOCK” position (vehicles without smart entry & start system) or ACCESSORY mode or off (vehicles with smart entry & start system).
- 2 Restart the engine.



NOTICE

■ **Before starting the engine**

Inspect the ground under the vehicle.

If you find that fuel has leaked onto the ground, the fuel system has been damaged and is in need of repair. Do not restart the engine.

تلفن شبانه روزی: ۰۲۱-۸۸۸۶۲۰۸۵

FarmaSOS.com

Fire extinguisher*

A fire extinguisher is located under the front passenger's seat. It is for use in emergencies, such as in the event of a fire.

For information about using, refer to the label on the fire extinguisher.

Taking out the fire extinguisher

Unhook the tightening strap and take out the fire extinguisher.

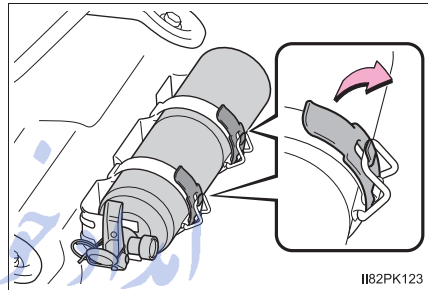

The shape of the fire extinguisher and tightening strap, and the taking out procedure may differ from those shown in the illustration.

■ After using the fire extinguisher

Store it securely in place. Replace it with a new one as soon as possible.

⚠ WARNING

■ When the fire extinguisher is not in use

Keep the fire extinguisher securely in place. Otherwise, it may be thrown about in the event of sudden braking or a collision.

⚠ NOTICE

■ Fire extinguisher



- Do not reuse the fire extinguisher.
Replace it with a new one as soon as possible after using it.
- Use a genuine Toyota fire extinguisher when replacing.
If a non-genuine Toyota fire extinguisher is used, it may not be possible to secure the fire extinguisher properly and it may come loose.





*: If equipped





If a warning light turns on or a warning buzzer sounds



Calmly perform the following actions if any of the warning lights comes on or flashes. If a light comes on or flashes, but then goes off, this does not necessarily indicate a malfunction in the system. However, if this continues to occur, have the vehicle inspected by any authorized Toyota dealer or repairer, or another duly qualified and equipped professional.







Warning light and warning buzzer list





Warning light	Warning light/Details/Actions
	<p>Brake system warning light (warning buzzer) Indicates:</p> <ul style="list-style-type: none"> • Low brake fluid • Malfunction in the brake system • Low negative pressure in the vacuum tank (diesel engine) <p>→ Immediately stop the vehicle in a safe place and contact any authorized Toyota dealer or repairer, or another duly qualified and equipped professional. Continuing to drive the vehicle may be dangerous.</p>
	<p>Charging system warning light (if equipped) Indicates a malfunction in the vehicle's charging system</p> <p>→ Immediately stop the vehicle in a safe place and contact any authorized Toyota dealer or repairer, or another duly qualified and equipped professional.</p>
	<p>Low engine oil pressure warning light (warning buzzer) (if equipped) *1 Indicates that the engine oil pressure is too low (This warning light may come on if the vehicle is stopped on a slope. Move to a level surface and check to see if the light goes off.)</p> <p>→ Immediately stop the vehicle in a safe place and contact any authorized Toyota dealer or repairer, or another duly qualified and equipped professional.</p>

Warning light	Warning light/Details/Actions
	<p>Malfunction indicator lamp (warning buzzer) Indicates the followings if the warning light comes on or flashes:</p> <ul style="list-style-type: none"> • Malfunction in the emission control system. (if equipped) • Malfunction in the electronic engine control system. • Malfunction in the electronic automatic transmission control system. (if equipped) • The boost pressure in the turbocharger is abnormally high.*2 (diesel engine) • Malfunction in DPF system. (if equipped) <p>→ Have the vehicle inspected by any authorized Toyota dealer or repairer, or another duly qualified and equipped professional immediately.</p>
	<p>SRS warning light Indicates a malfunction in:</p> <ul style="list-style-type: none"> • The SRS airbag system; • The seat belt pretensioner system (if equipped) or • The front passenger occupant classification system (if equipped); <p>→ Have the vehicle inspected by any authorized Toyota dealer or repairer, or another duly qualified and equipped professional immediately.</p>
	<p>ABS warning light • ۸۵ تلفن شبانه روزی: www.Farmat3S.com Indicates a malfunction in:</p> <ul style="list-style-type: none"> • The ABS; or • The brake assist system (vehicles with VSC system) <p>→ Have the vehicle inspected by any authorized Toyota dealer or repairer, or another duly qualified and equipped professional immediately.</p>
	<p>Slip indicator light (if equipped) Indicates a malfunction in:</p> <ul style="list-style-type: none"> • The VSC system (if equipped); • Trailer sway control system (if equipped); • The TRC/A-TRC system (if equipped); • The hill-start assist control system (if equipped); or • The downhill assist control system (if equipped) <p>→ Have the vehicle inspected by any authorized Toyota dealer or repairer, or another duly qualified and equipped professional immediately. The light will flash when any of the above systems other than the hill-start assist control system are operating.</p>

Warning light	Warning light/Details/Actions
	<p>Four-wheel drive indicator light (warning buzzer)*³ (if equipped)</p> <p>Indicates that the differential oil temperature is too high when the light flashes rapidly and a buzzer sounds.</p> <p>→ Turn the front-wheel drive control switch to H2, and wait until the warning light goes off.</p> <p>Indicates a malfunction in the four-wheel drive system when the light flashes rapidly and a buzzer does not sound.</p> <p>→ Have the vehicle inspected by any authorized Toyota dealer or repairer, or another duly qualified and equipped professional immediately.</p>
	<p>Low speed four-wheel drive indicator light (if equipped)</p> <p>Indicates a malfunction in the four-wheel drive system when the light flashes rapidly.</p> <p>→ Have the vehicle inspected by any authorized Toyota dealer or repairer, or another duly qualified and equipped professional immediately.</p>
	<p>Rear differential lock indicator light (if equipped)</p> <p>Indicates a malfunction in the rear differential lock system when the light flashes rapidly.</p> <p>→ Have the vehicle inspected by any authorized Toyota dealer or repairer, or another duly qualified and equipped professional immediately.</p>
	<p>Timing belt replacement warning light (if equipped)</p> <p>Indicates that the timing belt should be replaced</p> <p>→ Have the vehicle inspected by any authorized Toyota dealer or repairer, or another duly qualified and equipped professional.</p>
	<p>Fuel system warning light (warning buzzer)*⁴ (if equipped)</p> <p>The amount of accumulated water in the fuel filter has reached the specified level if the light flashes.</p> <p>→ P. 512</p> <p>The fuel filter need to be replaced if the light comes on.</p> <p>→ Have the vehicle inspected by any authorized Toyota dealer or repairer, or another duly qualified and equipped professional immediately.</p>

Warning light	Warning light/Details/Actions
	<p>Brake Override System warning light (if equipped) Indicates that the accelerator and brake pedal are being depressed simultaneously if the warning light comes on (→P. 211)</p> <p>→ Release the accelerator or brake pedal. Indicates a malfunction in the Brake Override System if the warning light flashes</p> <p>→ Have the vehicle inspected by any authorized Toyota dealer or repairer, or another duly qualified and equipped professional immediately.</p>
	<p>PCS warning light (if equipped) When the warning light flashes (and a buzzer sounds): Indicates a malfunction in PCS (Pre-Crash Safety system)</p> <p>→ Have the vehicle inspected by any authorized Toyota dealer or repairer, or another duly qualified and equipped professional immediately.</p> <p>When the warning light flashes (and a buzzer does not sounds): Indicates that PCS (Pre-Crash Safety system) is temporarily unavailable, possibly due to either of the following</p> <ul style="list-style-type: none"> • An area around the radar sensor or camera sensor being dirty or covered with condensation, ice, stickers, etc. <p>→ Clear the dirt, condensation, ice, stickers, etc. (→P. 282, 283)</p> <ul style="list-style-type: none"> • Radar sensor or camera sensor operational conditions (such as temperature etc.) being not met <p>→ Driving is possible in this case. PCS (Pre-Crash Safety system) will be enabled if the operational conditions (such as temperature etc.) are met again.</p> <p>When the warning light is illuminated: Either VSC (Vehicle Stability Control) or PCS (Pre-Crash Safety system) is disabled or both are disabled.</p> <p>→ To enable PCS, enable both VSC and PCS. (→P. 291, 356)</p>

Warning light	Warning light/Details/Actions
	<p>LDA indicator (warning buzzer) (if equipped on vehicles with multi-information display type B) Indicates that the LDA (Lane Departure Alert) system is not available temporarily or has detected a malfunction when the warning light is illuminated in yellow and a warning message is displayed on the multi-information display. → P. 307</p>
	<p>Open door warning light (warning buzzer)*⁵ (if equipped) Indicates that a door is not fully closed → Check that all the doors are closed.</p>
	<p>Driver's and front passenger's seat belt reminder light (warning buzzer)*⁶ Warns the driver and front passenger to fasten his/her seat belt → Fasten the seat belt.</p>
 <p>(On the center panel)</p>	<p>Rear passengers' seat belt reminder lights (warning buzzer)*⁸ (if equipped) Warn the rear passengers to fasten their seat belts → Fasten the seat belt.</p>
	<p>Low fuel level warning light Indicates remaining fuel is approximately 12.0 L (3.2 gal., 2.6 Imp.gal.) or less → Refuel the vehicle.</p>
	<p>Low engine oil level warning light (if equipped) Indicates that engine oil level is low (This warning light may come on if the vehicle is stopped on a slope. Move the vehicle to a level surface and check to see if the light goes off.) → Check the level of engine oil and add more oil if necessary.</p>
	<p>Master warning light (warning buzzer) (if equipped) A buzzer sounds and the warning light comes on and flashes to indicate that the master warning system has detected a malfunction. → P. 577</p>

Warning light	Warning light/Details/Actions
 <p>(Flashes)</p>	<p>Stop & Start cancel indicator (if equipped) Indicates a malfunction in the Stop & Start system (The Stop & Start cancel indicator will come on when the system is canceled: →P. 344) → Have the vehicle inspected by any authorized Toyota dealer or repairer, or another duly qualified and equipped professional immediately.</p>
	<p>Parking brake indicator light (warning buzzer)*⁹ Warns the driver to release parking brake. → Release the parking brake.</p>
	<p>Speed warning light (warning buzzer)*¹⁰ (if equipped) Indicates that your vehicle speed reaches or exceeds 120 km/h (75 mph). → Reduce vehicle speed.</p>
	<p>Low AdBlue™ level warning light (if equipped) Indicates that AdBlue™ level is low → Have AdBlue™ refilled at any authorized Toyota dealer or repairer, or another duly qualified and equipped professional.</p>
 <p>(if equipped)</p>	<p>Tire pressure warning light When the light comes on: Low tire inflation pressure such as: تلفن • Natural causes (→P. 574) • Flat tire (→P. 584) → Adjust the tire inflation pressure to the specified level. The light will turn off after a few minutes. In case the light does not turn off even if the tire inflation pressure is adjusted, have the system checked by any authorized Toyota dealer or repairer, or another duly qualified and equipped professional. When the light comes on after blinking for 1 minute: Malfunction in the tire pressure warning system (→P. 575) → Have the system checked by any authorized Toyota dealer or repairer, or another duly qualified and equipped professional.</p>

- *1: The buzzer sounds if the vehicle reaches a speed of 5 km/h (3 mph).
- *2: Slow down until the lamp goes off.
- *3: The buzzer sounds when the differential oil temperature is too high and turning the front-wheel drive control switch to H2 is required.
- *4: The buzzer will sound at the same time the warning light flashes.
- *5: The open door warning buzzer sounds if the vehicle reaches or exceeds a speed of 5 km/h (3 mph).
- *6: Models for model code destination V*7: The driver's and front passenger's seat belt buzzer sounds to alert the driver and front passenger that his or her seat belt is not fastened. Once the engine switch is turned to the "ON" position (vehicles without smart entry & start system) or IGNITION ON mode (vehicles with smart entry & start system), the buzzer sounds for 6 seconds. If the vehicle reaches a speed of 20 km/h (12 mph), the buzzer sounds once. If the seat belt is still unfastened after 30 seconds, the buzzer will sound intermittently for 10 seconds. Then, if the seat belt is still unfastened, the buzzer will sound in a different tone for 20 more seconds. Except models for model code destination V*7: The driver's and front passenger's seat belt buzzer sounds to alert the driver and front passenger that his or her seat belt is not fastened. The buzzer sounds intermittently for 30 seconds after the vehicle reaches a speed of 20 km/h (12 mph). Then, if the seat belt is still unfastened, the buzzer will sound in a different tone for 90 more seconds.
- *7: See "Checking your vehicle's model" if you are not sure of which model your vehicle is. (→P. 11)
- *8: The rear passengers' seat belt buzzer sounds to alert the rear passenger that his or her seat belt is not fastened. The buzzer sounds intermittently for 30 seconds after the vehicle reaches a speed of 20 km/h (12 mph). Then, if the seat belt is still unfastened, the buzzer will sound in a different tone for 90 more seconds.
- *9: The parking brake engaged warning buzzer sounds if the vehicle reaches a speed of approximately 5 km/h (3 mph) or more.
- *10: The speed warning buzzer sounds if the vehicle reaches or exceeds a speed of 120 km/h (75 mph) and will stop sounding after 6 seconds or if you decelerate below 120 km/h (75 mph).

Other warning light

Carrying out the corresponding action turns the warning light off.

Warning light	Warning light/Details/Actions
	<p>Go to service warning light (warning buzzer) (if equipped)</p> <p>Indicates a malfunction in the electronic engine control system or electronic throttle control system, or the Brake Override System.</p> <p>→ Have the vehicle inspected by any authorized Toyota dealer or repairer, or another duly qualified and equipped professional.</p>

■ If the malfunction indicator lamp comes on while driving

For some models, malfunction indicator lamp will come on if the fuel tank becomes completely empty. If the fuel tank is empty, refuel the vehicle immediately. The malfunction indicator lamp will go off after several trips.

If the malfunction indicator lamp does not go off, contact any authorized Toyota dealer or repairer, or another duly qualified and equipped professional as soon as possible.

■ When the tire pressure warning light comes on (if equipped)

Carry out the following procedure after the tire temperature has lowered sufficiently.

- Check the tire inflation pressure and adjust to the appropriate level.
- If the warning light does not go out even after several minutes, check that the tire inflation pressure is at the specified level and carry out initialization.

The warning light may come on again if the above operations are conducted without first allowing the tire temperature to lower sufficiently.

■ The tire pressure warning light may come on due to natural causes (if equipped)

The tire pressure warning light may come on due to natural causes such as natural air leaks and tire inflation pressure changes caused by temperature. In this case, adjusting the tire inflation pressure will turn off the warning light (after a few minutes).

■ When a tire is replaced with the spare tire (vehicles with the tire pressure warning system)

The tire pressure warning light will turn on if the tire inflation pressure of the spare tire is low. If a tire goes flat, the tire pressure warning light will not turn off even though the flat tire has been replaced with the spare tire.

■ **Conditions that the tire pressure warning system may not function properly (if equipped)**

→P. 522

■ **If the tire pressure warning light frequently comes on after blinking for 1 minute (if equipped)**

If the tire pressure warning light frequently comes on after blinking for 1 minute when the engine switch is turned on, have it checked by any authorized Toyota dealer or repairer, or another duly qualified and equipped professional.



WARNING

■ **If a warning light comes on or a warning buzzer sounds when a warning message is shown on the multi-information display (vehicles with multi-information display)**

Check and follow the message shown on the multi-information display. Failure to do so may result in death or serious injury.

■ **If both the ABS and the brake system warning lights remain on**

Stop your vehicle in a safe place immediately and contact any authorized Toyota dealer or repairer, or another duly qualified and equipped professional. The vehicle will become extremely unstable during braking, and the ABS system may fail, which could cause an accident resulting in death or serious injury.

■ **If the tire pressure warning light comes on (vehicles with the tire pressure warning system)**

Be sure to observe the following precautions. Failure to do so could cause a loss of vehicle control and result in death or serious injury.

- Stop your vehicle in a safe place as soon as possible. Adjust the tire inflation pressure immediately.
- If the tire pressure warning light comes on even after tire inflation pressure adjustment, it is probable that you have a flat tire. Check the tires. If a tire is flat, change it with the spare tire and have the flat tire repaired by the nearest authorized Toyota dealer or repairer, or another duly qualified and equipped professional.
- Avoid abrupt maneuvering and braking. If the vehicle tires deteriorate, you could lose control of the steering wheel or the brakes.

■ **If a blowout or sudden air leakage should occur (vehicles with the tire pressure warning system)**

The tire pressure warning system may not activate immediately.



NOTICE

- **If the malfunction indicator lamp comes on when the boost pressure in the turbocharger is abnormally high (diesel engine)**

Never drive at high speed or race the engine even after the lamp goes off.

- **If the fuel system warning light flashes (diesel engine)**

Never drive the vehicle with the warning light flashing. Continued driving with water accumulated in the fuel filter will damage the fuel injection pump.

- **To ensure the tire pressure warning system operates properly (vehicles with the tire pressure warning system)**

Do not install tires with different specifications or makers, as the tire pressure warning system may not operate properly.

امداد خودرو فارما

تلفن شبانه روزی: ۰۲۱-۸۸۸۶۲۰۸۵

FarmaSOS.com

If a warning message is displayed*

The multi-information display shows warnings of system malfunctions, incorrectly performed operations, and messages that indicate a need for maintenance. When a message is shown, perform the correction procedure appropriate to the message.

▶ Vehicles with multi-information display type A

▶ Vehicles with multi-information display type B

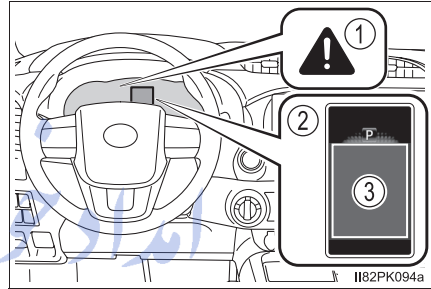
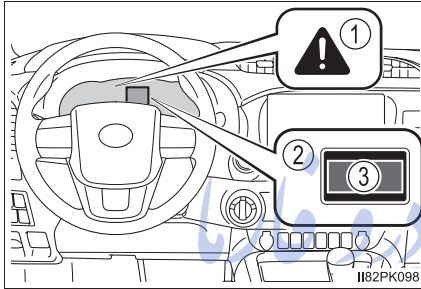

① Master warning light

The master warning light also comes on or flashes in order to indicate that a message is currently being displayed on the multi-information display.

② Multi-information display

③ Handling method

Follow the instructions of the message on the multi-information display.

If any of the warning messages comes on again after the following actions have been performed, contact any authorized Toyota dealer or repairer, or another duly qualified and equipped professional.

*: If equipped

Messages and warnings

The warning lights and warning buzzers operate as follows depending on the content of the message. If a message indicates the need for inspection by a dealer, have the vehicle inspected by any authorized Toyota dealer or repairer, or another duly qualified and equipped professional immediately.

	System warning light	Warning buzzer*	Warning
Comes on	Comes on	Sounds	Indicates an important situation, such as when a system related to driving is malfunctioning or that danger may result if the correction procedure is not performed
Comes on	—	Sounds	
—	Comes on or flashes	Sounds	Indicates an important situation, such as when the systems shown on the multi-information display may be malfunctioning
Flashes	—	Sounds	Indicates a situation, such as when damage to the vehicle or danger may result. تلفن شبانه روزی: ۰۲۱-۸۸۸۶۲۰۲۱
Comes on	—	Does not sound	Indicates a condition, such as malfunction of electrical components, their condition, or indicates the need for maintenance
Flashes	—	Does not sound	Indicates a situation, such as when an operation has been performed incorrectly, or indicates how to perform an operation correctly

*: A buzzer sounds the first time a message is shown on the multi-information display.

■ If  is shown on the multi-information display

The engine oil pressure is too low. (This warning message may be displayed if the vehicle is stopped on a slope. Move to a level surface and check to see if the message goes off.)

Immediately stop the vehicle in a safe place and contact any authorized Toyota dealer or repairer, or another duly qualified and equipped professional. Continuing to drive the vehicle may be dangerous.

■ If **“ACCELERATOR AND BRAKE PEDALS DEPRESSED SIMULTANEOUSLY”** / **“Accelerator and brake pedals depressed simultaneously”** is shown on the multi-information display

The accelerator and brake pedal are being depressed simultaneously.

(→P. 211)

Release the accelerator or brake pedal.

■ If **“WINDSHIELD WASHER FLUID LOW”** / **“Windshield washer fluid low”** is shown on the multi-information display

The washer fluid level is low.

Add washer fluid. (→P. 511)

■ If **“OIL MAINTENANCE REQUIRED SOON”** / **“Oil maintenance required soon”** is shown on the multi-information display

The engine oil is scheduled to be changed.

Check the engine oil, and change if necessary. After changing the engine oil, the oil change system should be reset. (→P. 504)

For Russia, Ukraine, Byelarus, Moldova, Bosnia Herzegovina, Montenegro, Serbia and Macedonia: You have forgotten to reset the oil change system. Change the engine oil in accordance with the maintenance schedule.

■ If **“OIL MAINTENANCE REQUIRED”** / **“Oil maintenance required”** is shown on the multi-information display

The engine oil is scheduled to be changed.

Check and change the engine oil, and oil filter by any authorized Toyota dealer or repairer, or another duly qualified and equipped professional. After changing the engine oil, the oil change system should be reset. (→P. 504)

For Russia, Ukraine, Byelarus, Moldova, Bosnia Herzegovina, Montenegro, Serbia and Macedonia: You have forgotten to reset the oil change system. Change the engine oil in accordance with the maintenance schedule.

■ If **“T-BELT MAINTENANCE REQUIRED”/“T-BELT maintenance required”** is shown on the multi-information display

The timing belt is scheduled to be changed.

Have the timing belt checked and/or changed by any authorized Toyota dealer or repairer, or another duly qualified and equipped professional.

■ If **“DIFFERENTIAL OIL TEMP HIGH COOLING TIME REQUIRED”/“Differential oil temp high Cooling time required”** is shown on the multi-information display

The differential oil temperature is too high.

Wait until the warning message goes off.

■ If **“OVER 120km/h”/“Over 120km/h”** is shown on the multi-information display

The vehicle speed has reached or exceeded 120 km/h (75 mph). At this time, a buzzer also sounds. The buzzer will stop sounding after 6 seconds or if you decelerate below 120 km/h (75 mph).

Reduce your vehicle speed.

■ If **“ENGINE OIL LEVEL LOW ADD OR REPLACE”/“Engine oil level low Add or replace”** is shown on the multi-information display

The engine oil level is low. (This warning message may be displayed if the vehicle is stopped on a slope. Move to a level surface and check to see if the message goes off.)

Check the level of the engine oil and add or replace oil if necessary.

(→P. 492)

■ If **“POWER TURNED OFF TO SAVE BATTERY”/“Power turned off to save battery”** is shown on the multi-information display

Power was turned off due to the automatic power off function.

Next time when starting the engine, increase the engine speed slightly and maintain that level for approximately 5 minutes to recharge the battery.

- If “DPF FULL SEE OWNER’S MANUAL”/“DPF full See owner’s manual” or “DPF FULL MANUAL REGENERATION REQUIRED SEE OWNER’S MANUAL”/“DPF full Manual regeneration required See owner’s manual” is shown on the multi-information display

The deposit collected in the filter needs to be regenerated.

Vehicles without DPF system switch:

To regenerate the filter, the following driving methods are recommended*.

- By driving continuously (for example, at around 65 km/h [40 mph] for 20 to 30 minutes).
- By avoiding short trips, or by driving continuously (leaving the engine running for long periods of time).

When the outside temperature is approximately -15°C (5°F) or lower, check the engine is warmed up before driving the vehicle to regenerate the filter. If the engine is cold, warm up the engine by driving the vehicle downshifting to increase the engine speed. Depending on the situation, it may be necessary to depress the accelerator pedal until the engine speed is increased to 3000 rpm.

The warning message will disappear when regeneration is completed. However, if this driving cannot be carried out, or if the message does not disappear even after driving, have the vehicle inspected by any authorized Toyota dealer or repairer, or another duly qualified and equipped professional immediately.

For details of the DPF system, refer to P. 364.

*: When driving, pay sufficient attention to weather, road conditions, terrain and traffic conditions, and drive according to traffic laws.

Vehicles with DPF system switch:

→P. 365

FarmaSOS.com

■ If **“PRE-CRASH SAFETY UNAVAILABLE”/“Pre-Crash Safety Unavailable”** is shown on the multi-information display

PCS (Pre-Crash Safety system) is temporarily unavailable. Wait until the system returns. If the message does not disappear, that system may be malfunctioning. Have the vehicle inspected by any authorized Toyota dealer or repairer, or another duly qualified and equipped professional immediately.

■ If **“FORWARD CAMERA SYSTEM UNAVAILABLE”/“Forward Camera System Unavailable”** or **“FORWARD CAMERA SYSTEM UNAVAILABLE CLEAN WINDSHIELD”/“Forward Camera System Unavailable Clean Windshield”** is shown on the multi-information display

The following systems may be suspended until the problem shown in the message is resolved.

- PCS (Pre-Crash Safety system)
- LDA (Lane Departure Alert)
- RSA (Road Sign Assist)

■ If **“Check RSA system”** is shown on the multi-information display

The RSA system is malfunctioning.

Have the vehicle inspected by any authorized Toyota dealer or repairer, or another duly qualified and equipped professional immediately.

■ If **“SEE OWNER’S MANUAL”/“See owner’s manual”** is shown on the multi-information display

- If the following messages are shown, follow the instructions accordingly.
 - “TRANSMISSION FLUID TEMP HIGH”/“Transmission fluid temp high” (→P. 253)
 - “WATER ACCUMULATION IN FUEL FILTER”/“Water accumulation in fuel filter” (→P. 512)
 - “AdBlue LEVEL LOW FILL UP AdBlue IN 2400 km”/“AdBlue level low Fill up AdBlue in 2400 km” (→P. 513)
 - “AdBlue LEVEL LOW NO START IN 800 km! FILL UP AdBlue”/“AdBlue level low No start in 800 km! Fill up AdBlue” (→P. 513)
 - “AdBlue EMPTY UNABLE TO RESTART ENGINE FILL UP AdBlue”/“AdBlue empty Unable to restart engine Fill up AdBlue” (→P. 513)
- If **“SMART ENTRY & START SYSTEM MALFUNCTION”/“Smart entry & start system malfunction”** is shown, this may be a malfunction. Immediately have the vehicle inspected by any authorized Toyota dealer or repairer, or another duly qualified and equipped professional.
- If **“Low oil pressure Stop in a safe place”** is shown, there may be a malfunction. Immediately stop the vehicle in a safe place and contact any authorized Toyota dealer or repairer, or another duly qualified and equipped professional. Continuing to drive the vehicle may be dangerous.

■ **If “VISIT YOUR DEALER”/“Visit your dealer” is shown on the multi-information display**

The system or part shown on the multi-information display is malfunctioning. Have the vehicle inspected by any authorized Toyota dealer or repairer, or another duly qualified and equipped professional immediately.

■ **Warning buzzer**

In some cases, the buzzer may not be heard due to being in a noisy location or audio sound.

 **WARNING**

■ **If a warning light comes on or a warning buzzer sounds when a warning message is shown on the multi-information display**

Check and follow the message shown on the multi-information display. Failure to do so may result in death or serious injury.

 **NOTICE**

■ **While the engine oil level warning is displayed**

Continued engine operation with low engine oil will damage the engine.

■ **If “WATER ACCUMULATION IN FUEL FILTER SEE OWNER’S MANUAL”/“Water accumulation in fuel filter See owner’s manual” is shown on the multi-information display**

Never drive the vehicle if the warning message is displayed. Continued driving with water accumulated in the fuel filter will damage the fuel injection pump.

FarmaSOS.com

If you have a flat tire

- ▶ Vehicles without spare tire

Your vehicle is not equipped with a spare tire.

If you have a flat tire, we recommend having your vehicle towed by any authorized Toyota dealer or repairer, or another duly qualified and equipped professional or a commercial towing service.

- ▶ Vehicles with spare tire

Your vehicle is equipped with a spare tire. The flat tire can be replaced with the spare tire.

For details about tires: →P. 518

⚠ WARNING

■ If you have a flat tire

Do not continue driving with a flat tire.

Driving even a short distance with a flat tire can damage the tire and the wheel beyond repair, which could result in an accident.

Before jacking up the vehicle

- Stop the vehicle in a safe place on a hard, flat surface.
- Set the parking brake.
- Shift the shift lever to P (automatic transmission) or R (manual transmission).
- Stop the engine.
- Turn on the emergency flashers. (→P. 556)

Location of the spare tire

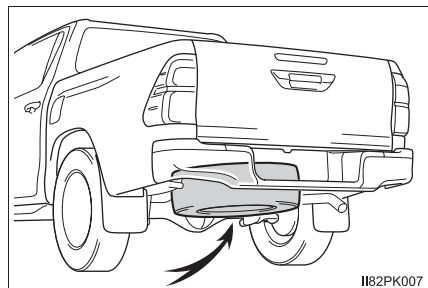

1182PK007

Location of the jack and tools

► Single-cab models

The jack and tools are stored behind the seat.

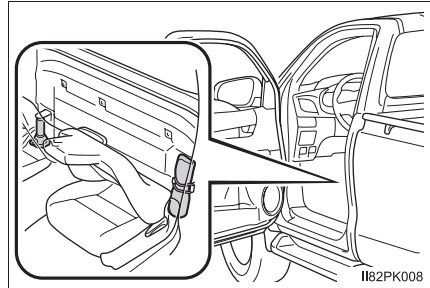

► Smart-cab models

The jack and tools are stored under the lid.

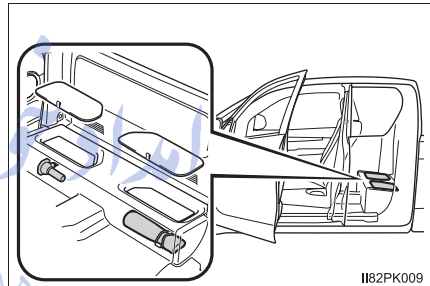

► Double-cab models

The jack and tools are stored under the bottom cushion.

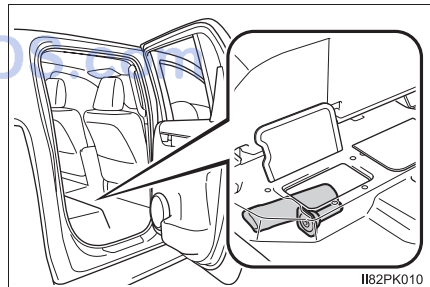

⚠ WARNING

■ Using the tire jack

Improper use of the tire jack may cause the vehicle to suddenly fall off the jack, leading to death or serious injury.

- Do not use the tire jack for any purpose other than replacing tires or installing and removing tire chains.
- Only use the tire jack that comes with this vehicle for replacing a flat tire. Do not use it on other vehicles, and do not use other tire jacks for replacing tires on this vehicle.
- Make sure the tire jack can be moved properly.
- Always check that the tire jack is securely set to the correct jack up point.
- Do not put any part of your body under the vehicle while it is supported by the jack.
- Do not start or run the engine while your vehicle is supported by the jack.
- Do not raise the vehicle while someone is inside.
- When raising the vehicle, do not put an object on or under the jack.
- Do not raise the vehicle to a height greater than that required to replace the tire.
- Do not continue jacking up once the yellow caution line has appeared.

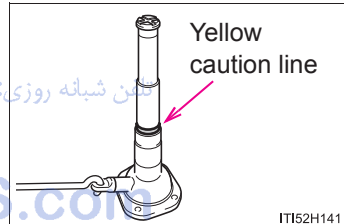

- Use a jack stand if it is necessary to get under the vehicle.

Take particular care when lowering the vehicle to ensure that no one working on or near the vehicle may be injured.

■ Using the jack handle

Insert the square head securely until you hear a click to prevent the extension parts from coming apart unexpectedly.

Taking out the jack and tool bag

► Single-cab models

- 1 Unhook the strap and take out the tool bag.

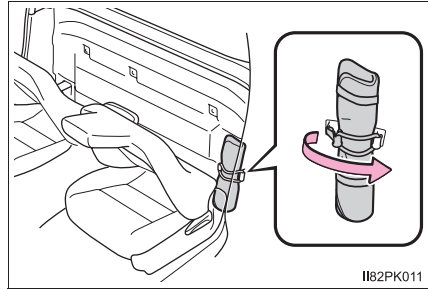

- 2 Take out the jack.

- ① For loosening
- ② For tightening

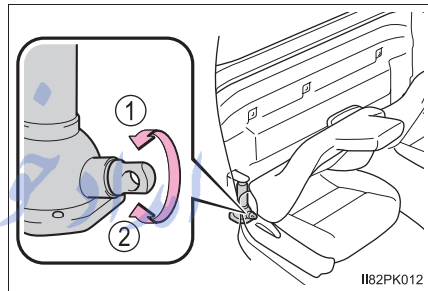

تلفن شبانه روزی: ۰۲۱-۸۸۸۶۲۰۸۵

FarmaSOS.com

► Smart-cab models

- 1 Vehicles with rear seat cushions: Remove the rear seat cushions. (→P. 188)
- 2 Pull the tag and open the lid.

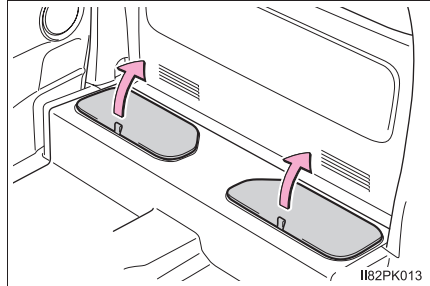

- 3 Unhook the strap and take out the tool bag.

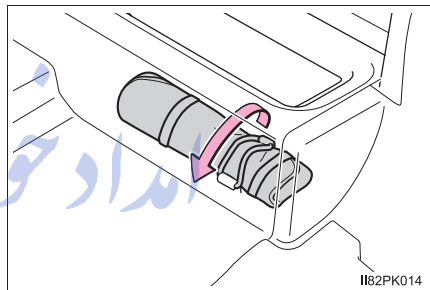

- 4 Take out the jack.

- ① For loosening
- ② For tightening

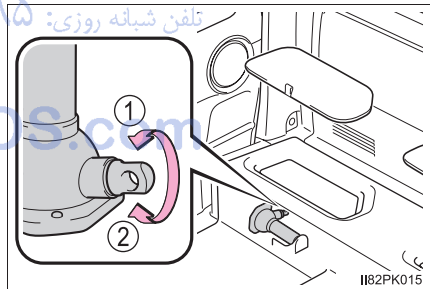

► Double-cab models

- 1 Tumbling the bottom cushion (→P. 188)
- 2 Open the lid.

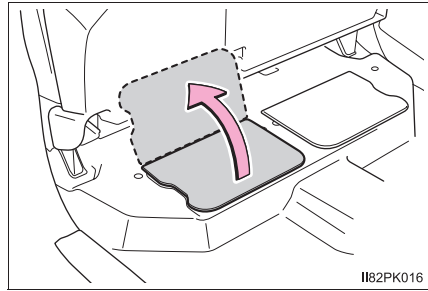

- 3 Take out the tool bag.

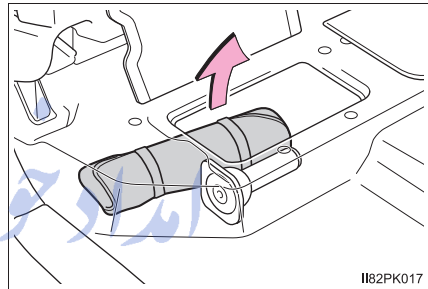

- 4 Take out the jack.

- ① For loosening
- ② For tightening

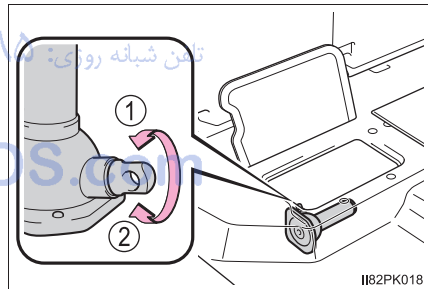

Taking out the spare tire

- 1 Assemble the jack handle end, jack handle extensions and wheel nut wrench.

To assemble the jack handle extension and wheel nut wrench, push in the projection on the jack handle extension.

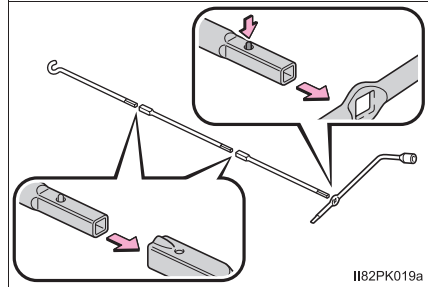

- 2 Insert the jack handle end into the lowering screw.

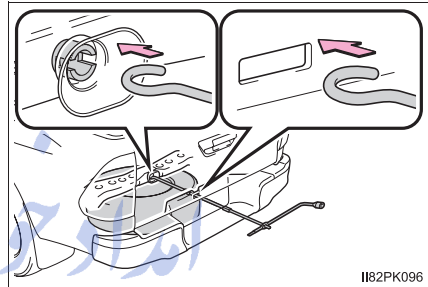

- 3 Lower the spare tire completely to the ground.

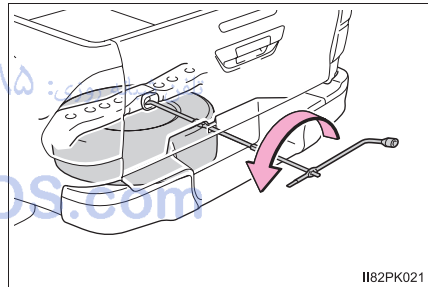

- 4 Remove the holding bracket and pull out the spare tire.

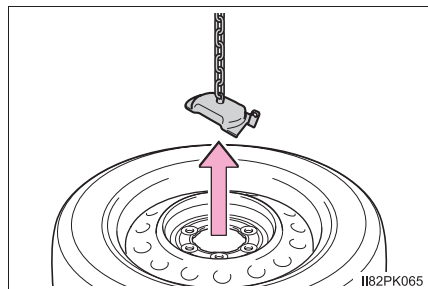

Replacing a flat tire

- 1 Chock the tires.

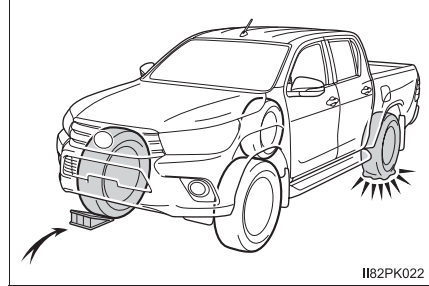

Flat tire		Wheel chock positions
Front	Left-hand side	Behind the rear right-hand side tire
	Right-hand side	Behind the rear left-hand side tire
Rear	Left-hand side	In front of the front right-hand side tire
	Right-hand side	In front of the front left-hand side tire

- 2 Remove the wheel ornament, using the beveled end of the wheel nut wrench as shown.

To protect the wheel ornament, place a rag between the wheel nut wrench and the wheel ornament.

- Type A

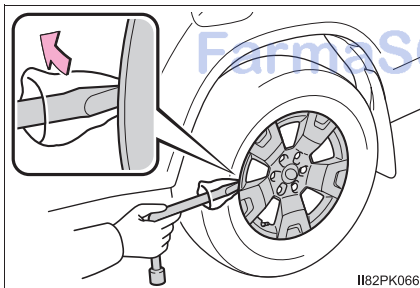

- Type B

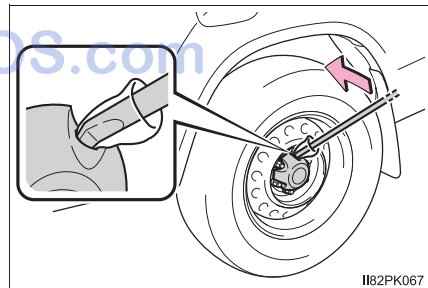

► Type C

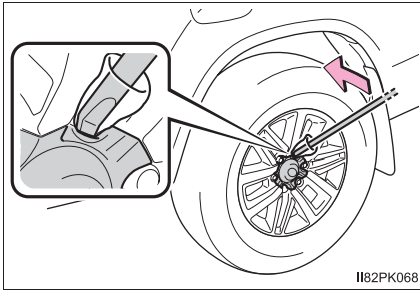

- 3 Slightly loosen the wheel nuts (one turn).

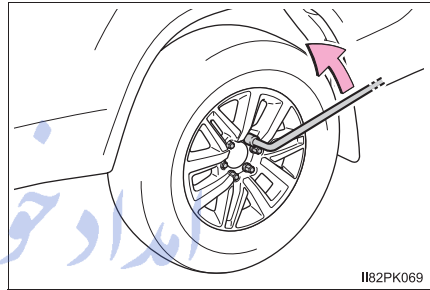

- 4 Assembling the jack handle. (→P. 590)
 5 Position the jack at the jack points as shown.

► Front

Under the cross member

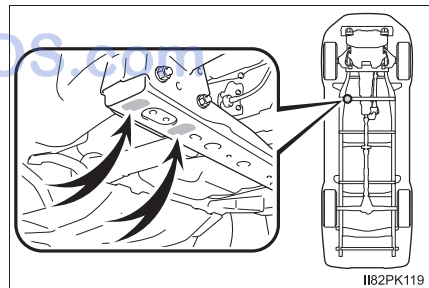

► Rear

Under the rear axle housing

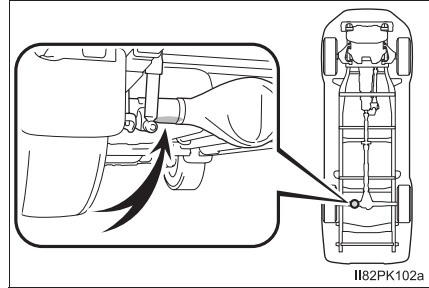

- 6 Raise the vehicle until the tire is slightly raised off the ground.

When positioning the jack under the rear axle housing, make sure the groove on the top of the jack fits with the rear axle housing.

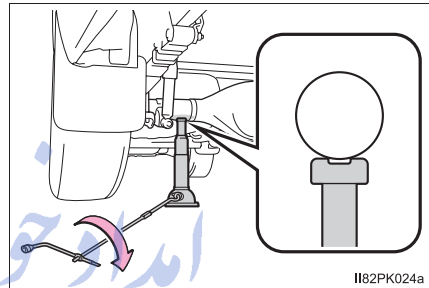

- 7 Remove all the wheel nuts and the tire.

When resting the tire on the ground, place the tire so that the wheel design faces up to avoid scratching the wheel surface.

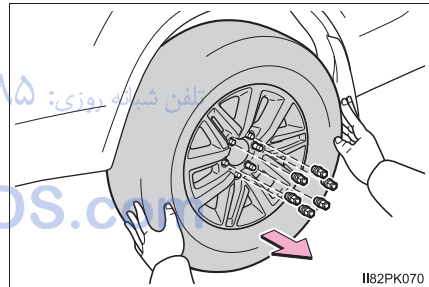

 **WARNING****■ Replacing a flat tire**

- Observe the following precautions.

Failure to do so may result in serious injury:

- Lower the spare tire completely to the ground before removing it from under the vehicle.
- Do not try to remove the wheel ornament by hand. Take due care in handling the ornament to avoid unexpected personal injury.
- Do not touch the disc wheels or the area around the brakes immediately after the vehicle has been driven.

After the vehicle has been driven the disc wheels and the area around the brakes will be extremely hot. Touching these areas with hands, feet or other body parts while changing a tire, etc. may result in burns.

- Failure to follow these precautions could cause the wheel nuts to loosen and the tire to fall off, resulting in death or serious injury.
 - Have the wheel nuts tightened with a torque wrench to 105 N•m (10.7 kgf•m, 77 ft•lbf) as soon as possible after changing wheels.
 - Do not attach a heavily damaged wheel ornament, as it may fly off the wheel while the vehicle is moving.
 - When installing a tire, only use wheel nuts that have been specifically designed for that wheel.
 - If there are any cracks or deformations in the bolt screws, nut threads or bolt holes of the wheel, have the vehicle inspected by any authorized Toyota dealer or repairer, or another duly qualified and equipped professional.
 - When installing the wheel nuts, be sure to install them with the tapered ends facing inward. (→P. 529)

Installing the spare tire

- 1 Remove any dirt or foreign matter from the wheel contact surface.

If foreign matter is on the wheel contact surface, the wheel nuts may loosen while the vehicle is in motion, causing the tire to come off.

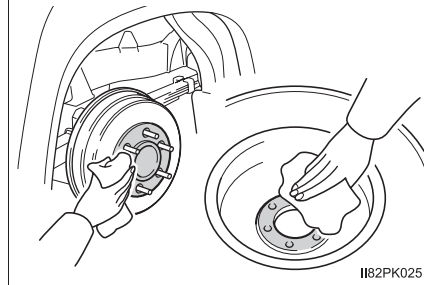

- 2 Install the tire and loosely tighten each wheel nut by hand by approximately the same amount.

When replacing a steel wheel with a steel wheel, tighten the wheel nuts until the tapered portion comes into loose contact with the disc wheel seat.

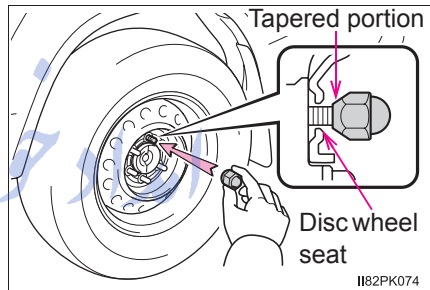

When replacing an aluminum wheel with a steel wheel, tighten the wheel nuts until the tapered portion comes into loose contact with the disc wheel seat.

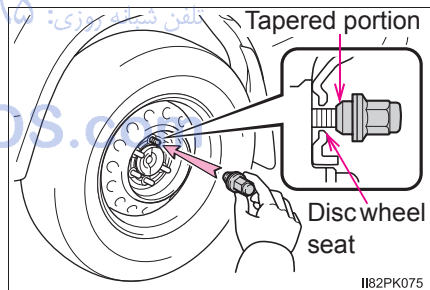

When replacing an aluminum wheel with an aluminum wheel, turn the wheel nuts until the washers come into contact with the disc wheel.

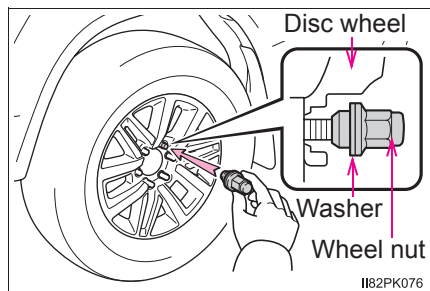

- 3 Lower the vehicle.

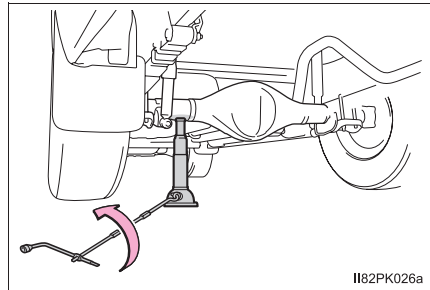

- 4 Firmly tighten each wheel nut two or three times in the order shown in the illustration.

Tightening torque:

105 N•m (10.7 kgf•m, 77 ft•lbf)

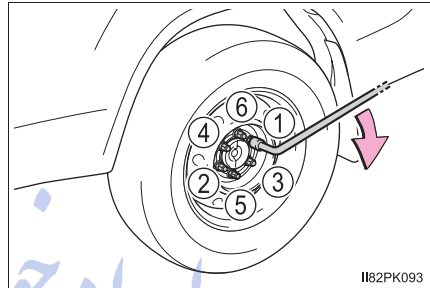

- 5 Vehicles with spare tire of the same wheel type as the installed tires: Reinstall the wheel ornament.

► Type A

Align the cutout of the wheel ornament with the valve stem as shown.

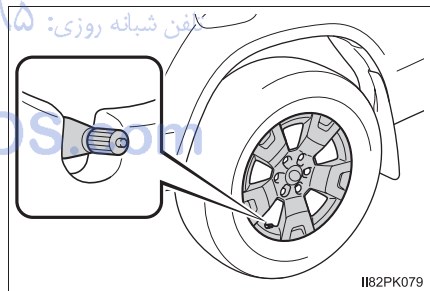

► Type B

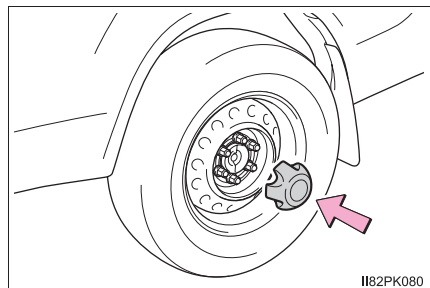

► Type C

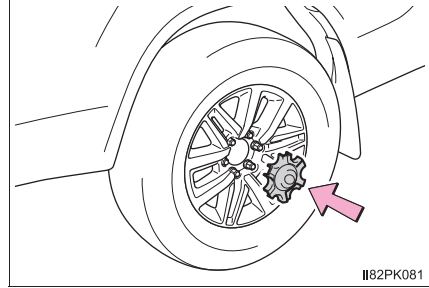

I182PK081

 **WARNING**
 **Stowing the flat tire**

Failure to follow steps listed under stowing the tire may result in damage to the spare tire carrier and loss of the tire, which could result in death or serious injury.

Stowing the flat tire, jack and all tools

- 1 Lay down the tire with the valve stem facing up and install the holding bracket, inserting the claw into the wheel lug nut hole. Turn the jack handle extension clockwise to take up slack in the chain.

Then, check to ensure the claw is in the wheel lug nut hole and the holding bracket is centered in the wheel hub.

- ① Holding bracket
- ② Claw

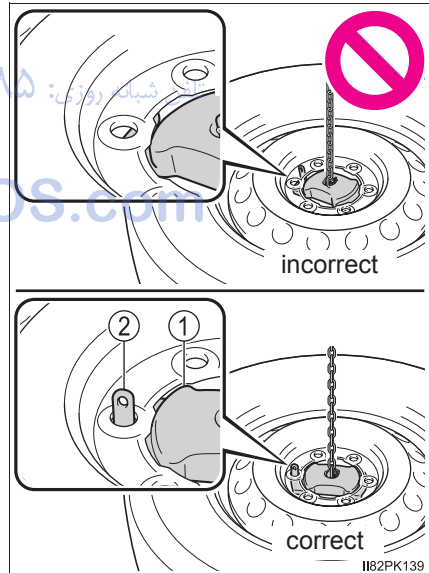

I182PK139

2 Raise the tire.

While raising, secure the tire, taking care that the tire goes straight up without catching on any surrounding part, to prevent it from flying forward during a collision or sudden braking.

After the tire goes half way up, check that the suspended chain is able to enter the tire hole, for proper storage.

Tightening torque:

37.0 N•m (3.8 kgf•m, 27.3 ft•lbf)

3 Confirm that the tire is not loose after tightening:

- ① Push and pull the tire
- ② Try rotating

Visually check to ensure the tire is not hung on surrounding parts.

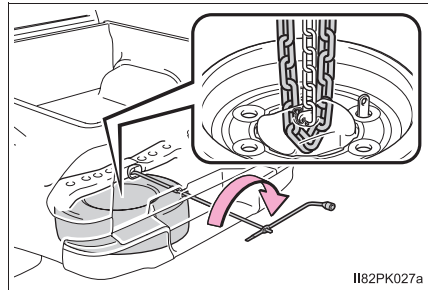

I182PK027a

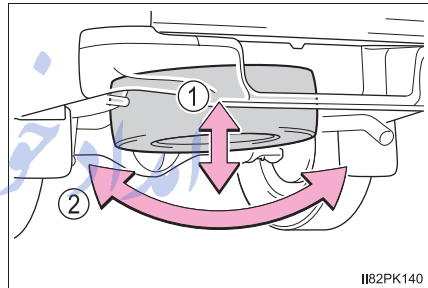

I182PK140

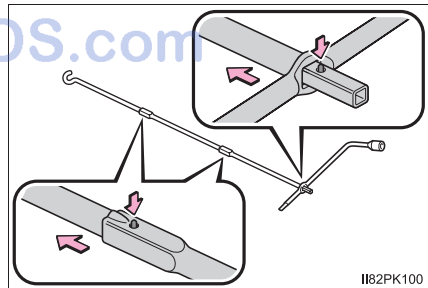

If looseness or misassembly exists, repeat step **2** and step **3**.

4 Repeat step **3**, any time the tire is lowered or disturbed.**5** Push in the projection on the jack handle and disassemble the jack handle end, jack handle extensions and wheel nut wrench.

I182PK100

6 Stow the tools and jack securely.

■ Certification for the jack

DECLARATION OF CONFORMITY	
 ATC AOYAMA THAI CO., LTD.	For 
Screw Jack	
Models: 09111-0K151, 09111-0K161 & 09111-0K181 for Toyota	
Manufactured by Aoyama Thai Co.,Ltd. 64/49 Mu4, Eastern Seaboard Industrial Estate, Pluakdaeng, Rayong 21140 Thailand	
Means of Conformity The Product is in conformity with EC law as approximated by the following directives: Machinery Directive 2006/42/EC based on Technical Documentation File No. 2190 Issue 1, Revision 2	
Standards used as guidance Machinery Directive ISO12100: 2010 Limited reference to EN 1494:2000/A1:2008 تلفن Refer to complete listing in TF	
Technical File compiled from manufacturers documentation and held in the EU, on behalf of the manufacturer by Element Materials Technology Warwick Ltd 100 Frobisher Business Park, Leigh Sinton Road, Malvern, Worcestershire, WR14 1BX United Kingdom	
Signature of Responsible Person: Mr. Hirohisa Kajita Managing Director	
	
Date:	1st April 2016
Certificate No.	TRA-016130-00B DofC Issue 3

 **WARNING**

■ **After using the tools and jack**

Before driving, make sure all the tools and jack are securely in place in their storage location to reduce the possibility of personal injury during a collision or sudden braking.

 **NOTICE**

■ **When stowing the flat tire**

Ensure that there is no object caught between the tire and the vehicle underbody.

■ **When assembling the jack handle extension**

Insert the square head securely until you hear a click. Otherwise the extension may come off and it may damage the paint or vehicle body.

■ **When replacing the tires (vehicles with tire pressure warning system)**

When removing or fitting the wheels, tires or the tire pressure warning valve and transmitter, contact any authorized Toyota dealer or repairer, or another duly qualified and equipped professional as the tire pressure warning valve and transmitter may be damaged if not handled correctly.

■ **To avoid damage to the tire pressure warning valves and transmitters (vehicles with tire pressure warning system)**

When a tire is repaired with liquid sealants, the tire pressure warning valve and transmitter may not operate properly. If a liquid sealant is used, contact any authorized Toyota dealer or repairer, or another duly qualified and equipped professional as soon as possible. Make sure to replace the tire pressure warning valve and transmitter when replacing the tire. (→P. 519)

If the engine will not start

If the engine will not start even though correct starting procedures are being followed (→P. 236, 239), consider each of the following points:

The engine will not start even though the starter motor operates normally.

One of the following may be the cause of the problem:

- There may not be sufficient fuel in the vehicle's tank.
Gasoline engine: Refuel the vehicle.
Diesel engine: →P. 616
- The engine may be flooded. (gasoline engine)
Try to restart the engine again following correct starting procedures.
(→P. 236, 239)
- There may be a malfunction in the engine immobilizer system.
(if equipped: →P. 107)

The starter motor turns over slowly, the interior lights and headlights are dim, or the horn does not sound or sounds at a low volume.

One of the following may be the cause of the problem:

- The battery may be discharged. (→P. 607)
- The battery terminal connections may be loose or corroded.

The starter motor does not turn over (vehicles with smart entry & start system).

The engine starting system may be malfunctioning due to an electrical problem such as an open circuit or a blown fuse. However, an interim measure is available to start the engine. (→P. 602)

The starter motor does not turn over, the interior lights and headlights do not turn on, or the horn does not sound.

One of the following may be the cause of the problem:

- One or both of the battery terminals may be disconnected.
- The battery may be discharged. (→P. 607)
- There may be a malfunction in the steering lock system. (vehicles with smart entry & start system)

Contact any authorized Toyota dealer or repairer, or another duly qualified and equipped professional if the problem cannot be repaired, or if repair procedures are unknown.

Emergency start function (vehicles with smart entry & start system)

When the engine does not start, the following steps can be used as an interim measure to start the engine if the engine switch is functioning normally.

- 1 Set the parking brake.
- 2 Shift the shift lever to P (automatic transmission) or N (manual transmission).
- 3 Turn the engine switch to ACCESSORY mode.
- 4 Press and hold the engine switch for about 15 seconds while depressing the brake pedal and clutch pedal (manual transmission) firmly.

Even if the engine can be started using the above steps, the system may be malfunctioning. Have the vehicle inspected by your any authorized Toyota dealer or repairer, or another duly qualified and equipped professional.

If the electronic key does not operate properly (vehicles with smart entry & start system)

If communication between the electronic key and vehicle is interrupted (→P. 173) or the electronic key cannot be used because the battery is depleted, the smart entry & start system and wireless remote control cannot be used. In such cases, the doors can be opened and the engine can be started by following the procedure below.

Locking and unlocking the doors

Use the mechanical key (→P. 151) in order to perform the following operations:

- ① Locks all doors
- ② Unlocks all doors

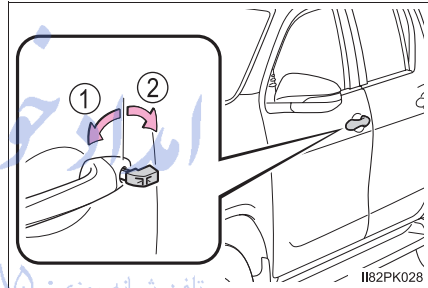

FarmaSOS.com

Starting the engine

► Automatic transmission

- 1 Ensure that the shift lever is in P and depress the brake pedal.
- 2 Touch the area behind the lock button and unlock button on the electronic key to the engine switch.

When the electronic key is detected, a buzzer sounds and the engine switch will turn to IGNITION ON mode.

When the smart entry & start system is deactivated in customization setting, the engine switch will turn to ACCESSORY mode.

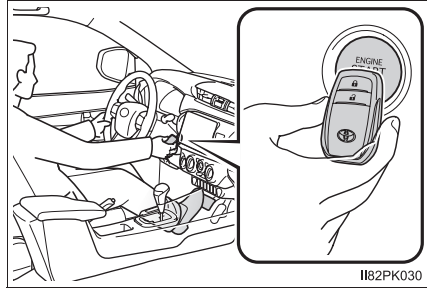

- 3 Firmly depress the brake pedal.

A message indicating how to start the engine will be displayed on the multi-information display.

- 4 Press the engine switch.

In the event that the engine still cannot be started, contact any authorized Toyota dealer or repairer, or another duly qualified and equipped professional.

► Manual transmission

1 Ensure that the shift lever is in N and depress the clutch pedal.

2 Touch the area behind the lock button and unlock button on the electronic key to the engine switch.

When the electronic key is detected, a buzzer sounds and the engine switch will turn to IGNITION ON mode.

When the smart entry & start system is deactivated in customization setting, the engine switch will turn to ACCESSORY mode.

3 Firmly depress the clutch pedal.

A message indicating how to start the engine will be displayed on the multi-information display.

4 Press the engine switch.

In the event that the engine still cannot be started, contact any authorized Toyota dealer or repairer, or another duly qualified and equipped professional.

تلفن شبانه روزی: ۰۲۱-۸۸۸۶۲۰۸۵

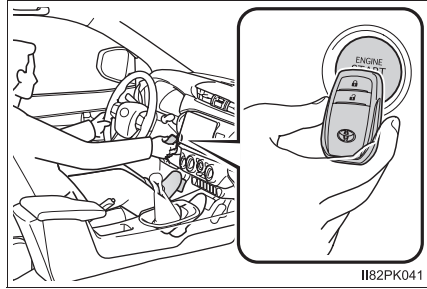

FarmaSOS.com

■ Stopping the engine

Shift the shift lever to P (automatic transmission) or N (manual transmission) and press the engine switch as you normally do when stopping the engine.

■ Replacing the key battery

As the above procedure is a temporary measure, it is recommended that the electronic key battery be replaced immediately when the battery is depleted. (→P. 532)

■ Alarm (vehicles with alarm for Kazakhstan and Morocco)

Using the mechanical key to lock the doors will not set the alarm system. If a door is unlocked using the mechanical key when the alarm system is set, the alarm may be triggered.

■ Changing engine switch modes

Release the brake pedal (automatic transmission) or clutch pedal (manual transmission) and press the engine switch in step 3 above.

The engine does not start and modes will be changed each time the switch is pressed. (→P. 242)

■ When the electronic key does not work properly

- Make sure that the smart entry & start system has not been deactivated in the customization setting. If it is off, turn the function on. (Customizable features: →P. 648)
- Check if battery-saving mode is set. If it is set, cancel the function. (→P. 171)

تلفن شبانه روزی: ۰۲۱-۸۸۸۶۲۰۸۵

FarmaSOS.com

If the vehicle battery is discharged

The following procedures may be used to start the engine if the vehicle's battery is discharged.

You can also call any authorized Toyota dealer or repairer, or another duly qualified and equipped professional or a qualified repair shop.

If you have a set of jumper (or booster) cables and a second vehicle with a 12-volt battery, you can jump start your vehicle by following the steps below.

- 1 Open the hood. (→P. 497)
 - 2 Connect the jumper cables according to the following procedure:
 - ① Connect a positive jumper cable clamp to the positive (+) battery terminal on your vehicle.
 - ② Connect the clamp on the other end of the positive cable to the positive (+) battery terminal on the second vehicle.
 - ③ Connect a negative cable clamp to the negative (-) battery terminal on the second vehicle.
 - ④ Connect the clamp at the other end of the negative cable to a solid, stationary, unpainted metallic point away from the battery and any moving parts, as shown in the illustration.
- ▶ 2TR-FE engine

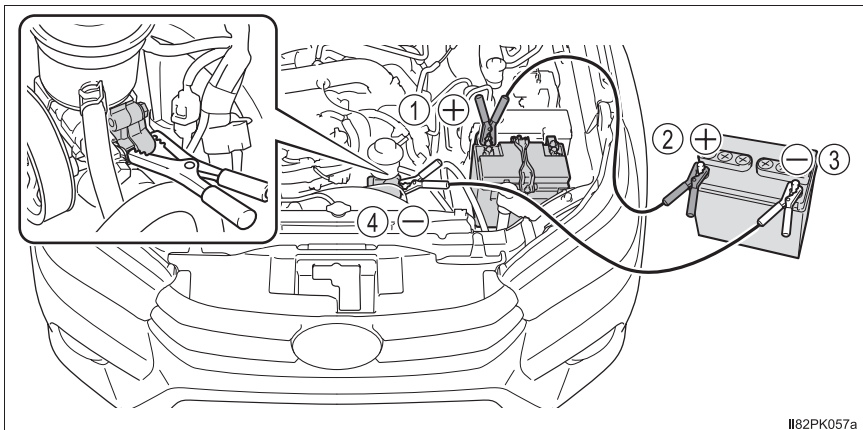

I182PK057a

► 1GD-FTV and 2GD-FTV engines

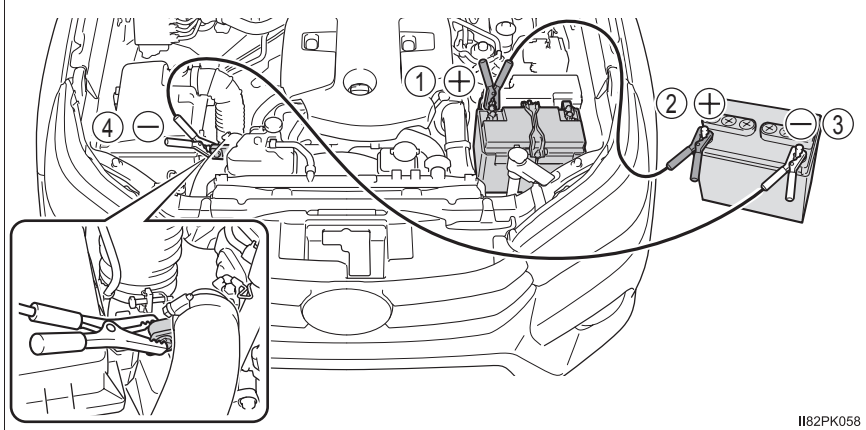

► 2KD-FTV engine

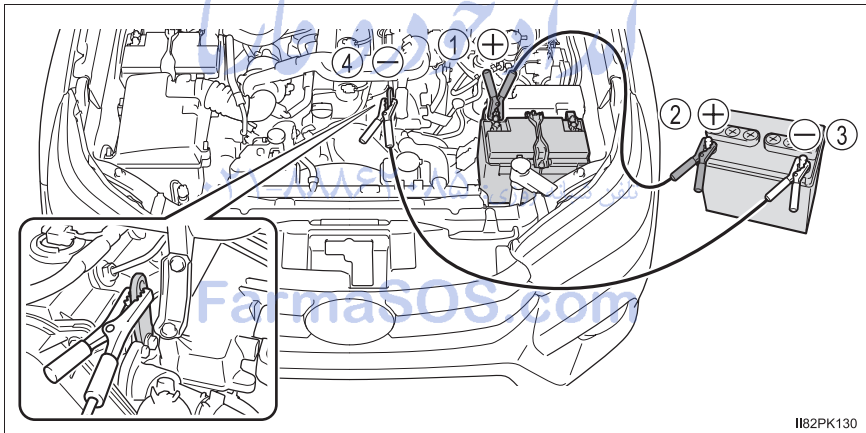

- 3 Start the engine of the second vehicle. Increase the engine speed slightly and maintain at that level for approximately 5 minutes to recharge the battery of your vehicle.
- 4 Vehicles with smart entry & start system: Open and close any of the doors with the engine switch off.
- 5 Maintain the engine speed of the second vehicle and start the engine of your vehicle by turning the engine switch to the "ON" position (vehicles without smart entry & start system) or IGNITION ON mode (vehicles with smart entry & start system).
- 6 Once the vehicle's engine has started, remove the jumper cables in the exact reverse order from which they were connected.

Once the engine starts, have the vehicle inspected at any authorized Toyota dealer or repairer, or another duly qualified and equipped professional as soon as possible.

■ **Starting the engine when the battery is discharged (vehicles with automatic transmission)**

The engine cannot be started by push-starting.

■ **To prevent battery discharge**

- Turn off the headlights and the audio system while the engine is off. (Vehicles with Stop & Start system: Except when the engine is stopped due to the Stop & Start system)
- Turn off any unnecessary electrical components when the vehicle is running at a low speed for an extended period, such as in heavy traffic.

■ **When the battery is removed or discharged**

- Information stored in the ECU is cleared. When the battery is depleted, have the vehicle inspected at any authorized Toyota dealer or repairer, or another duly qualified and equipped professional.
- The power windows may not close normally. In this case, initialize the power windows. (if equipped) (→P. 202)

■ **Charging the battery**

The electricity stored in the battery will discharge gradually even when the vehicle is not in use, due to natural discharge and the draining effects of certain electrical appliances. If the vehicle is left for a long time, the battery may discharge, and the engine may be unable to start. (The battery recharges automatically during driving.)

■ When recharging or replacing the battery (vehicles with smart entry & start system)

- In some cases, it may not be possible to unlock the doors using the smart entry & start system when the battery is discharged. Use the wireless remote control or the mechanical key to lock or unlock the doors.
- The engine may not start on the first attempt after the battery has recharged but will start normally after the second attempt. This is not a malfunction.
- The engine switch mode is memorized by the vehicle. When the battery is reconnected, the system will return to the mode it was in before the battery was discharged. Before disconnecting the battery, turn the engine switch off. If you are unsure what mode the engine switch was in before the battery discharged, be especially careful when reconnecting the battery.
- Vehicles with Stop & Start system: After charging the battery or reconnecting the battery terminals, the Stop & Start system may not automatically stop the engine for approximately 5 to 40 minutes.

■ When exchanging the battery

- Use a battery that conforms to European regulations.
- Use a battery with the same case size as the previous battery and an equivalent 20 hour rate capacity (20HR) or greater.
 - If the sizes differ, the battery cannot be properly secured.
 - If the 20 hour rate capacity is low, even if the time period where the vehicle is not used is a short time, the battery may discharge and the engine may not be able to start.
- Vehicles with Stop & Start system: Use a battery specified for use with the Stop & Start system and equivalent to a genuine battery. If an unsupported battery is used, Stop & Start system functions may be restricted to protect the battery.

Also, battery performance may decrease and the engine may not be able to restart. Contact any authorized Toyota dealer or repairer, or another duly qualified and equipped professional for details.

- For details, consult any authorized Toyota dealer or repairer, or another duly qualified and equipped professional.

 **WARNING**
■ When removing the battery terminals

Always remove the negative (-) terminal first. If the positive (+) terminal contacts any metal in the surrounding area when the positive (+) terminal is removed, a spark may occur, leading to a fire in addition to electrical shocks and death or serious injury.

■ Avoiding battery fires or explosions

Observe the following precautions to prevent accidentally igniting the flammable gas that may be emitted from the battery:

- Make sure each jumper cable is connected to the correct terminal and that it is not unintentionally in contact with any other than the intended terminal.
- Do not allow the other end of the jumper cable connected to the “+” terminal to come into contact with any other parts or metal surfaces in the area, such as brackets or unpainted metal.
- Do not allow the + and - clamps of the jumper cables to come into contact with each other.
- Do not smoke, use matches, cigarette lighters or allow open flame near the battery.

■ Battery precautions

The battery contains poisonous and corrosive acidic electrolyte, while related parts contain lead and lead compounds. Observe the following precautions when handling the battery:

- When working with the battery, always wear safety glasses and take care not to allow any battery fluids (acid) to come into contact with skin, clothing or the vehicle body.
- Do not lean over the battery.
- In the event that battery fluid comes into contact with the skin or eyes, immediately wash the affected area with water and seek medical attention. Place a wet sponge or cloth over the affected area until medical attention can be received.
- Always wash your hands after handling the battery support, terminals, and other battery-related parts.
- Do not allow children near the battery.

 **WARNING****■ When exchanging the battery**

- When the vent plug and indicator are close to the hold down bracket, the battery fluid (sulfuric acid) may leak.
- For information regarding battery replacement, contact any authorized Toyota dealer or repairer, or another duly qualified and equipped professional.

■ To prevent damage to the vehicle (vehicles with manual transmission)

Do not pull- or push-start the vehicle as the three-way catalytic converter or catalytic converter may overheat and become a fire hazard.

 **NOTICE****■ When handling jumper cables**

When connecting the jumper cables, ensure that they do not become entangled in the cooling fan or belt.

امداد خودرو فارما

تلفن شبانه روزی: ۰۲۱-۸۸۸۶۲۰۸۵

FarmaSOS.com

If your vehicle overheats

The following may indicate that your vehicle is overheating.

- The needle of the engine coolant temperature gauge (→P. 128) enters the red zone or a loss of engine power is experienced. (For example, the vehicle speed does not increase.)
- Steam comes out from under the hood.

Correction procedures

- 1 Stop the vehicle in a safe place and turn off the air conditioning system, and then stop the engine.
- 2 If you see steam:
Carefully lift the hood after the steam subsides.
If you do not see steam:
Carefully lift the hood.
- 3 After the engine has cooled down sufficiently, inspect the hoses and radiator core (radiator) for any leaks.

① Radiator

② Cooling fan

If a large amount of coolant leaks, immediately contact any authorized Toyota dealer or repairer, or another duly qualified and equipped professional.

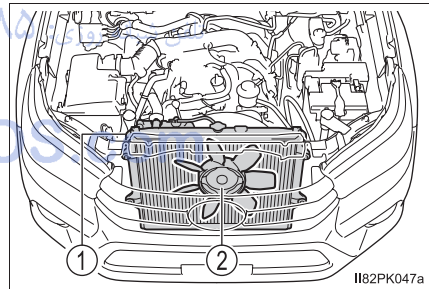

- 4 The coolant level is satisfactory if it is between the “F” and “L” lines on the reservoir.

- ① Reservoir
- ② “F” line
- ③ “L” line
- ④ Radiator cap (if equipped)

► Gasoline engine

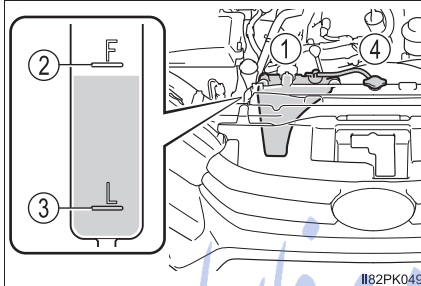

II82PK049

► Diesel engine

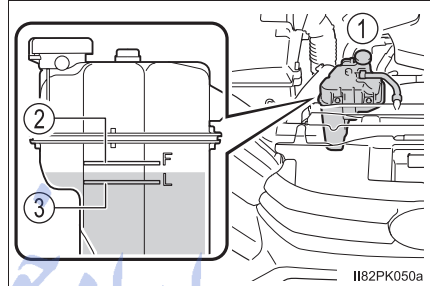

II82PK050a

- 5 Add engine coolant if necessary. (→P. 636)

Water can be used in an emergency if engine coolant is unavailable.

► Gasoline engine

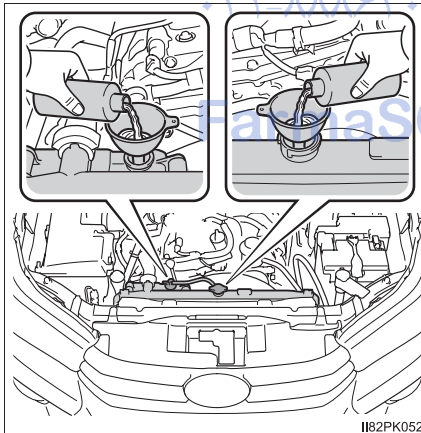

II82PK052

► Diesel engine

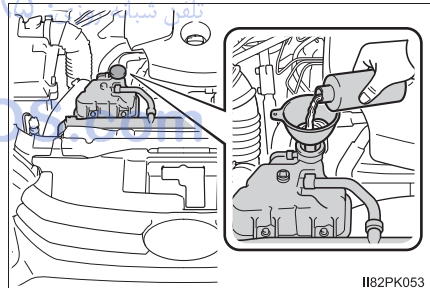

II82PK053

- 6 Start the engine to check that the radiator cooling fan operates and to check for coolant leaks from the radiator or hoses.
- 7 If the fan is not operating:
Stop the engine immediately and contact any authorized Toyota dealer or repairer, or another duly qualified and equipped professional.
- If the fan is operating:
Have the vehicle inspected at the nearest authorized Toyota dealer or repairer, or another duly qualified and equipped professional.

 **WARNING**

■ **When inspecting under the hood of your vehicle**

Observe the following precautions.

Failure to do so may result in serious injury such as burns.

- If steam is seen coming from under the hood, do not open the hood until the steam has subsided. The engine compartment may be very hot.
- Keep hands and clothing (especially a tie, a scarf or a muffler) away from the fans and belts. Failure to do so may cause the hands or clothing to be caught, resulting in serious injury.
- Do not loosen the radiator cap or the coolant reservoir cap while the engine and radiator are hot. High temperature steam or coolant could spray out.

 **NOTICE**

■ **When adding engine coolant**

Add coolant slowly after the engine has cooled down sufficiently. Adding cool coolant to a hot engine too quickly can cause damage to the engine.

■ **To prevent damage to the cooling system**

Observe the following precautions:

- Avoid contaminating the coolant with foreign matter (such as sand or dust etc.).
- Do not use any coolant additive.

If you run out of fuel and the engine stalls (diesel engine only)

If you run out of fuel and the engine stalls:

- 1 Refuel your vehicle.
- 2 To bleed the fuel system, operate the priming pump until you feel more resistance.

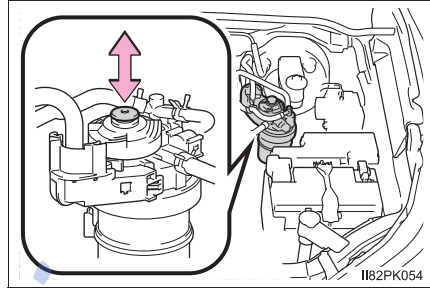

- 3 Start the engine. (→P. 236, 239)

If the engine does not start after the above steps have been performed, wait for 10 seconds and try steps 2 and 3 again. If the engine still does not start, contact any authorized Toyota dealer or repairer, or another duly qualified and equipped professional.

After starting the engine, depress the accelerator pedal lightly until the engine runs smoothly. ۸۸۸۶۲۰۸۵ تلفن شبانه روزی:

NOTICE

■ When restarting the engine

- Do not crank the engine before refueling and operating the priming pump. This may damage the engine and fuel system.
- Do not crank the engine for more than 30 seconds at a time. This may overheat the starter and wiring system.

If the vehicle becomes stuck

Carry out the following procedures if the tires spin or the vehicle becomes stuck in mud, dirt or snow:

- 1 Stop the engine. Set the parking brake and shift the shift lever to P (automatic transmission) or N (manual transmission).
- 2 Remove the mud, snow or sand from around the stuck tire.
- 3 Place wood, stones or some other material under the tires to help provide traction.
- 4 Restart the engine.
- 5 Vehicles with rear differential lock system: Lock the rear differential. (→P. 339)
- 6 Shift the shift lever to the D or R position (automatic transmission) or 1 or R position (manual transmission) and carefully apply the accelerator to free the vehicle.

■ When it is difficult to free the vehicle (vehicles with TRC/A-TRC system)

Press  to turn off TRC/A-TRC.

► Vehicles without multi-information display

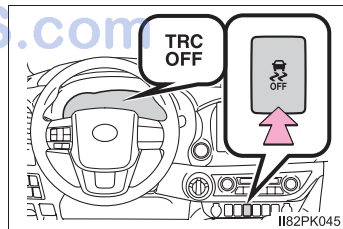

► Vehicles with multi-information display

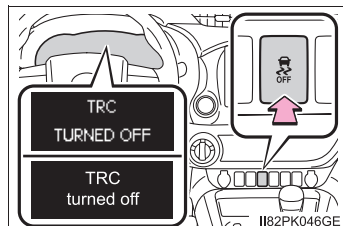

 **WARNING****■ When attempting to free a stuck vehicle**

If you choose to push the vehicle back and forth to free it, make sure the surrounding area is clear to avoid striking other vehicles, objects or people. The vehicle may also lunge forward or lunge back suddenly as it becomes free. Use extreme caution.

■ When shifting the shift lever

For vehicles with automatic transmission, be careful not to shift the shift lever with the accelerator pedal depressed.

This may lead to unexpected rapid acceleration of the vehicle that may cause an accident resulting in death or serious injury.

 **NOTICE****■ To avoid damage to the transmission and other components**

- Avoid spinning the wheels and depressing the accelerator pedal more than necessary.
- If the vehicle remains stuck even after these procedures are performed, the vehicle may require towing to be freed.
- Vehicles with automatic transmission: When a warning message for the automatic transmission fluid temperature is displayed while attempting to free a stuck vehicle, immediately remove your foot from the accelerator pedal and wait until the warning message disappears. Otherwise, the transmission may become damaged. (→P. 253)

Vehicle specifications**9****9-1. Specifications**

Maintenance data (fuel, oil level, etc.).....	620
Fuel information	645

9-2. Customization

Customizable features	648
-----------------------------	-----

9-3. Initialization

Items to initialize	655
---------------------------	-----

امداد خودرو فارما

تلفن شبانه روزی: ۰۲۱-۸۸۸۶۲۰۸۵

FarmaSOS.com

Maintenance data (fuel, oil level, etc.)

Dimensions

Overall length	Without rear bumper	5265 mm (207.3 in.) ^{*2} 5285 mm (208.1 in.) ^{*3}
	With rear bumper	5335 mm (210.0 in.) ^{*4} 5330 mm (209.8 in.) ^{*5}
Overall width	Without over fender	1800 mm (70.9 in.) ^{*6} 1815 mm (71.5 in.) ^{*7}
	With over fender	1855 mm (73.0 in.)
Overall height ^{*1}	Single-cab models	1795 mm (70.7 in.)
	Smart-cab models	1810 mm (71.3 in.)
	Double-cab models	1815 mm (71.5 in.)
Wheelbase		3090 mm (121.7 in.)
Front tread		1505 mm (59.3 in.) ^{*8} 1495 mm (58.9 in.) ^{*9} 1535 mm (60.4 in.) ^{*10}
		1520 mm (59.8 in.) ^{*8} 1510 mm (59.4 in.) ^{*9} 1550 mm (61.0 in.) ^{*10}

*1: Unladen vehicle

*2: With tailgate type A (→P. 167)

*3: With tailgate type B (→P. 167)

*4: Without the front steel bumper

*5: With the front steel bumper

*6: Without side step

*7: With side step

*8: With 205R16C tires

*9: With 225/70R17C tires

*10: With 265/65R17 or 265/60R18 tires

Weights*

Gross vehicle mass	Single-cab models	4WD models	3080 kg (6790 lb.)	
		Pre Runner	2950 kg (6504 lb.)	
	Smart-cab models	4WD models	3150 kg (6945 lb.)	
		Pre Runner	3000 kg (6614 lb.)	
	Double-cab models	4WD models	2910 kg (6415 lb.)* ¹ 3210 kg (7077 lb.)* ²	
		Pre Runner	2810 kg (6195 lb.)* ³ 3050 kg (6724 lb.)* ⁴	
Maximum permissible axle capacity	Front		1420 kg (3131 lb.)	
	Rear	Single-cab models	1850 kg (4079 lb.)	
		Smart-cab models	1920 kg (4233 lb.)	
		Double-cab models	4WD models	1650 kg (3638 lb.)* ¹ 1920 kg (4233 lb.)* ²
			Pre Runner	1650 kg (3638 lb.)* ³ 1920 kg (4233 lb.)* ⁴

*: Models for model code destination W (See "Checking your vehicle's model" if you are not sure of which model your vehicle is. [→P. 11])

Drawbar load		Single-cab models	4WD models	140 kg (309 lb.)
			Pre Runner	115 kg (254 lb.)
		Smart-cab models	4WD models	140 kg (309 lb.) ^{*6}
			Pre Runner	130 kg (287 lb.) ^{*7}
		Double-cab models	4WD models	120 kg (265 lb.)
			Pre Runner	130 kg (287 lb.)
Towing capacity	Without brake			750 kg (1653 lb.)
	With brake	Single-cab models	4WD models	3500 kg (7716 lb.)
			Pre Runner	2800 kg (6173 lb.)
		Smart-cab models	4WD models	3500 kg (7716 lb.) ^{*6}
			Pre Runner	3200 kg (7055 lb.) ^{*7}
		Double-cab models	4WD models	3000 kg (6614 lb.)
			Pre Runner	3200 kg (7055 lb.)
			Pre Runner	2800 kg (6173 lb.) ^{*3}
		Pre Runner	3000 kg (6614 lb.) ^{*4}	

*1: For Russia, Ukraine, EURO V and VI models^{*5} for Israel, and EURO V models^{*5} for Turkey

*2: Except for Russia, Ukraine, EURO V and VI models^{*5} for Israel, and EURO V models^{*5} for Turkey

*3: For EURO V models^{*5} for Turkey

*4: Except for EURO V models^{*5} for Turkey

*5: EURO V and VI are emission standards. If it is not clear that your vehicle meets relevant standards, contact any authorized Toyota dealer or repairer, or another duly qualified and equipped professional.

*6: Vehicles without rear seat cushion and GUN125L-CNF5HW3 model*⁸

*7: Vehicles with rear seat cushion except for GUN125L-CNF5HW3 model*⁸

*8: The model code is indicated on the manufacturer's plate or label.
(→P. 623)

Vehicle identification

■ Vehicle identification number

The vehicle identification number (VIN) is the legal identifier for your vehicle. This is the primary identification number for your Toyota. It is used in registering the ownership of your vehicle.

This number is stamped on the rear right frame.

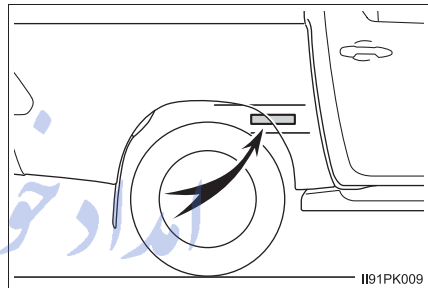

Single-cab models (models made in South Africa*):
This number is also on the manufacturer's label.

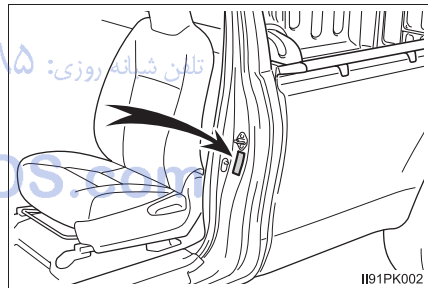

Smart-cab models (models made in South Africa*):
This number is also on the manufacturer's label.

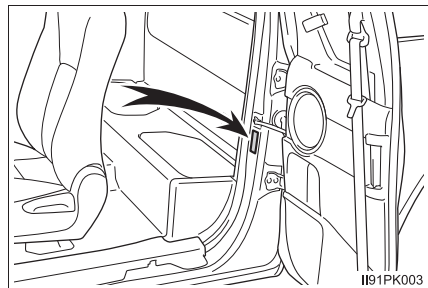

Double-cab models (models made in South Africa*):

This number is also on the manufacturer's label.

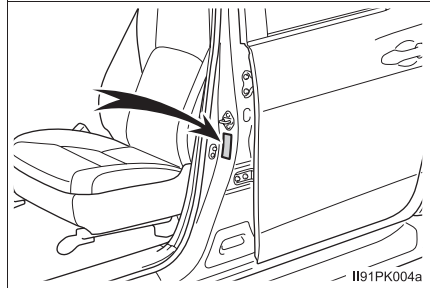

Models made in Thailand*:

This number is also on the manufacturer's plate.

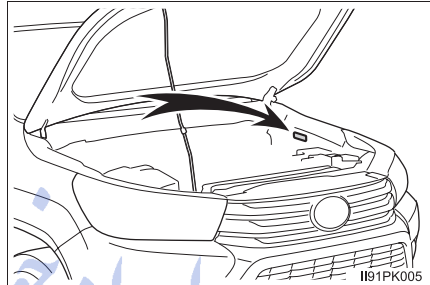

Models for model code destination V*:

This number is also on the top left of the instrument panel.

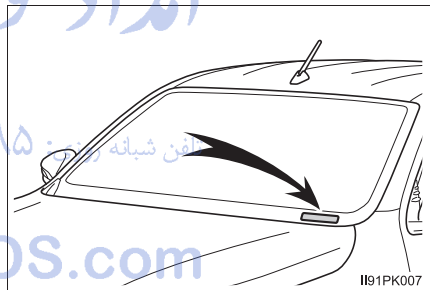

*: See "Checking your vehicle's model" if you are not sure of which model your vehicle is. (→P. 11)

■ Engine number

The engine number is stamped on the engine block as shown.

▶ 2TR-FE engine

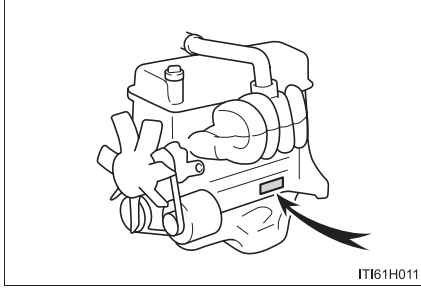

▶ 1GD-FTV and 2GD-FTV engines

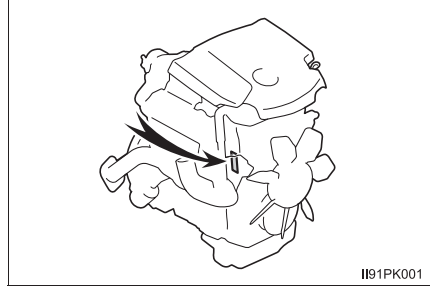

▶ 2KD-FTV engine



Engine

▶ 2TR-FE engine

Model	2TR-FE
Type	4 cylinder in line, 4 cycle, gasoline
Bore and stroke	95.0 × 95.0 mm (3.74 × 3.74 in.)
Displacement	2694 cm ³ (164.4 cu.in.)
Valve clearance	Automatic adjustment
Drive belt tension	Automatic adjustment

► 1GD-FTV engine

Model	1GD-FTV
Type	4 cylinder in line, 4 cycle, diesel (with turbocharger)
Bore and stroke	92.0 × 103.6 mm (3.62 × 4.08 in.)
Displacement	2755 cm ³ (168.1 cu.in.)
Valve clearance	Automatic adjustment
Drive belt tension	Automatic adjustment

► 2GD-FTV engine

Model	2GD-FTV
Type	4 cylinder in line, 4 cycle, diesel (with turbocharger)
Bore and stroke	92.0 × 90.0 mm (3.62 × 3.54 in.)
Displacement	2393 cm ³ (146.0 cu.in.)
Valve clearance	Automatic adjustment
Drive belt tension	Automatic adjustment

► 2KD-FTV engine

Model	2KD-FTV
Type	4 cylinder in line, 4 cycle, diesel (with turbocharger)
Bore and stroke	92.0 × 93.8 mm (3.62 × 3.69 in.)
Displacement	2494 cm ³ (152.2 cu.in.)
Valve clearance (engine cold)	Intake: 0.20 — 0.30 mm (0.008 — 0.012 in.) Exhaust: 0.35 — 0.45 mm (0.014 — 0.018 in.)
Drive belt tension	Automatic adjustment

Fuel

▶ Gasoline engine

Fuel type	Unleaded gasoline only
Research Octane Number	91 or higher
Fuel tank capacity (Reference)	80 L (21.1 gal., 17.6 Imp.gal.)

▶ Diesel engine

Fuel type	<ul style="list-style-type: none"> ▶ EU area Diesel fuel conforming to European standard EN590 ▶ Except EU area (except Russia) Diesel fuel only ▶ Except EU area (Russia) Diesel fuel confirming to GOST R52368-2005
Cetane number	48 or higher
Fuel tank capacity (Reference)	80 L (21.1 gal., 17.6 Imp.gal.)

FarmaSOS.com

Lubrication system

- 2TR-FE engine (for EURO IV and V models*1)

Oil capacity (Drain and refill — Reference*2)	
With filter	5.6 L (5.9 qt., 4.9 Imp.qt.)
Without filter	5.3 L (5.6 qt., 4.7 Imp.qt.)

- *1: EURO IV and V are emission standards. If it is not clear that your vehicle meets relevant standards, contact any authorized Toyota dealer or repairer, or another duly qualified and equipped professional.
- *2: The engine oil capacity is a reference quantity to be used when changing the engine oil. Warm up and turn off the engine, wait more than 5 minutes, and check the oil level on the dipstick.

■ Engine oil selection

“Toyota Genuine Motor Oil” is used in your Toyota vehicle. Use Toyota approved “Toyota Genuine Motor Oil” or equivalent to satisfy the following grade and viscosity.

Oil grade:

0W-20, 5W-20, 5W-30 and 10W-30:

API grade SL “Energy-Conserving”, SM “Energy-Conserving” or SN “Resource-Conserving”; or ILSAC multigrade engine oil

15W-40:

API grade SL, SM or SN multigrade engine oil

Recommended viscosity (SAE):

If you use SAE 10W-30 or a higher viscosity engine oil in extremely low temperatures, the engine may become difficult to start, so SAE 0W-20, 5W-20 or 5W-30 engine oil is recommended.

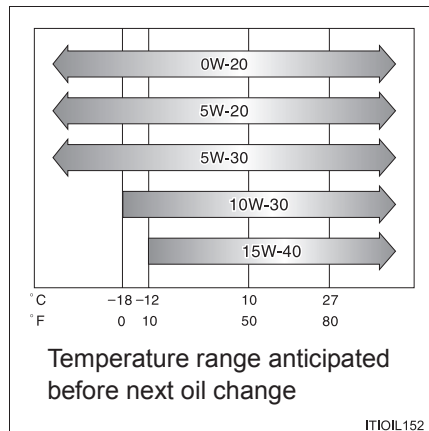

Oil viscosity (0W-20 is explained here as an example):

- The 0W in 0W-20 indicates the characteristic of the oil which allows cold startability. Oils with a lower value before the W allow for easier starting of the engine in cold weather.
- The 20 in 0W-20 indicates the viscosity characteristic of the oil when the oil is at high temperature. An oil with a higher viscosity (one with a higher value) may be better suited if the vehicle is operated at high speeds, or under extreme load conditions.

How to read oil container labels:

Either or both API registered marks are added to some oil containers to help you select the oil you should use.

① API Service Symbol

Top portion: "API SERVICE SN" means the oil quality designation by American Petroleum Institute (API).

Center portion: "SAE 0W-20" means the SAE viscosity grade.

Lower portion: "Resource-Conserving" means that the oil has fuel-saving and environmental protection capabilities.

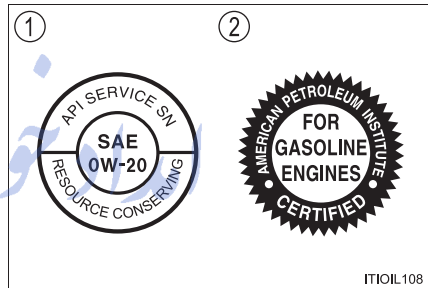

② ILSAC Certification Mark

The International Lubricant Specification Advisory Committee (ILSAC) Certification Mark is displayed on the front of the container.

► 2TR-FE engine (except for EURO IV and V models*1)

Oil capacity (Drain and refill — Reference*2)	
With filter	5.6 L (5.9 qt., 4.9 Imp.qt.)
Without filter	5.3 L (5.6 qt., 4.7 Imp.qt.)

*1: EURO IV and V are emission standards. If it is not clear that your vehicle meets relevant standards, contact any authorized Toyota dealer or repairer, or another duly qualified and equipped professional.

*2: The engine oil capacity is a reference quantity to be used when changing the engine oil. Warm up and turn off the engine, wait more than 5 minutes, and check the oil level on the dipstick.

■ Engine oil selection

“Toyota Genuine Motor Oil” is used in your Toyota vehicle. Use Toyota approved “Toyota Genuine Motor Oil” or equivalent to satisfy the following grade and viscosity.

Oil grade:

0W-20, 5W-20, 5W-30 and 10W-30:

API grade SL “Energy-Conserving”, SM “Energy-Conserving” or SN “Resource-Conserving”; or ILSAC multigrade engine oil

15W-40 and 20W-50:

API grade SL, SM or SN multigrade engine oil

Recommended viscosity (SAE):

If you use SAE 10W-30 or a higher viscosity engine oil in extremely low temperatures, the engine may become difficult to start, so SAE 0W-20, 5W-20 or 5W-30 engine oil is recommended.

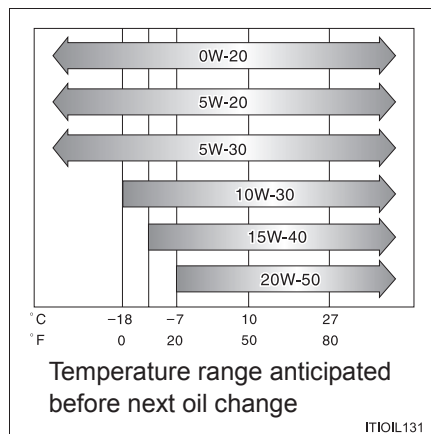

Oil viscosity (0W-20 is explained here as an example):

- The 0W in 0W-20 indicates the characteristic of the oil which allows cold startability. Oils with a lower value before the W allow for easier starting of the engine in cold weather.
- The 20 in 0W-20 indicates the viscosity characteristic of the oil when the oil is at high temperature. An oil with a higher viscosity (one with a higher value) may be better suited if the vehicle is operated at high speeds, or under extreme load conditions.

How to read oil container labels:

Either or both API registered marks are added to some oil containers to help you select the oil you should use.

① API Service Symbol

Top portion: "API SERVICE SN" means the oil quality designation by American Petroleum Institute (API).

Center portion: "SAE 0W-20" means the SAE viscosity grade.

Lower portion: "Resource-Conserving" means that the oil has fuel-saving and environmental protection capabilities.

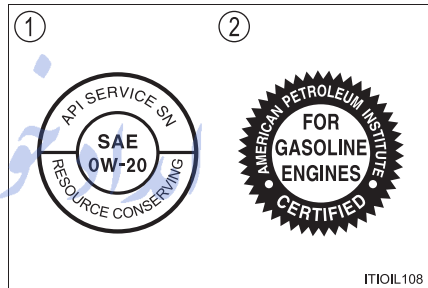

② ILSAC Certification Mark

The International Lubricant Specification Advisory Committee (ILSAC) Certification Mark is displayed on the front of the container.

▶ 1GD-FTV and 2GD-FTV engines (for EURO V and VI models*¹)

Oil capacity (Drain and refill — reference* ²)	
With filter	7.5 L (7.9 qt., 6.6 Imp.qt.)
Without filter	7.0 L (7.4 qt., 6.2 Imp.qt.)

*1: EURO V and VI are emission standards. If it is not clear that your vehicle meets relevant standards, contact any authorized Toyota dealer or repairer, or another duly qualified and equipped professional.

*2: The engine oil capacity is a reference quantity to be used when changing the engine oil. Warm up and turn off the engine, wait more than 5 minutes, and check the oil level on the dipstick.

■ Engine oil selection

“Toyota Genuine Motor Oil” is used in your Toyota vehicle. Toyota recommends the use of approved “Toyota Genuine Motor Oil”. Another motor oil of matching quality can also be used.

Oil grade: ACEA C2



NOTICE

Using engine oil other than ACEA C2 may damage the catalytic converter.

Recommended viscosity (SAE):
SAE 0W-30 is filled into your Toyota vehicle at manufacturing, and the best choice for good fuel economy and good starting in cold weather.

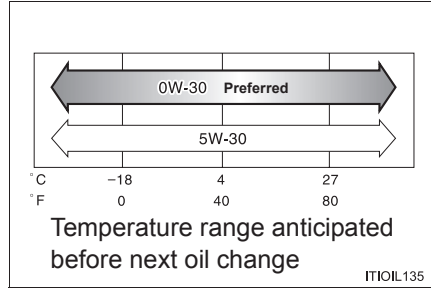

Oil viscosity (0W-30 is explained here as an example):

- The 0W in 0W-30 indicates the characteristic of the oil which allows cold startability. Oils with a lower value before the W allow for easier starting of the engine in cold weather.
- The 30 in 0W-30 indicates the viscosity characteristic of the oil when the oil is at high temperature. An oil with a higher viscosity (one with a higher value) may be better suited if the vehicle is operated at high speeds, or under extreme load conditions.

تلفن شبانه روزی: ۰۲۱-۸۸۸۶۲۰۸۵

FarmaSOS.com

► 1GD-FTV and 2GD-FTV engines (for EURO IV models*1)

Oil capacity (Drain and refill — reference*2)	
With filter	7.5 L (7.9 qt., 6.6 Imp.qt.)
Without filter	7.0 L (7.4 qt., 6.2 Imp.qt.)

*1: EURO IV is an emission standard. If it is not clear that your vehicle meets relevant standards, contact any authorized Toyota dealer or repairer, or another duly qualified and equipped professional.

*2: The engine oil capacity is a reference quantity to be used when changing the engine oil. Warm up and turn off the engine, wait more than 5 minutes, and check the oil level on the dipstick.

■ Engine oil selection

“Toyota Genuine Motor Oil” is used in your Toyota vehicle. Use Toyota approved “Toyota Genuine Motor Oil” or equivalent to satisfy the following grade and viscosity.

Oil grade: API CF-4, CF or ACEA B1

Recommended viscosity (SAE):

SAE 5W-30 is the best choice for good fuel economy and good starting in cold weather.

If you use SAE 10W-30 or a higher viscosity engine oil in extremely low temperatures, the engine may become difficult to start, so SAE 5W-30 engine oil is recommended.

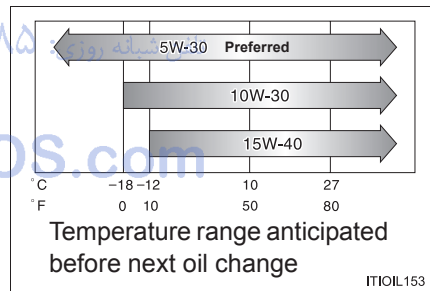

Oil viscosity (5W-30 is explained here as an example):

- The 5W in 5W-30 indicates the characteristic of the oil which allows cold startability. Oils with a lower value before the W allow for easier starting of the engine in cold weather.
- The 30 in 5W-30 indicates the viscosity characteristic of the oil when the oil is at high temperature. An oil with a higher viscosity (one with a higher value) may be better suited if the vehicle is operated at high speeds, or under extreme load conditions.

► 2KD-FTV engine

Oil capacity (Drain and refill — reference*)	
With filter	6.9 L (7.3 qt., 6.1 Imp.qt.)
Without filter	6.6 L (7.0 qt., 5.8 Imp.qt.)

*: The engine oil capacity is a reference quantity to be used when changing the engine oil. Warm up and turn off the engine, wait more than 5 minutes, and check the oil level on the dipstick.

■ Engine oil selection

“Toyota Genuine Motor Oil” is used in your Toyota vehicle. Use Toyota approved “Toyota Genuine Motor Oil” or equivalent to satisfy the following grade and viscosity.

Oil grade: API CF-4, CF or ACEA B1
(You may also use API CE or CD.)

Recommended viscosity (SAE):

If you use SAE 10W-30 or a higher viscosity engine oil in extremely low temperatures, the engine may become difficult to start, so SAE 5W-30 engine oil is recommended.

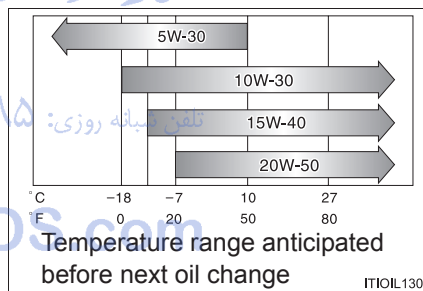

Oil viscosity (10W-30 is explained here as an example):

- The 10W in 10W-30 indicates the characteristic of the oil which allows cold startability. Oils with a lower value before the W allow for easier starting of the engine in cold weather.
- The 30 in 10W-30 indicates the viscosity characteristic of the oil when the oil is at high temperature. An oil with a higher viscosity (one with a higher value) may be better suited if the vehicle is operated at high speeds, or under extreme load conditions.

Cooling system

Capacity	2TR-FE engine		<ul style="list-style-type: none"> ▶ With automatic transmission 8.1 L (8.6 qt., 7.1 Imp.qt.) ▶ With manual transmission 7.8 L (8.2 qt., 6.9 Imp.qt.)
	1GD-FTV and 2GD-FTV engines	EURO IV models*	<ul style="list-style-type: none"> ▶ Without power heater 8.6 L (9.1 qt., 7.6 Imp.qt.) ▶ With power heater 8.9 L (9.4 qt., 7.8 Imp.qt.)
		EURO V models*	<ul style="list-style-type: none"> ▶ With automatic transmission 9.6 L (10.1 qt., 8.4 Imp.qt.) ▶ With manual transmission 9.1 L (9.6 qt., 8.0 Imp.qt.)
		EURO VI models*	<ul style="list-style-type: none"> ▶ With automatic transmission 9.7 L (10.3 qt., 8.5 Imp.qt.) ▶ With manual transmission 9.2 L (9.7 qt., 8.1 Imp.qt.)
	2KD-FTV engine		9.8 L (10.4 qt., 8.6 Imp.qt.)
Coolant type	<p>Use either of the following:</p> <ul style="list-style-type: none"> • “Toyota Super Long Life Coolant” • Similar high-quality ethylene glycol-based non-silicate, non-amine, non-nitrite, and non-borate coolant with long-life hybrid organic acid technology <p>Do not use plain water alone.</p>		

*: EURO IV, V and VI are emission standards. If it is not clear that your vehicle meets relevant standards, contact any authorized Toyota dealer or repairer, or another duly qualified and equipped professional.

Ignition system (gasoline engine)

Spark plug	
Make	DENSO FK20HR-A8
Gap	0.8 mm (0.031 in.)

 NOTICE**■ Iridium-tipped spark plugs**

Use only iridium-tipped spark plugs. Do not adjust the spark plug gap.

امداد خودرو فارما

تلفن شبانه روزی: ۰۲۱-۸۸۸۶۲۰۸۵

FarmaSOS.com

Electrical system

► Vehicles with maintenance type battery

Battery	
Specific gravity reading at 20°C (68°F):	1.250 — 1.290 Fully charged 1.160 — 1.200 Half charged 1.060 — 1.100 Discharged
Charging rates	
Quick charge	15 A max.
Slow charge	5 A max.

► Vehicles with maintenance-free type battery

Battery	
Open voltage at 20°C (68°F):	12.6 — 12.8 V Fully charged 12.2 — 12.4 V Half charged 11.8 — 12.0 V Discharged (Voltage is checked 20 minutes after the engine and all the lights are turned off.)
Charging rates	5 A max.

Automatic transmission

Fluid capacity*	Gasoline engine	8.5 L (9.0 qt., 7.5 Imp.qt.)
	Diesel engine	9.5 L (10.0 qt., 8.4 Imp.qt.)
Fluid type	Toyota Genuine ATF WS	

*: The fluid capacity is the quantity of reference.

If replacement is necessary, contact any authorized Toyota dealer or repairer, or another duly qualified and equipped professional.

NOTICE

■ Automatic transmission fluid type

Using transmission fluid other than “Toyota Genuine ATF WS” may cause deterioration in shift quality, locking up of your transmission accompanied by vibration, and ultimately damage the transmission of your vehicle.

Manual transmission

Oil capacity	5-speed models		2.2 L (2.3 qt., 1.9 Imp.qt.)
	6-speed models	4WD models	2.5 L (2.6 qt., 2.2 Imp.qt.)
		Pre Runner	2.7 L (2.9 qt., 2.4 Imp.qt.)
Oil type			TOYOTA Genuine Manual Transmission Gear Oil API GL-3 (GL-4) or equivalent
Recommended oil viscosity			Above -10°C (14°F): SAE 75W-90, 80W or 80W-90 Below -10°C (14°F): SAE 75W-90

NOTICE

Manual transmission gear oil

Please be aware that depending on the particular characteristics of the gear oil used or the operating conditions, idle sound, shift feeling and/or fuel efficiency may be different or affected. Toyota recommends to use "TOYOTA Genuine Manual Transmission Gear Oil" to achieve optimal performance.

Transfer (4WD models)

Oil capacity	1.0 L (1.1 qt., 0.9 Imp.qt.)
Oil type*	Toyota Genuine Transfer Gear oil LF or equivalent
Recommended oil viscosity	SAE 75W

*: Your Toyota vehicle is filled with "Toyota Genuine Transfer Gear oil LF" at the factory. Use Toyota approved "Toyota Genuine Transfer Gear oil LF" or an equivalent oil of matching quality that satisfies the above specifications. Please contact any authorized Toyota dealer or repairer, or another duly qualified and equipped professional for further details.

Differential

Oil capacity	Front (4WD models)	Without A.D.D.	1.45 L (1.53 qt., 1.28 Imp.qt.)
		With A.D.D.	1.60 L (1.69 qt., 1.41 Imp.qt.)
	Rear	Without rear differential lock system	3.65 L (3.86 qt., 3.21 Imp.qt.) ^{*2} 3.75 L (3.96 qt., 3.30 Imp.qt.) ^{*3}
		With rear differential lock system	3.60 L (3.80 qt., 3.17 Imp.qt.)
Oil type ^{*1} and oil viscosity			Toyota Genuine Differential gear oil LT 75W-85 GL-5 or equivalent

*1: Your Toyota vehicle is filled with “Toyota Genuine Differential Gear Oil” at the factory. Use Toyota approved “Toyota Genuine Differential Gear Oil” or an equivalent oil of matching quality that satisfies the above specifications. Please contact any authorized Toyota dealer or repairer, or another duly qualified and equipped professional for further details.

*2: Models made in Thailand^{*4}

*3: Models made in South Africa^{*4}

*4: See “Checking your vehicle’s model” if you are not sure of which model your vehicle is. (→P. 11) تلفن شبانه روزی: ۰۸۵ ۸۸۶۲۰۸۵

Clutch (vehicles with manual transmission)

Pedal free play	5 — 15 mm (0.2 — 0.6 in.)
Fluid type	SAE J1703 or FMVSS No.116 DOT 3 or SAE J1704 or FMVSS No.116 DOT 4

Brakes

Pedal clearance*1	Left-hand drive vehicles	Without VSC	91 mm (3.6 in.)*3 92 mm (3.6 in.)*4
		With VSC	91 mm (3.6 in.)
	Right-hand drive vehicles		90 mm (3.5 in.)
Pedal free play			1.0 — 6.0 mm (0.04 — 0.24 in.)
Parking brake lever travel*2			7 — 9 clicks
Fluid type			SAE J1703 or FMVSS No.116 DOT 3 or SAE J1704 or FMVSS No.116 DOT 4

*1: Minimum pedal clearance when depressed with a force of 490 N (50 kgf, 110 lbf) while the engine is running

*2: Parking brake lever travel when pulled up with a force of 200 N (20 kgf, 45 lbf)

*3: Without 205R16C tires

*4: With 205R16C tires

Chassis lubrication

Propeller shafts	Front (4WD models)	Spider	Lithium base chassis grease, NLGI No.2
		Slide yoke*1	Molybdenum-disulfide lithium base chassis grease, NLGI No.2 or lithium base chassis grease, NLGI No.2
	Rear	Spider*2	Lithium base chassis grease, NLGI No.2

*1: Models made in Thailand*3

*2: With grease fitting only

*3: See "Checking your vehicle's model" if you are not sure of which model your vehicle is. (→P. 11)

Steering

Free play	Less than 30 mm (1.2 in.)
Power steering fluid type	Automatic transmission fluid DEXRON® II or III

Tires and wheels

► 16 inch tires

Tire size	205R16C 8PR 110/108S		
Tire inflation pressure (Recommended cold tire inflation pressure)	Front wheel kPa (kgf/cm ² or bar, psi)	Rear wheel (unladen) kPa (kgf/cm ² or bar, psi)	Rear wheel (full load) kPa (kgf/cm ² or bar, psi)
	270 (2.7, 39)	270 (2.7, 39)	340 (3.4, 49)
Wheel size	16 × 6J		
Wheel nut torque	105 N•m (10.7 kgf•m, 77 ft•lbf)		

► 17 inch tires (type A)

Tire size	225/70R17C 108/106S		
Tire inflation pressure (Recommended cold tire inflation pressure)	Front wheel kPa (kgf/cm ² or bar, psi)	Rear wheel (unladen) kPa (kgf/cm ² or bar, psi)	Rear wheel (full load) kPa (kgf/cm ² or bar, psi)
	240 (2.4, 35)	240 (2.4, 35)	300 (3.0, 44)
Wheel size	17 × 6J		
Wheel nut torque	105 N•m (10.7 kgf•m, 77 ft•lbf)		

▶ 17 inch tires (type B)

Tire size	265/65R17 112S		
Tire inflation pressure (Recommended cold tire inflation pressure)	Front wheel kPa (kgf/cm ² or bar, psi)	Rear wheel (unladen) kPa (kgf/cm ² or bar, psi)	Rear wheel (full load) kPa (kgf/cm ² or bar, psi)
	Without stop & start system	200 (2.0, 29)	200 (2.0, 29)
With stop & start system	230 (2.3, 33)	230 (2.3, 33)	250 (2.5, 36)
Wheel size	17 × 7 1/2J		
Wheel nut torque	105 N•m (10.7 kgf•m, 77 ft•lbf)		

▶ 18 inch tires

Tire size	265/60R18 110H		
Tire inflation pressure (Recommended cold tire inflation pressure)	Front wheel kPa (kgf/cm ² or bar, psi)	Rear wheel (unladen) kPa (kgf/cm ² or bar, psi)	Rear wheel (full load) kPa (kgf/cm ² or bar, psi)
	Without stop & start system	200 (2.0, 29)	200 (2.0, 29)
With stop & start system	230 (2.3, 33)	230 (2.3, 33)	250 (2.5, 36)
Wheel size	18 × 7 1/2J		
Wheel nut torque	105 N•m (10.7 kgf•m, 77 ft•lbf)		

■ When towing a trailer (models for model code destination W*)

Add 20.0 kPa (0.2 kgf/cm² or bar, 3 psi) to the recommended tire inflation pressure and drive at speeds below 100 km/h (62 mph).

*: See "Checking your vehicle's model" if you are not sure of which model your vehicle is. (→P. 11)

Light bulbs

	Light bulbs	W	Type
Exterior	Headlights High/low beams (halogen headlights) High beams (LED headlights)	60/55 60	A B
	Front fog lights* ¹	19	C
	Front position lights (halogen headlights) Without daytime running lights With daytime running lights	5 21/5	D D
	Front turn signal lights Halogen headlights LED headlights	21 21	E F
	Rear turn signal lights	21	E
	Back-up lights	21	G
	Rear fog light* ¹	21	G
	License plate light	5	D
	Stop/tail lights	21/5	G
	Interior	Interior light* ¹	8
Personal/interior lights		5 or 8* ²	D

A: H4 halogen bulbs

E: Single end bulbs (amber)

B: HB3 halogen bulbs

F: Wedge base bulbs (amber)

C: H16 halogen bulbs

G: Single end bulbs (clear)

D: Wedge base bulbs (clear)

H: Double end bulbs

*¹: If equipped

*²: The wattage differs depending on the specification. When replacing, use a light bulb with the same wattage as the original bulb.

Fuel information

◆ Gasoline engine

You must only use unleaded gasoline.

Select unleaded gasoline with a Research Octane Number of 91 or higher for optimum engine performance.

◆ Diesel engine

▶ EU area:

You must only use diesel fuel conforming to European standard EN590.

▶ Except EU area (except Russia):

You must only use diesel fuel with a cetane number of 48 or higher.

▶ Except EU area (Russia):

You must only use diesel fuel with a cetane number of 48 or higher.

Your vehicle must use only diesel fuel conforming to GOST R52368-2005.

■ Use of ethanol blended gasoline in a gasoline engine

Toyota allows the use of ethanol blended gasoline where the ethanol content is up to 10%. Make sure that the ethanol blended gasoline to be used has a Research Octane Number that follows the above.

■ If you plan to drive in foreign countries (vehicles with DPF system)

Low sulfur diesel fuel may not be available, so please check the availability with your distributor.

■ If your engine knocks

- Consult any authorized Toyota dealer or repairer, or another duly qualified and equipped professional.
- You may occasionally notice light knocking for a short time while accelerating or driving uphill. This is normal and there is no need for concern.

**NOTICE****■ Notice on gasoline fuel quality**

- Do not use improper fuels. If improper fuels are used, the engine will be damaged.
- Do not use leaded gasoline.
Leaded gasoline will cause the three-way catalytic converter to lose its effectiveness and the emission control system to function improperly.
- Do not use the methanol blended gasoline such as M15, M85, M100. The use of gasoline containing methanol may cause engine damage or failure.
- For Kazakhstan: Bioethanol fuel sold under names such as “E50” or “E85” and fuel containing a large amount of ethanol should not be used. Your vehicle can use gasoline mixed with 10% max ethanol. The use of fuel with more than 10% ethanol content (E10) will damage the vehicle’s fuel system. You must ensure that refueling is carried out only from a source where fuel specification and quality can be guaranteed. In case of any doubt, ask any authorized Toyota dealer or repairer, or another duly qualified and equipped professional.

■ Notice on diesel fuel quality

- Do not use improper fuels. If improper fuels are used, the engine will be damaged.
- EU area: FAME (Fatty Acid Methyl Ester) fuel sold under names such as “B30” or “B100” and fuel containing a large amount of FAME should not be used. The use of these fuels will damage the vehicle’s fuel system. In case of any doubt, ask any authorized Toyota dealer or repairer, or another duly qualified and equipped professional.



NOTICE

- Except EU area (except Russia and models for model code destination V and Blank*): FAME (Fatty Acid Methyl Ester) fuel sold under names such as “B30” or “B100” and fuel containing a large amount of FAME should not be used. Your vehicle can use diesel mixed with 5% max biodiesel FAME (B5). The use of fuel with more than 5% FAME content (B5) will damage the vehicle’s fuel system. You must ensure that refueling is carried out only from a source where fuel specification and quality can be guaranteed. In case of any doubt, ask any authorized Toyota dealer or repairer, or another duly qualified and equipped professional.
 - Except EU area (Russia): FAME (Fatty Acid Methyl Ester) fuel sold under name such as “B30” or “B100” and fuel containing a large amount of FAME should not be used. The use of these fuel will damage the vehicle’s fuel system. In case of any doubt, ask any authorized Toyota dealer or repairer, or another duly qualified and equipped professional.
- *: See “Checking your vehicle’s model” if you are not sure of which model your vehicle is. (→P. 11)

تلفن شبانه روزی: ۰۲۱-۸۸۸۶۲۰۸۵

FarmaSOS.com

Customizable features

Your vehicle includes a variety of electronic features that can be personalized to your preferences. The settings of these features can be changed using the multi-information display or at any authorized Toyota dealer or repairer, or another duly qualified and equipped professional.

Some function settings are changed simultaneously with other functions being customized. Contact any authorized Toyota dealer or repairer, or another duly qualified and equipped professional for further details.

Customizing vehicle features





■ Changing using the multi-information display

- ▶ Vehicles with multi-information display type A

- 1 Press the “DISP” button to display the “SETTINGS” screen while the vehicle is stopped, and then press and hold the “DISP” button to display the customize mode screen.
- 2 Press the “DISP” button and select the item, and then press and hold the “DISP” button.
- 3 Press the “DISP” button and select the desired setting, and then press and hold the “DISP” button.

To exit the customize mode, press the “DISP” button to select the “EXIT”, and then press and hold the “DISP” button.

- ▶ Vehicles with multi-information display type B

- 1 Use the meter control switches to select  while the vehicle is stopped, and then press  to display the customize mode screen.
- 2 Select the desired item, and then press .
- 3 Select the desired setting, and then press .

To go back to the previous screen or exit the customize mode, press .

Customizable features

- ① Settings that can be changed using the multi-information display
- ② Settings that can be changed by any authorized Toyota dealer or repairer, or another duly qualified and equipped professional

Definition of symbols: O = Available, – = Not available





■ Gauges, meters and multi-information display*1 (→P. 133, 136)

- ▶ Vehicles with multi-information display type A

Function*2	Default setting	Customized setting	①	②
Language*3	English	German	O	–
		French		
		Spanish		
		Italian		
		Russian		
		Turkish		
		Thai		
		Portuguese		
	Indonesian			
Units*3	km (L/100 km)	km (km/L)	O	–
		miles (MPG)		
Eco Driving Indicator Light*1	On (Self-lighting)	Off	O	–

▶ Vehicles with multi-information display type B

Function*2	Default setting	Customized setting	①	②
Language*3	English	German	○	-
		French		
		Spanish		
		Italian		
		Russian		
		Turkish		
		Thai		
		Portuguese		
		Indonesian		
		Arabic		
Units*3	km (L/100 km)	km (km/L)	○	-
		miles (MPG)		
Eco Driving Indicator Light*1	On (Self-lighting)	Off	○	-
 switch settings	Drive information 1	Desired status screen*4	○	-
Drive information 1	Current fuel economy	*5	○	-
	Average fuel economy		○	-
Drive information 2	Distance to empty	*5	○	-
	Average speed		○	-
Pop-up display*1	On	Off	○	-
Accent color*3	Light blue	Blue	○	-
		Orange		
		Yellow		

Function		Default setting	Customized setting	①	②
Eco Saving	Fuel consumption comparison	10.0	*6	O	—
	Fuel price	150	*6	O	—
	Currency* ³	 (No currency unit)	 (Baht)  (Rupiah)  (Euro)	O	—

*1: If equipped

*2: For details about each function: →P. 133, 136

*3: The default setting and the customized setting items that can be displayed vary according to country.

*4: Some status screens cannot be registered (indicated on multi-information display).

*5: Customized items are the following items except for default setting items: current fuel economy (bar type), current fuel economy (value type), average fuel economy (after reset), average fuel economy (after start), average fuel economy (after refuel), average speed (after reset), average speed (after start), elapsed time (after reset), elapsed time (after start), distance (range), distance (after start), blank.

*6: The values can be changed using the meter control switches.

■ RSA (Road Sign Assist)*1 (→P. 309)

Function		Default setting	Customized setting	①	②
RSA (Road Sign Assist)		On	Off	○	—
Notification method	Excess speed	Only visual	No notification	○	—
			Visual and audible*2		
	Others*3	Only visual	No notification	○	—
			Visual and audible*2		
Excess speed notification level		2 km/h (1 mph)	5 km/h (3 mph)	○	—
			10 km/h (5 mph)		

*1: If equipped

*2: If a speed limit with supplemental mark is exceeded, the warning buzzer does not operate.

*3: No-overtaking notification only

■ Stop & Start system* (→P. 348)

Function	Default setting	Customized setting	①	②
Idling stop	Normal	Long	○	—

*: If equipped

■ Door lock (→P. 163)

Function	Default setting	Customized setting	①	②
Speed linked door locking function* ¹	On	Off	–	O* ²
Driver's door linked door unlocking function* ¹	Off	On	–	O* ²

*¹: If equipped

*²: Setting that can be changed manually (→P. 164) or at any authorized Toyota dealer or repairer, or another duly qualified and equipped professional

■ Smart entry & start system* (→P. 170)

Function	Default setting	Customized setting	①	②
Smart entry & start system	On	Off	–	O
Operational signal (buzzer)*	Level 5	Off	–	O
		Level 1 to 7		

*: If equipped

■ Automatic light control system* (→P. 262)

Function	Default setting	Customized setting	①	②
Light sensor sensitivity	Standard	-2 to 2	–	O

*: If equipped

■ Turn signal lever (→P. 260)

Function	Default setting	Customized setting	①	②
Times of flashing of the lane change signal flashers	3	4	-	0
		5		
		6		
		7		
		Off		

WARNING

■ During customization

As the engine needs to be running during customization, ensure that the vehicle is parked in a place with adequate ventilation. In a closed area such as a garage, exhaust gases including harmful carbon monoxide (CO) may collect and enter the vehicle. This may lead to death or a serious health hazard.

NOTICE

■ During customization

To prevent battery discharge, ensure that the engine is running while customizing features.

تلفن شبانه روزی: ۰۸۵-۸۸۶۲۰۸۵
FarmaSOS.com

Items to initialize

The following items must be initialized for normal system operation after such cases as the battery is reconnected, or maintenance is performed on the vehicle.

Item	When to initialize	Reference
Engine oil maintenance data (if equipped)	After changing engine oil	P. 504
Tire pressure warning system (if equipped)	<ul style="list-style-type: none"> • When the tire inflation pressure is changed such as when changing traveling speed or load weight • When the tire inflation pressure is changed such as when the tire size is changed • When rotating the tires 	P. 520

تلفن شبانه روزی: ۰۲۱-۸۸۸۶۲۰۸۵

FarmaSOS.com

امداد خودرو فارما

تلفن شبانه روزی: ۰۲۱-۸۸۸۶۲۰۸۵

FarmaSOS.com

Index

What to do if... (Troubleshooting).....	658
Alphabetical index	662

امداد خودرو فارما

تلفن شبانه روزی: ۰۲۱-۸۸۸۶۲۰۸۵

FarmaSOS.com

For vehicles with navigation system or multimedia system, refer to the "Navigation and multimedia system Owner's manual" for information regarding the equipment listed below.

- Navigation system
- Audio system
- Hands-free system (for cellular phone)

What to do if... (Troubleshooting)

If you have a problem, check the following before contacting any authorized Toyota dealer or repairer, or another duly qualified and equipped professional.

The doors cannot be locked, unlocked, opened or closed



You lose your keys

- If you lose your keys or mechanical keys, new genuine keys or mechanical keys can be made by any authorized Toyota dealer or repairer, or another duly qualified and equipped professional. (→P. 152)
- Vehicles with smart entry & start system:
If you lose your electronic keys, the risk of vehicle theft increases significantly. Contact any authorized Toyota dealer or repairer, or another duly qualified and equipped professional immediately. (→P. 159)



The doors cannot be locked or unlocked

- Is the key battery weak or depleted? (→P. 532)
- Vehicles with smart entry & start system:
Is the engine switch in IGNITION ON mode?
When locking the doors, turn the engine switch off. (→P. 242)
- Vehicles with smart entry & start system:
Is the electronic key left inside the vehicle?
When locking the doors, make sure that you have the electronic key on your person.
- The function may not operate properly due to the condition of the radio wave. (→P. 165, 173)



The rear door cannot be opened (vehicles with rear door child-protector lock)

- Is the rear door child-protector lock set?
The rear door cannot be opened from inside the vehicle when the lock is set. Open the rear door from outside and then unlock the rear door child-protector lock. (→P. 163)

If you think something is wrong



The engine does not start (vehicles without smart entry & start system)

- Vehicles with manual transmission:
Do you turn the key with the clutch pedal depressed firmly? (→P. 236)
- Vehicles with automatic transmission:
Is the shift lever in P? (→P. 236)
- Is the steering wheel unlocked? (→P. 238)
- Is the battery discharged? (→P. 607)



The engine does not start (vehicles with smart entry & start system)

- Did you press the engine switch while firmly depressing the brake pedal?
(→P. 239)
- Vehicles with automatic transmission:
Is the shift lever in P? (→P. 239)
- Is the electronic key anywhere detectable inside the vehicle? (→P. 171)
- Is the steering wheel unlocked? (→P. 244)
- Is the electronic key battery weak or depleted?
In this case, the engine can be started in a temporary way. (→P. 604)
- Is the battery discharged? (→P. 607)



The shift lever cannot be shifted from P even if you depress the brake pedal (vehicles with automatic transmission)

- Vehicles without smart entry & start system:
Is the engine switch in the "ON" position?
If you cannot release the shift lever by depressing the brake pedal with the engine switch in the "ON" position: →P. 252
- Vehicles with smart entry & start system:
Is the engine switch in IGNITION ON mode?
If you cannot release the shift lever by depressing the brake pedal with the engine switch in IGNITION ON mode: →P. 252



The steering wheel cannot be turned after the engine is stopped

- Vehicles without smart entry & start system:
It is locked to prevent theft of the vehicle if the key is removed from the engine switch. (→P. 238)
- Vehicles with smart entry & start system:
It is locked automatically to prevent theft of the vehicle. (→P. 244)



The windows do not open or close by operating the power window switches (if equipped)

- Is the window lock switch pressed?
The power window except for the one at the driver's seat cannot be operated if the window lock switch is pressed. (→P. 201)



The engine switch is turned off automatically (vehicles with smart entry & start system)

- The auto power off function will be operated if the vehicle is left in ACCESSORY or IGNITION ON mode (the engine is not operating) for a period of time. (→P. 243)



A warning buzzer sounds during driving

- The seat belt reminder light is flashing
Are the driver and passengers wearing the seat belts? (→P. 571)
- The parking brake indicator light is on
Is the parking brake released? (→P. 261)

Depending on the situation, other types of warning buzzer may also sound. (→P. 567, 577)



An alarm is activated and the horn sounds (if equipped)

- Did anyone inside the vehicle open a door during setting the alarm?
The sensor detects it and the alarm sounds. (→P. 116)

To stop the alarm, turn the engine switch to the "ON" position (vehicles without smart entry & start system) or IGNITION ON mode (vehicles with smart entry & start system) or start the engine.

**A warning buzzer sounds when leaving the vehicle
(vehicles with smart entry & start system)**

- Is the message displayed on the multi-information display?
Check the message on the multi-information display.

**A warning light turns on or a warning message is displayed**

- When a warning light turns on or a warning message is displayed, refer to P. 567, 577.

When a problem has occurred**If you have a flat tire**

- Stop the vehicle in a safe place and replace the flat tire with the spare tire.
(→P. 584)

**The vehicle becomes stuck**

- Try the procedure for when the vehicle becomes stuck in mud, dirt, or snow. (→P. 617)

Alphabetical index

A

- A/C**..... **448, 456**
- Air conditioning filter..... 530
 - Automatic air conditioning system 456
 - Manual air conditioning system 448
- ABS (Anti-lock Brake System)** **353**
- Function 353
 - Warning light 568
- Access panels** **166**
- AdBlue™** **513**
- Capacity 515
 - Low AdBlue™ level warning light 572
 - Refilling 515
- Air conditioning filter** **530**
- Air conditioning system** **448, 456**
- Air conditioning filter..... 530
 - Automatic air conditioning system 456
 - Manual air conditioning system 448
- Airbags** **45**
- Airbag manual on-off system 62
 - Airbag operating conditions 52
 - Airbag precautions for your child 47
 - Airbag warning light 568
 - Correct driving posture..... 38
 - Curtain shield airbag operating conditions 53
 - Curtain shield airbag precautions 49
 - Front passenger occupant classification system..... 57
 - General airbag precautions..... 47
 - Locations of airbags..... 45
 - Modification and disposal of airbags 51
 - Side airbag operating conditions 53
 - Side airbag precautions 49
 - Side and curtain shield airbags operating conditions 53
 - Side and curtain shield airbags precautions 49
 - SRS airbags..... 45
- Airbag manual on-off system** **62**
- Alarm** **116**
- Antenna** **386, 486**
- Antennas (smart entry & start system)**..... **170**
- Anti-lock brake system (ABS)** **353**
- Function 353
 - Warning light..... 568
- Armrest**..... **482**
- Audio input*** **397, 405, 412**
- Audio system** **374**
- Antenna 386, 486
 - Audio input..... 379
 - AUX port 379
 - Bluetooth® audio..... 433
 - CD player 387
 - iPod..... 397
 - MP3/WMA disc 387
 - Optimal use..... 380
 - Portable music player..... 412
 - Radio 382
 - Steering wheel audio switches..... 376
 - USB memory 405

Automatic air conditioning system	
Air conditioning filter.....	530
Automatic air conditioning system.....	456
Automatic disconnecting differential.....	329
Automatic light control system.....	266
Automatic transmission.....	247
If the shift lever cannot be shifted from P.....	252
AUX port*.....	412
Auxiliary boxes.....	473

B

Back window.....	205
Back-up lights	
Replacing light bulbs.....	551
Wattage.....	644
Battery	
Battery checking.....	507
If the vehicle battery is discharged.....	607
Preparing and checking before winter.....	368
Warning light.....	567
Bluetooth®*.....	440
Audio system.....	433
Hands-free system (for cellular phone).....	413
Registering/removing a Bluetooth® device.....	421
Selecting a Bluetooth® device.....	422, 423
Wireless communication.....	413
Bluetooth® audio*.....	413

Bluetooth® phone*.....	413
Deleting the call history.....	428
Making a call.....	435
Managing speed dials.....	435
Managing the contacts.....	430
Phone settings.....	426
Receiving a call.....	437
Speaking on the phone.....	435
Bottle holders.....	472
Brake	
Fluid.....	641
Override system warning light.....	570
Parking brake.....	261
Warning light.....	567
Brake assist.....	353
Break-in tips.....	211
Brightness control	
Instrument panel light control.....	130

C

Care	
Aluminum wheels.....	487
Exterior.....	486
Interior.....	489
Seat belts.....	490
CD player*.....	387
Chains.....	369
Child restraint system.....	65
Child seats definition.....	67
Child seats installation.....	80, 95
Installing CRS with ISOFIX rigid anchor.....	91
Installing CRS with seat belts.....	73
Installing CRS with top strap.....	104

*: Refer to "Navigation and multimedia system Owner's manual".

Child safety	64
Airbag precautions	47
Battery precautions	510, 611
Child restraint system	65
How your child should wear the seat belt	42
Installing child restraints.....	80, 95
Power window lock switch.....	201
Power window precautions ...	203
Rear door child-protectors	163
Removed key battery precautions	534
Seat belt precautions	44
Seat heater precautions.....	465
Child-protectors	163
Cleaning	486, 489
Aluminum wheels.....	487
Exterior.....	486
Interior.....	489
Seat belts	490
Clock	478
Clutch	640
Coat hooks	482
Condenser	506
Console box	470
Cooling system	
Engine overheating	613
Cruise control	314
Cup holders	471
Curtain shield airbags	45

D

DAC	361
Daytime running light system	266
Deck hooks	476
Defogger	
Outside rear view mirrors	449, 458
Rear window	449, 458
Windshield	449, 458
Differential	
Oil	640
Dimension	620
Display	
LDA (Lane Departure Alert).....	310
Multi-information display	133, 136
Trip information.....	134, 138
Do-it-yourself maintenance	495
Doors	
Door glasses.....	200
Door lock.....	160
Open door warning light.....	571
Outside rear view mirrors.....	197
Rear door child-protectors	163
Side doors.....	160
Downhill assist control system	361
DPF (Diesel Particulate Filter) system	364
Warning message.....	581
Driver's seat belt reminder light	571
Driving	
Break-in tips	211
Correct posture	38
Procedures	208
Winter drive tips	368

E

Eco Driving Indicator..... 124, 126

Emergency flashers..... 556

Electronic key

- If the electronic key does not operate properly 603
- Replacing the battery 532

Emergency, in case of

- If a warning buzzer sounds 567
- If a warning light turns on 567
- If the electronic key does not operate properly 603
- If the engine will not start 601
- If the vehicle battery is discharged 607
- If you have a flat tire 584
- If you lose your keys 152
- If you run out of fuel and the engine stalls 616
- If you think something is wrong 564
- If your vehicle becomes stuck 617
- If your vehicle has to be stopped in an emergency 557
- If your vehicle needs to be towed 559
- If your vehicle overheats 613

Engine

- “ACC” position 237
- Compartment 499
- Engine switch 236, 239
- Hood 497
- How to start the engine 236, 239
- Identification number 625
- If the engine will not start 601
- If you run out of fuel and the engine stalls 616
- If your vehicle has to be stopped in an emergency 557
- Ignition switch (engine switch) 236, 239
- Overheating 613

Engine coolant

- Capacity 636
- Checking 505
- Preparing and checking before winter 368

Engine coolant

temperature gauge..... 130

Engine immobilizer system 107

Engine oil

- Capacity 628
- Checking 502
- Oil level warning light 571
- Oil pressure warning light 567
- Preparing and checking before winter 368

Engine oil maintenance

data..... 504

Engine switch	
(ignition switch)	236, 239
Auto power off function	243
Changing the engine	
switch modes.....	242
Changing the engine	
switch position	237
If your vehicle has to be	
stopped in an	
emergency.....	557
Starting the engine.....	236, 239
Engine switch light	
(ignition switch light)	466
ERA-GLONASS	483

F

Fire extinguisher	566
Flat tire	584
Floor mat	36
Fluid	
Automatic transmission.....	638
Brake.....	641
Clutch.....	640
Steering.....	642
Transfer.....	639
Washer.....	511
Fog lights	
Replacing light bulbs.....	548, 551
Switch	269
Wattage.....	644
Four-wheel drive system	
Front-wheel drive control	
switch.....	329
Warning light	569
Front fog lights	
Replacing light bulbs.....	548
Switch	269
Wattage.....	644

Front passenger occupant	
classification system	57
Front position lights	
Light switch	262
Replacing light bulbs.....	544
Wattage	644
Front seats	
Adjustment.....	186
Cleaning.....	489
Correct driving posture	38
Head restraints	191
Seat heaters	465
Front turn signal lights	
Replacing light bulbs.....	545
Turn signal lever	260
Wattage	644
Fuel	
Capacity.....	627
Fuel filter	512
Fuel gauge.....	129
Fuel pump shut off system....	565
Gas station information.....	676
If you run out of fuel	
and the engine stalls	616
Information.....	645
Refueling.....	274
Type.....	627
Warning light.....	569
Fuel consumption	
information	144
Fuel filler door	274
Refueling.....	274
Fuel filter	512, 569
Fuel pump shut off system	565
Fuses	535

G

Gauges.....	128
Glove box	470
Grocery bag hooks	481

H

Hands-free system (for cellular phone)*	413
Head restraints.....	191
Headlights	262
Light switch	262
Replacing light bulbs.....	542
Wattage.....	644
Heaters	
Automatic air conditioning system	456
Manual air conditioning system	448
Seat heaters.....	465
Outside rear view mirrors.....	458
High mounted stoplight	
Replacing	553
Hill-start assist control.....	353
Hood.....	497
Hooks	
Coat hooks.....	482
Grocery bag hooks.....	481
Retaining hooks (floor mat).....	36
Horn	195

I

Identification	
Engine.....	625
Vehicle.....	623
Ignition switch (engine switch).....	236, 239
Auto power off function.....	243
Changing the engine switch modes.....	242
Changing the engine switch position.....	237
If your vehicle has to be stopped in an emergency.....	557
Starting the engine.....	236, 239
Ignition switch light (engine switch light)	466
Illuminated entry system	468
Immobilizer system	107
Indicators	120
Initialization	
Engine oil maintenance data	504
Items to initialize	655
Tire pressure warning system	520
Inside rear view mirror	196
Instrument panel light control	130
Intercooler	506
Interior lights.....	466
Switch	467
Wattage	644

J

Jack	
Vehicle-equipped jack.....	585
Jack handle	590
Jam protection function	
Power windows.....	201

*: Refer to "Navigation and multimedia system Owner's manual".

K**Keyless entry**

- Smart entry & start system.... 160
- Wireless remote control 150

Keys 148

- Electronic key..... 148
- Engine switch..... 236
- If the electronic key does
 - not operate properly 603
- If you lose your keys 152
- Key number plate..... 148
- Keyless entry 150
- Keys 148
- Replacing the battery 532
- Wireless remote
 - control key 150

L**Lever**

- Auxiliary catch lever 497
- Hood lock release lever 497
- Shift lever 247, 254
- Turn signal lever 260
- Wiper lever 271

LDA (Lane Departure Alert) 300**License plate light**

- Light switch 262
- Replacing light bulbs 552
- Wattage..... 644

Light

- Engine switch light 466
- Fog light switch 269
- Headlight switch 262
- Illuminated entry system 468
- Interior lights 467
- Interior light list..... 466
- Personal/interior lights 467
- Replacing light bulbs 540
- Turn signal lever 260
- Wattage..... 644

Light bulbs

- Replacing..... 540
- Wattage 644

Lock steering column 238, 244**M****Maintenance**

- Do-it-yourself maintenance ... 495
- Maintenance data 620
- Maintenance requirements ... 492

Malfunction indicator lamp..... 568**Manual headlight**

- leveling dial..... 264

Manual transmission..... 254**Master warning light..... 571****Meter**

- Indicators 120
- Instrument panel light
 - control..... 130
- Meters 128
- Multi-information
 - display 133, 136
 - Warning lights 567

Microphone 416**Mirrors**

- Inside rear view mirror 196
- Outside rear view mirror
 - defoggers 449, 458
- Outside rear view mirrors..... 197
- Vanity mirror 477

MP3 disc* 390**Multimedia system*****Multi-information display**

- LDA (Lane Departure
 - Alert)..... 303
- Switching the display 134
- Trip information 134

N**Navigation system***

O

Odometer	130
Oil	
Differential oil	640
Engine oil	628
Manual transmission oil	639
Transfer oil	639
Opener	
Fuel filler door	274
Hood	497
Outside rear view mirrors	197
Adjusting and folding.....	197
Outside rear view mirror defoggers.....	458
Outside temperature display	129
Overhead console	473
Overheating, Engine	613

P

Parking brake	261
Operation	261
Parking brake indicator light.....	572
PCS (Pre-Crash Safety system)	287
Enabling/disabling the system	291
Function	287
Warning light	570
Warning message	582
Personal lights	466
Switch	467
Wattage.....	644
Power heater	450
Power outlets	479
Power steering	
Fluid	642

Power windows

Jam protection function.....	201
Operation	200
Window lock switch.....	201

Pre-Crash Safety system

(PCS)	287
Enabling/disabling the system	291
Function	287
Warning light.....	570
Warning message	582

Q

Quarter windows	204
------------------------------	-----

R

Radiator	506
Radio *	382
Radio data system *	384
RDS *	384
Rear differential lock system	339
Rear fog light	
Replacing light bulb	551
Switch	269
Wattage	644
Rear passengers' seat belt reminder light	571
Rear seat	
Removing the rear seat cushions	188
Raising the bottom cushion	188
Rear step bumper	168
Rear turn signal lights	
Replacing light bulbs.....	551
Turn signal lever	260
Wattage	644

*: Refer to "Navigation and multimedia system Owner's manual".

Rear view mirror

Inside rear view mirror 196

Outside rear view mirrors 197

Rear view monitor system 318**Rear window defogger 449, 458****Refueling 274**

Capacity 627

Fuel types 627

Opening the fuel tank cap 274

Replacing

Electronic key battery 532

Fuses 535

Light bulbs 540

Tires 584

Wireless remote control
battery 532

Reset the maintenance data ... 504**Road Sign Assist 309****RSA (Road Sign Assist) 309****S****Seat belts 40**

Adjusting the seat belt 41

Child restraint system
installation 65

Cleaning and maintaining the
seat belt 490

Emergency Locking
Retractor 42

How to wear your seat belt 38

How your child should
wear the seat belt 42

Pregnant women, proper
seat belt use 43

Reminder light and
buzzer 571

Seat belt pretensioners 42

SRS warning light 568

Seat heaters 465**Seats**

Adjustment 186

Adjustment precautions 187

Child seats/child restraint
system installation 65

Cleaning 489

Head restraint 191

Properly sitting in the seat 38

Raising the bottom
cushion 188

Removing the rear seat
cushions 188

Seat heaters 465

Sensor

Automatic headlight
system 266

LDA (Lane Departure
Alert) 300

Service reminder

indicators 120

Shift lever

Automatic transmission 247

If the shift lever cannot be
shifted from P 252

Manual transmission 254

Shift lock system 251**Side airbags 45****Side doors 160****Side mirrors 197**

Adjusting and folding 197

Heaters 449, 458

Side turn signal lights

Replacing light bulbs 553

Turn signal lever 260

Smart entry & start system 170

Antenna location 170

Entry functions 160

Starting the engine 239

Warning message 577

Snow tires	368
“SOS” button	483
Spare tire	
Inflation pressure	642
Storage location	584
Spark plug	637
Specifications	620
Speedometer	129
Steering	
Column lock release	238, 244
Fluid	642
Steering wheel	
Adjustment	194
Audio switches	376
Meter control switches	137
Stop & Start system	343
Stop lights	
Replacing light bulbs.....	551
Wattage.....	644
Storage feature	469
Storage precautions	469
Stuck	
If your vehicle becomes stuck	617
Sun visors	477
Switch	
Audio remote control switches *	376
Cruise control switch.....	314
“DISP” button	134
Door lock switch.....	162
Emergency flashers switch ..	556
Engine switch.....	236, 239
Fog light switch	269
Front-wheel drive control switch.....	329
Heater idle up switch.....	450
Ignition switch	236, 239

LDA (Lane Departure Alert).....	303
Light switches	262
Meter control switches.....	137
Outside rear view mirror switches.....	197
Power door lock switch.....	162
Power window switch.....	200
Rear differential lock switch	339
Rear window and outside rear view mirror defoggers switch	449, 458
Seat heater switches	465
“SOS” button.....	483
Talk switch*	
Telephone switches*	418
Tire pressure warning reset switch	520
Window lock switch.....	201
Windshield wipers and washer switch.....	271

T

Tachometer	129
Tailgate	167
Tail lights	
Light switch	262
Replacing light bulbs.....	551
Wattage	644
Talk switch*	
Telephone switches*	418
Theft deterrent system	
Alarm	116
Engine immobilizer system ...	107
Tire inflation pressure	
Maintenance data	642
Warning light.....	572

*: Refer to “Navigation and multimedia system Owner’s manual”.

Warning lights

ABS.....	568
Brake Override system	570
Brake system.....	567
Charging system.....	567
Electronic engine control system.....	568
Four-wheel drive system.....	569
Fuel system.....	569
Go to service.....	574
Lane departure.....	571
Low AdBlue™.....	572
Low engine oil level.....	571
Low engine oil pressure.....	567
Low fuel level.....	571
Malfunction indicator lamp	568
Master warning light.....	571
Open door.....	571
Parking brake.....	572
Pre-Crash Safety system.....	570
Seat belt reminder light.....	571
Slip indicator.....	568
SRS.....	568
Timing belt replacement.....	569
Tire pressure.....	572

Washer

Checking.....	511
Preparing and checking before winter.....	368
Switch.....	271

Washing and waxing..... 486**Weights..... 621****Wheels..... 528**

Replacing wheels.....	584
Size.....	642

Window glasses..... 200**Window lock switch..... 201****Windows**

Power windows.....	200
Rear window defogger.....	449, 458
Washer.....	271

Windshield wipers

Intermittent windshield wipers.....	271
--	-----

Winter driving tips..... 368**Wireless communication..... 413****Wireless remote control**

key	150
Locking/Unlocking.....	150
Replacing the battery.....	532

WMA disc*..... 387

*: Refer to "Navigation and multimedia system Owner's manual".

امداد خودرو فارما

تلفن شبانه روزی: ۰۲۱-۸۸۸۶۲۰۸۵

FarmaSOS.com

امداد خودرو فارما

تلفن شبانه روزی: ۰۲۱-۸۸۸۶۲۰۸۵

FarmaSOS.com

GAS STATION INFORMATION

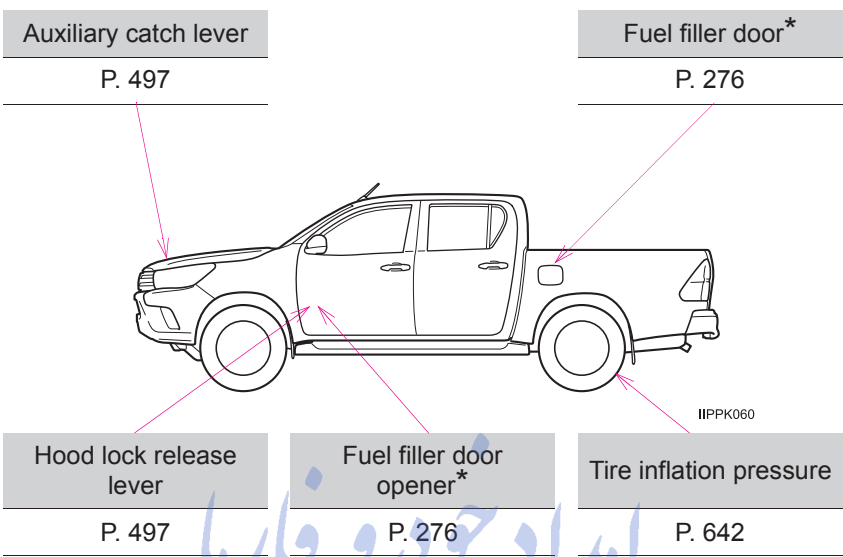

Fuel tank capacity (Reference)		80 L (21.1 gal., 17.6 Imp.gal.)	
Fuel type		P. 627	
Cold tire inflation pressure		P. 642	
Engine oil capacity (Drain and refill — reference)	Gasoline engine	With filter	L (qt., Imp. qt.) 5.6 (5.9, 4.9)
		Without filter	5.3 (5.6, 4.7)
	Diesel engine	▶ 1GD-FTV and 2GD-FTV engines	
		With filter	7.5 (7.9, 6.6)
	Without filter	7.0 (7.4, 6.2)	
		▶ 2KD-FTV engine	
		With filter	6.9 (7.3, 6.1)
		Without filter	6.6 (7.0, 5.8)
Engine oil type		P. 628	

*: If equipped